

MC3346

General Purpose Transistor Array One Differentially Connected Pair and Three Isolated Transistor Arrays

The MC3346 is designed for general purpose, low power applications for consumer and industrial designs.

- Guaranteed Base–Emitter Voltage Matching
- Operating Current Range Specified: 10 μ A to 10 mA
- Five General Purpose Transistors in One Package



ON Semiconductor®

<http://onsemi.com>

GENERAL PURPOSE TRANSISTOR ARRAY SEMICONDUCTOR TECHNICAL DATA

MAXIMUM RATINGS

Rating	Symbol	Value	Unit
Collector–Emitter Voltage	V_{CEO}	15	Vdc
Collector–Base Voltage	V_{CBO}	20	Vdc
Emitter–Base Voltage	V_{EB}	5.0	Vdc
Collector–Substrate Voltage	V_{CISO}	20	Vdc
Collector Current – Continuous	I_C	50	mA _{dc}
Total Power Dissipation @ $T_A = 25^\circ\text{C}$ Derate above 25°C	P_D	1.2 10	W mW/ $^\circ\text{C}$
Operating Temperature Range	T_A	-40 to +85	$^\circ\text{C}$
Storage Temperature Range	T_{stg}	-65 to +150	$^\circ\text{C}$

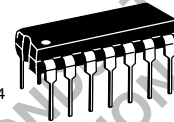

P SUFFIX
PLASTIC PACKAGE
CASE 646

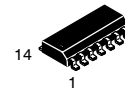

D SUFFIX
PLASTIC PACKAGE
CASE 751A
(SO-14)

PIN CONNECTIONS

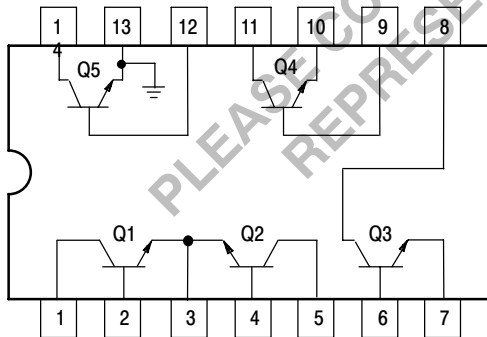

Pin 13 is connected to substrate and must remain at the lowest circuit potential.

ORDERING INFORMATION

Device	Operating Temperature Range	Package
MC3346D	$T_A = -40^\circ$ to $+85^\circ\text{C}$	SO-14
MC3356P		Plastic DIP

MC3346

ELECTRICAL CHARACTERISTICS (T_A = +25°C, unless otherwise noted.)

Characteristics	Symbol	Min	Typ	Max	Unit
STATIC CHARACTERISTICS					
Collector–Base Breakdown Voltage (I _C = 10 μAdc)	V _{(BR)CBO}	20	60	–	Vdc
Collector–Emitter Breakdown Voltage (I _C = 1.0 mAdc)	V _{(BR)CEO}	15	–	–	Vdc
Collector–Substrate Breakdown Voltage (I _C = 10 μA)	V _{(BR)CIO}	20	60	–	Vdc
Emitter–Base Breakdown Voltage (I _E = 10 μAdc)	V _{(BR)EBO}	5.0	7.0	–	Vdc
Collector–Base Cutoff Current (V _{CB} = 10 Vdc, I _E = 0)	I _{CBO}	–	–	40	nAdc
DC Current Gain (I _C = 10 mAdc, V _{CE} = 3.0 Vdc) (I _C = 1.0 mAdc, V _{CE} = 3.0 Vdc) (I _C = 10 μAdc, V _{CE} = 3.0 Vdc)	h _{FE}	– 40 –	140 130 60	– – –	–
Base–Emitter Voltage (V _{CE} = 3.0 Vdc, I _E = 1.0 mAdc) (V _{CE} = 3.0 Vdc, I _E = 10 mAdc)	V _{BE}	– –	0.72 0.8	– –	Vdc
Input Offset Current for Matched Pair Q1 and Q2 (V _{CE} = 3.0 Vdc, I _C = 1.0 mAdc)	I _{IO1} – I _{IO2}	–	0.3	2.0	μAdc
Magnitude of Input Offset Voltage (V _{CE} = 3.0 Vdc, I _C = 1.0 mAdc)	–	–	0.5	5.0	mVdc
Temperature Coefficient of Base–Emitter Voltage (V _{CE} = 3.0 Vdc, I _C = 1.0 mAdc)	$\frac{\Delta V_{BE}}{D_T}$	–	–1.9	–	mV/°C
Temperature Coefficient	$\frac{ \Delta V_{IO} }{D_T}$	–	1.0	–	μV/°C
Collector–Emitter Cutoff Current (V _{CE} = 10 Vdc, I _B = 0)	I _{CEO}	–	–	0.5	μAdc
DYNAMIC CHARACTERISTICS					
Low Frequency Noise Figure (V _{CE} = 3.0 Vdc, I _C = 100 μAdc, R _S = 1.0 kΩ, f = 1.0 kHz)	NF	–	3.25	–	dB
Forward Current Transfer Ratio (V _{CE} = 3.0 Vdc, I _C = 1.0 mAdc, f = 1.0 kHz)	h _{FE}	–	110	–	–
Short Circuit Input Impedance (V _{CE} = 3.0 Vdc, I _C = 1.0 mAdc)	h _{ie}	–	3.5	–	kΩ
Open Circuit Output Impedance (V _{CE} = 3.0 Vdc, I _C = 1.0 mAdc)	h _{oe}	–	15.6	–	μmhos
Reverse Voltage Transfer Ratio (V _{CE} = 3.0 Vdc, I _C = 1.0 mAdc)	h _{re}	–	1.8	–	x10 ^{–4}
Forward Transfer Admittance (V _{CE} = 3.0 Vdc, I _C = 1.0 mAdc, f = 1.0 MHz)	y _{fe}	–	31–j1.5	–	–
Input Admittance (V _{CE} = 3.0 Vdc, I _C = 1.0 mAdc, f = 1.0 MHz)	y _{ie}	–	0.3 + j0.04	–	–
Output Admittance (V _{CE} = 3.0 Vdc, I _C = 1.0 mAdc, f = 1.0 MHz)	y _{oe}	–	0.001 + j0.03	–	–
Current–Gain – Bandwidth Product (V _{CE} = 3.0 Vdc, I _C = 3.0 mAdc)	f _T	300	550	–	MHz
Emitter–Base Capacitance (V _{EB} = 3.0 Vdc, I _E = 0)	C _{eb}	–	0.6	–	pF
Collector–Base Capacitance (V _{CB} = 3.0 Vdc, I _C = 0)	C _{cb}	–	0.58	–	pF
Collector–Substrate Capacitance (V _{CS} = 3.0 Vdc, I _C = 0)	C _{Cl}	–	2.8	–	pF

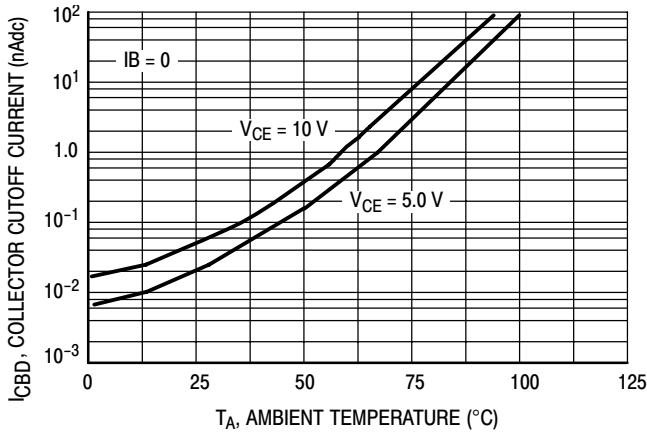

Figure 1. Collector Cutoff Current versus Temperature (Each Transistor)

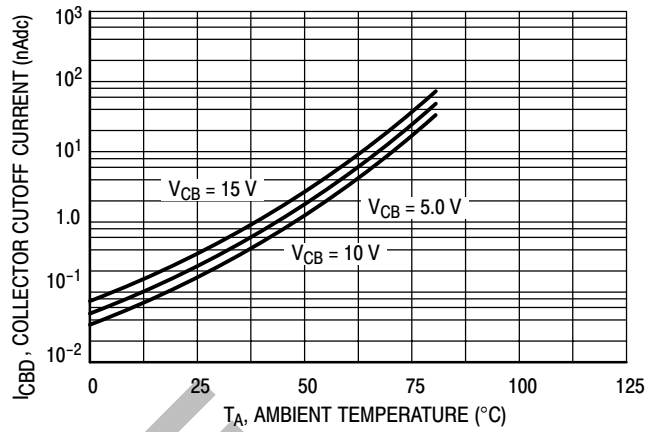

Figure 2. Collector Cutoff Current versus Temperature (Each Transistor)

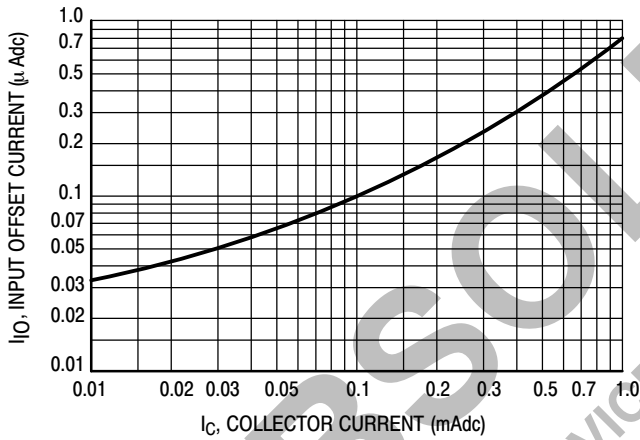

Figure 3. Input Offset Characteristics for Q1 and Q2

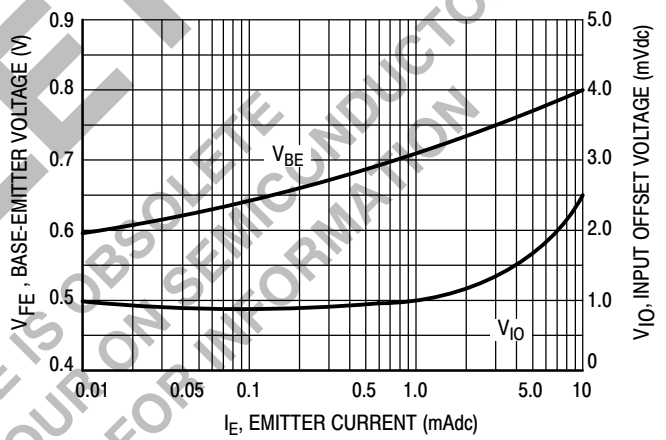

Figure 4. Base-Emitter and Input Offset Voltage Characteristics

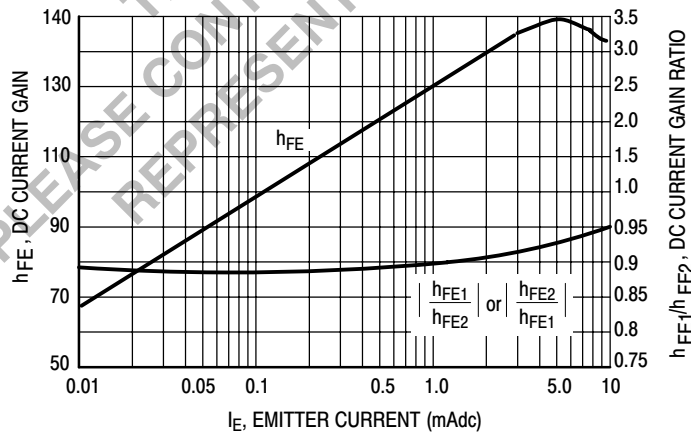
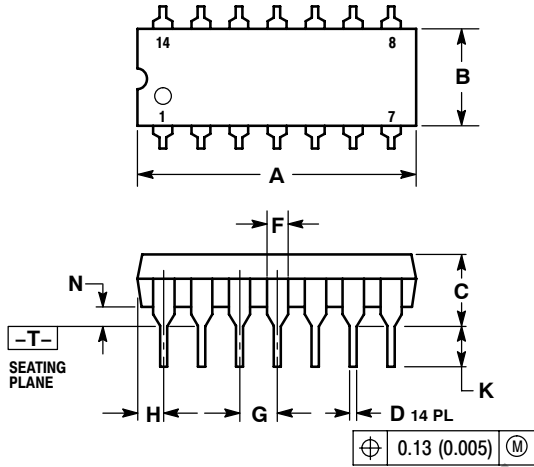

Figure 5. DC Current Gain

MC3346

PACKAGE DIMENSIONS

P SUFFIX
 PLASTIC PACKAGE
 CASE 646-06
 ISSUE M



NOTES:

1. DIMENSIONING AND TOLERANCING PER ANSI Y14.5M, 1982.
2. CONTROLLING DIMENSION: INCH.
3. DIMENSION L TO CENTER OF LEADS WHEN FORMED PARALLEL.
4. DIMENSION B DOES NOT INCLUDE MOLD FLASH.
5. ROUNDED CORNERS OPTIONAL.

DIM	INCHES		MILLIMETERS	
	MIN	MAX	MIN	MAX
A	0.715	0.770	18.16	18.80
B	0.240	0.260	6.10	6.60
C	0.145	0.185	3.69	4.69
D	0.015	0.021	0.38	0.53
F	0.040	0.070	1.02	1.78
G	0.100 BSC		2.54 BSC	
H	0.052	0.095	1.32	2.41
J	0.008	0.015	0.20	0.38
K	0.115	0.135	2.92	3.43
L	0.290	0.310	7.37	7.87
M	--- 10°		--- 10°	
N	0.015	0.039	0.38	1.01

OBSOLETE

THIS DEVICE IS OBSOLETE
 PLEASE CONTACT YOUR ON SEMICONDUCTOR
 REPRESENTATIVE FOR INFORMATION

MC3346

PACKAGE DIMENSIONS

D SUFFIX
PLASTIC PACKAGE
 CASE 751A-03
 (SO-8)
 ISSUE F

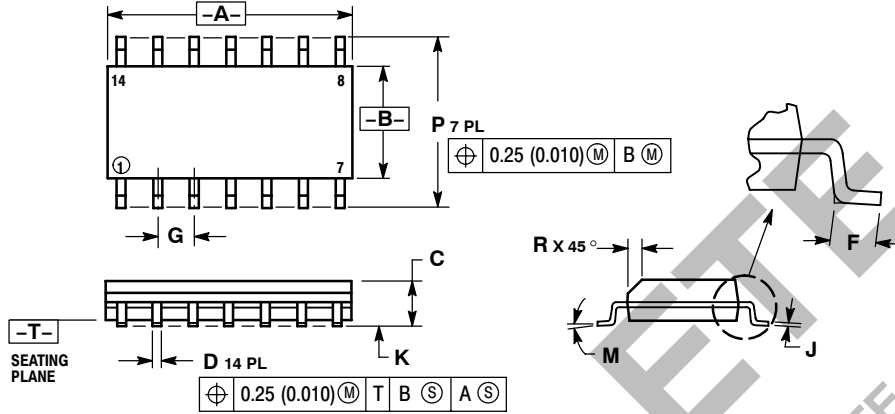

NOTES:

1. DIMENSIONING AND TOLERANCING PER ANSI Y14.5M, 1982.
2. CONTROLLING DIMENSION: MILLIMETER.
3. DIMENSIONS A AND B DO NOT INCLUDE MOLD PROTRUSION.
4. MAXIMUM MOLD PROTRUSION 0.15 (0.006) PER SIDE.
5. DIMENSION D DOES NOT INCLUDE DAMBAR PROTRUSION. ALLOWABLE DAMBAR PROTRUSION SHALL BE 0.127 (0.005) TOTAL IN EXCESS OF THE D DIMENSION AT MAXIMUM MATERIAL CONDITION.

DIM	MILLIMETERS		INCHES	
	MIN	MAX	MIN	MAX
A	8.55	8.75	0.337	0.344
B	3.80	4.00	0.150	0.157
C	1.35	1.75	0.054	0.068
D	0.35	0.49	0.014	0.019
F	0.40	1.25	0.016	0.049
G	1.27 BSC		0.050 BSC	
J	0.19	0.25	0.008	0.009
K	0.10	0.25	0.004	0.009
M	0°	7°	0°	7°
P	5.80	6.20	0.228	0.244
R	0.25	0.50	0.010	0.019

ON Semiconductor and **ON** are registered trademarks of Semiconductor Components Industries, LLC (SCILLC). SCILLC reserves the right to make changes without further notice to any products herein. SCILLC makes no warranty, representation or guarantee regarding the suitability of its products for any particular purpose, nor does SCILLC assume any liability arising out of the application or use of any product or circuit, and specifically disclaims any and all liability, including without limitation special, consequential or incidental damages. "Typical" parameters which may be provided in SCILLC data sheets and/or specifications can and do vary in different applications and actual performance may vary over time. All operating parameters, including "Typicals" must be validated for each customer application by customer's technical experts. SCILLC does not convey any license under its patent rights nor the rights of others. SCILLC products are not designed, intended, or authorized for use as components in systems intended for surgical implant into the body, or other applications intended to support or sustain life, or for any other application in which the failure of the SCILLC product could create a situation where personal injury or death may occur. Should Buyer purchase or use SCILLC products for any such unintended or unauthorized application, Buyer shall indemnify and hold SCILLC and its officers, employees, subsidiaries, affiliates, and distributors harmless against all claims, costs, damages, and expenses, and reasonable attorney fees arising out of, directly or indirectly, any claim of personal injury or death associated with such unintended or unauthorized use, even if such claim alleges that SCILLC was negligent regarding the design or manufacture of the part. SCILLC is an Equal Opportunity/Affirmative Action Employer. This literature is subject to all applicable copyright laws and is not for resale in any manner.

PUBLICATION ORDERING INFORMATION

LITERATURE FULFILLMENT:
 Literature Distribution Center for ON Semiconductor
 P.O. Box 5163, Denver, Colorado 80217 USA
Phone: 303-675-2175 or 800-344-3860 Toll Free USA/Canada
Fax: 303-675-2176 or 800-344-3867 Toll Free USA/Canada
Email: orderlit@onsemi.com

N. American Technical Support: 800-282-9855 Toll Free USA/Canada
Europe, Middle East and Africa Technical Support:
 Phone: 421 33 790 2910
Japan Customer Focus Center
 Phone: 81-3-5773-3850

ON Semiconductor Website: www.onsemi.com
Order Literature: <http://www.onsemi.com/orderlit>

For additional information, please contact your local Sales Representative