

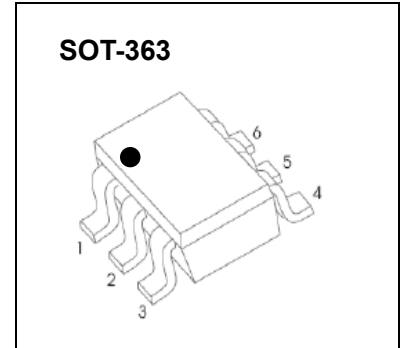

SOT-363 Plastic-Encapsulate MOSFETS

CJ7252KDW N Channel + P Channel Power MOSFET

$V_{(BR)DSS}$	$R_{DS(on)MAX}$	I_D
60V	5Ω@10V	0.34A
	5.3Ω@4.5V	
-50V	8Ω@-10V	-0.18A
	10Ω@-5V	



DESCRIPTION

This N Channel + P Channel MOSFET has been designed using advanced power trench process to optimize the $R_{DS(ON)}$.

FEATURE

- High-Side Switching
- Low Threshold
- Fast Switching Speed

APPLICATION

- Drivers:Relays, Solenoids, Memories
- Battery Operated Systems
- Power Supply Converter Circuits
- Load/Power Switching Cell Phones, Pagars

MARKING: 75

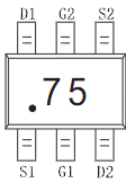

Equivalent Circuit

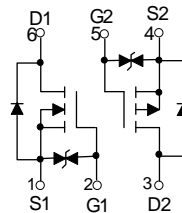

MAXIMUM RATINGS ($T_a=25^{\circ}C$ unless otherwise noted)

Symbol	Parameter	Value	Unit
N-Channel MOSFET			
V_{DS}	Drain-Source Voltage	60	V
V_{GS}	Gate-Source Voltage	±20	V
I_D	Drain Current -Continuous	0.34	A
I_{DM}	Drain Current - Pulsed(Note1)	1.36	A
P- Channel MOSFET			
V_{DS}	Drain-Source Voltage	-50	V
V_{GS}	Gate-Source Voltage	±20	V
I_D	Drain Current -Continuous	-0.18	A
I_{DM}	Drain Current – Pulsed (Note1)	-0.7	A
Power Dissipation, Temperature and Thermal Resistance			
P_D	Power Dissipation	0.15	W
$R_{\theta JA}$	Thermal Resistance from Junction to Ambient (Note2)	833	$^{\circ}C/W$
T_j	Junction Temperature	150	$^{\circ}C$
T_{stg}	Storage Temperature	-55~+150	$^{\circ}C$
T_L	Lead Temperature	260	$^{\circ}C$

MOSFET ELECTRICAL CHARACTERISTICS

$T_a=25^\circ\text{C}$ unless otherwise specified

Parameter	Symbol	Test conditions	Min	Typ	Max	Unit
N- Channel MOSFET						
Drain-source breakdown voltage	$V_{(BR)DSS}$	$V_{GS}=0V, I_D=250\mu A$	60			V
Zero gate voltage drain current	I_{DSS}	$V_{DS}=48V, V_{GS}=0V$			1	μA
Gate-body leakage current	I_{GSS}	$V_{GS}=\pm 20V, V_{DS}=0V$			± 10	μA
		$V_{GS}=\pm 10V, V_{DS}=0V$			± 200	nA
		$V_{GS}=\pm 5V, V_{DS}=0V$			± 100	nA
Gate threshold voltage (note 3)	$V_{GS(th)}$	$V_{DS}=V_{GS}, I_D=1mA$	1	1.3	2.5	V
Drain-source on-resistance (note 3)	$R_{DS(on)}$	$V_{GS}=4.5V, I_D=0.2A$		1.1	5.3	Ω
		$V_{GS}=10V, I_D=0.5A$		0.9	5	Ω
Diode forward voltage	V_{SD}	$I_S=0.3A, V_{GS}=0V$			1.5	V
DYNAMIC PARAMETERS (note 4)						
Input Capacitance	C_{iss}	$V_{DS}=10V, V_{GS}=0V, f=1MHz$			40	pF
Output Capacitance	C_{oss}				30	pF
Reverse Transfer Capacitance	C_{rss}				10	pF
SWITCHING PARAMETERS (note 4)						
Turn-on delay time	$t_{d(on)}$	$V_{GS}=10V, V_{DD}=50V,$ $R_L=250\Omega, R_{GEN}=50\Omega,$			10	ns
Turn-off delay time	$t_{d(off)}$				15	ns
Reverse recovery time	t_{rr}	$I_S=300mA;$ $d_{IS}/d_t=-100A/s; V_{GS}=0V;$ $V_R=25V$		30		ns
Recovered charge	Q_r			30		nC
P- Channel MOSFET						
Drain-source breakdown voltage	$V_{(BR)DSS}$	$V_{GS}=0V, I_D=-250\mu A$	-50			V
Zero gate voltage drain current	I_{DSS}	$V_{DS}=-50V, V_{GS}=0V$			-15	μA
		$V_{DS}=-25V, V_{GS}=0V$			-0.1	μA
Gate-body leakage current	I_{GSS}	$V_{GS}=\pm 20V, V_{DS}=0V$			± 10	nA
Gate threshold voltage (note 3)	$V_{GS(th)}$	$V_{DS}=V_{GS}, I_D=-250\mu A$	-0.9	-1.62	-2	V
Drain-source on-resistance (note 3)	$R_{DS(on)}$	$V_{GS}=-5V, I_D=-0.1A$		5.5	10	Ω
		$V_{GS}=-10V, I_D=-0.1A$		4.1	8	Ω
Forward transconductance (note 3)	g_{FS}	$V_{DS}=-25V, I_D=-0.1A$	0.05			S
DYNAMIC CHARACTERISTICS (note 4)						
Input capacitance	C_{iss}	$V_{DS}=-5V, V_{GS}=0V, f=1MHz$		30		pF
Output capacitance	C_{oss}			10		pF
Reverse transfer capacitance	C_{rss}			5		pF
SWITCHING CHARACTERISTICS (note 4)						
Turn-on delay time	$t_{d(on)}$	$V_{DD}=-15V,$ $R_L=50\Omega, I_D=-2.5A$		2.5		ns
Turn-on rise time	t_r			1		ns
Turn-off delay time	$t_{d(off)}$			16		ns
Turn-off fall time	t_f			8		ns
SOURCE-DRAIN DIODE CHARACTERISTICS (note 4)						
Continuous Current	I_S				-0.18	A
Pulsed Current	I_{SM}				-0.7	A
Diode forward voltage (note 3)	V_{DS}	$I_S=-0.13A, V_{GS}=0V$			-2.2	V

- Note:**
- 1、 Surface mounted on FR-4 board using minimum pad size, 1oz copper
 - 2、 Repetitive Rating: Pulse width limited by maximum junction temperature.
 - 3、 Pulse test: pulse width $\leq 300\mu s$, duty cycle $\leq 2\%$
 - 4、 These parameters have no way to verify.

Typical Characteristics

N-Channel MOS

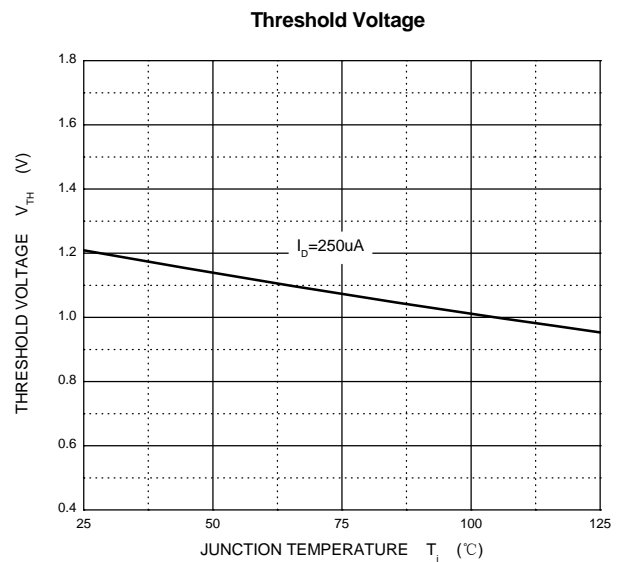
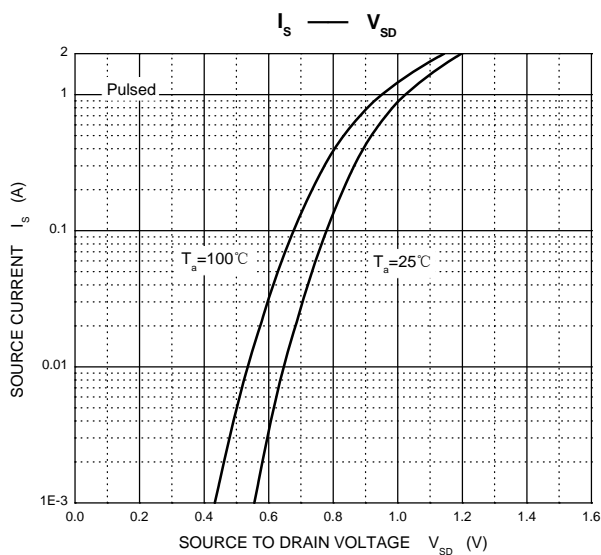
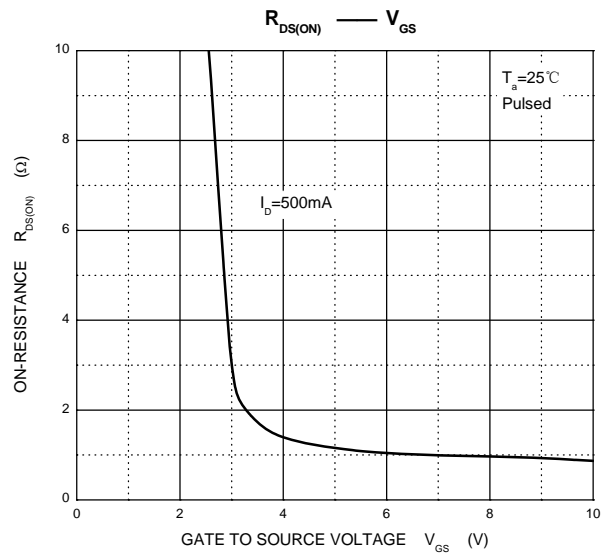
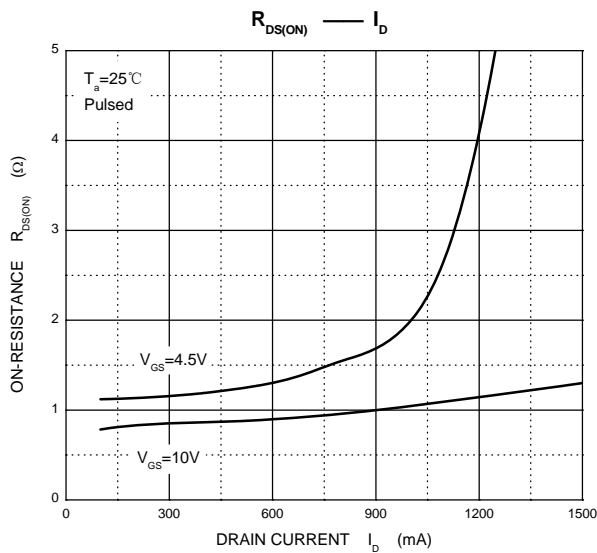
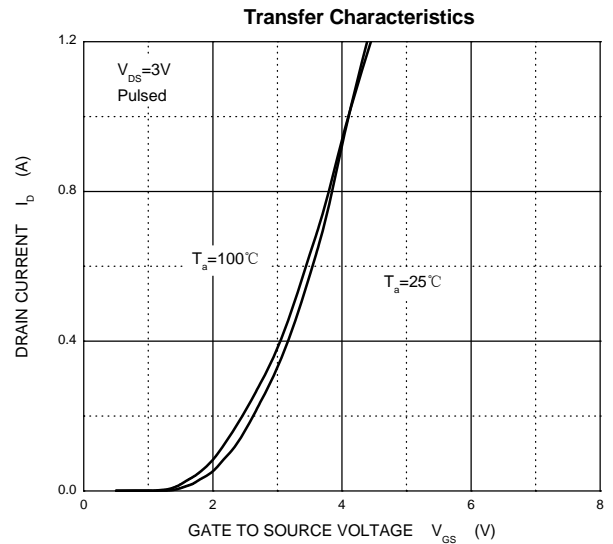
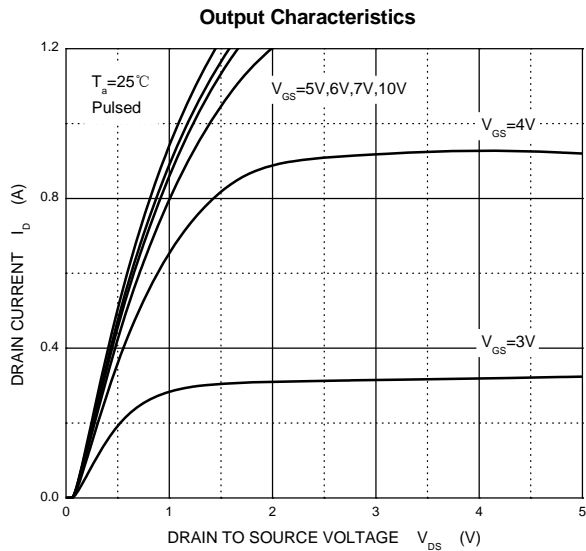

Typical Characteristics

P-Channel MOS

Output Characteristics

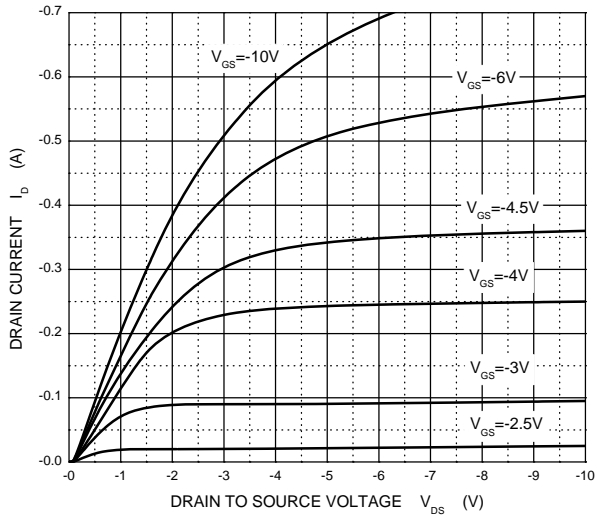

Transfer Characteristics

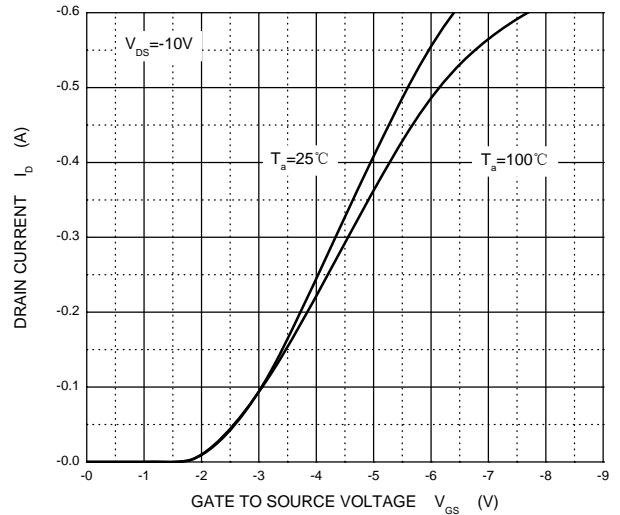

$R_{DS(ON)}$ — I_D

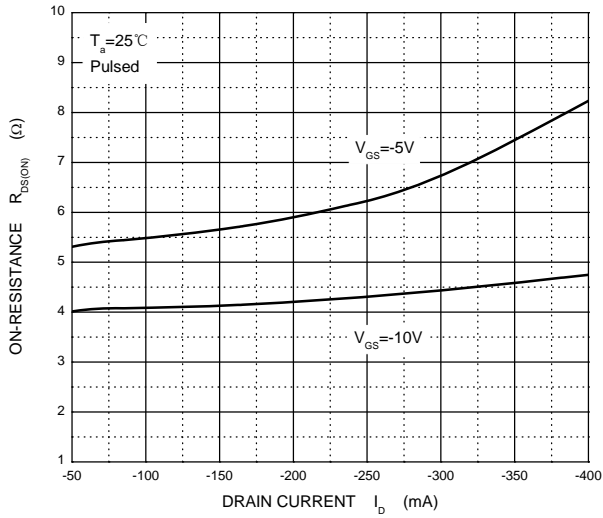

$R_{DS(ON)}$ — V_{GS}

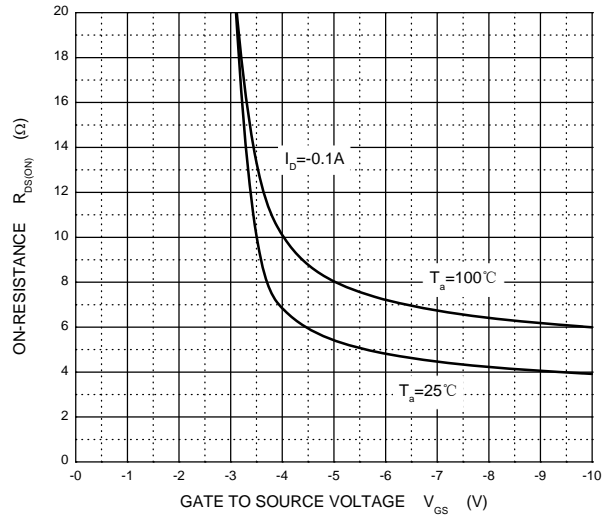

I_S — V_{SD}

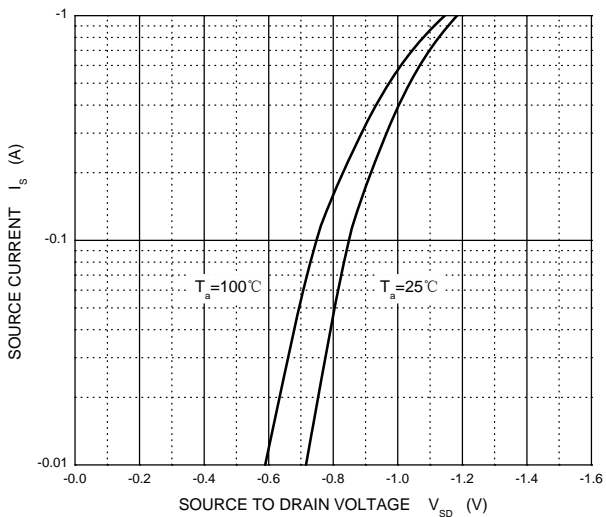

Threshold Voltage

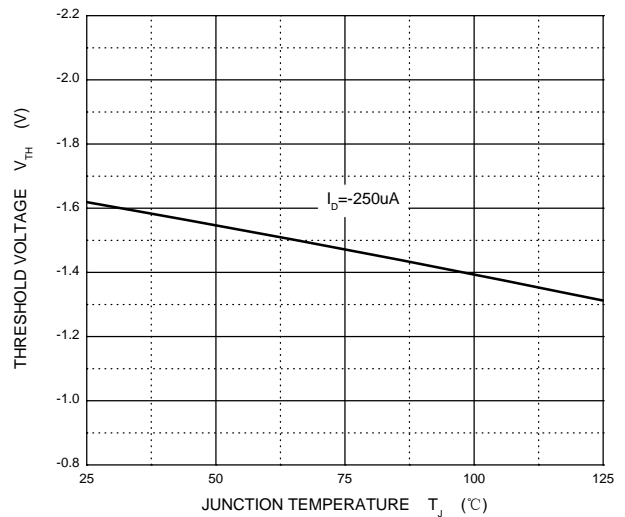

SOT-363 Package Outline Dimensions

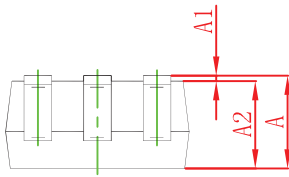
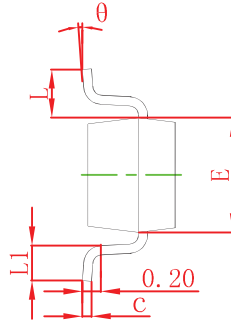
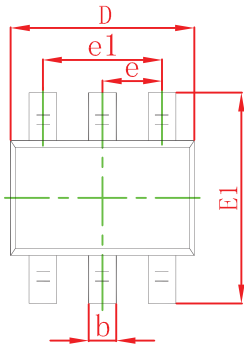

Symbol	Dimensions In Millimeters		Dimensions In Inches	
	Min	Max	Min	Max
A	0.900	1.100	0.035	0.043
A1	0.000	0.100	0.000	0.004
A2	0.900	1.000	0.035	0.039
b	0.150	0.350	0.006	0.014
c	0.100	0.150	0.004	0.006
D	2.000	2.200	0.079	0.087
E	1.150	1.350	0.045	0.053
E1	2.150	2.400	0.085	0.094
e	0.650 TYP		0.026 TYP	
e1	1.200	1.400	0.047	0.055
L	0.525 REF		0.021 REF	
L1	0.260	0.460	0.010	0.018
theta	0°	8°	0°	8°

SOT-363 Suggested Pad Layout

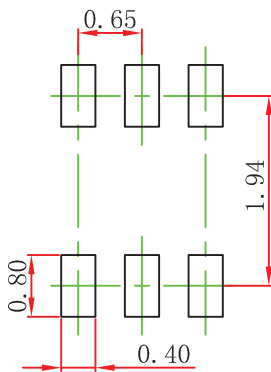

Note:

1. Controlling dimension: in millimeters.
2. General tolerance: $\pm 0.05\text{mm}$.
3. The pad layout is for reference purposes only.

NOTICE

JCET reserve the right to make modifications, enhancements, improvements, corrections or other changes without further notice to any product herein. JCET does not assume any liability arising out of the application or use of any product described herein.

SOT-363 Tape and reel

SOT-363 Embossed Carrier Tape

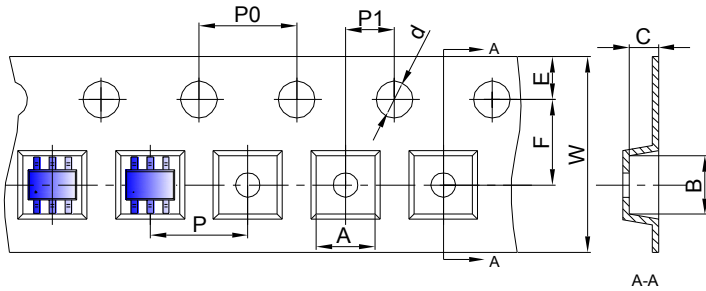

Packaging Description:
 SOT-363 parts are shipped in tape. The carrier tape is made from a dissipative (carbon filled) polycarbonate resin. The cover tape is a multilayer film (Heat Activated Adhesive in nature) primarily composed of polyester film, adhesive layer, sealant, and anti-static sprayed agent. These reeled parts in standard option are shipped with 3,000 units per 7" or 17.8cm diameter reel. The reels are clear in color and is made of polystyrene plastic (anti-static coated).

Dimensions are in millimeter										
Pkg type	A	B	C	d	E	F	P0	P	P1	W
SOT-363	2.25	2.55	1.20	Ø1.50	1.75	3.50	4.00	4.00	2.00	8.00

SOT-363 Tape Leader and Trailer

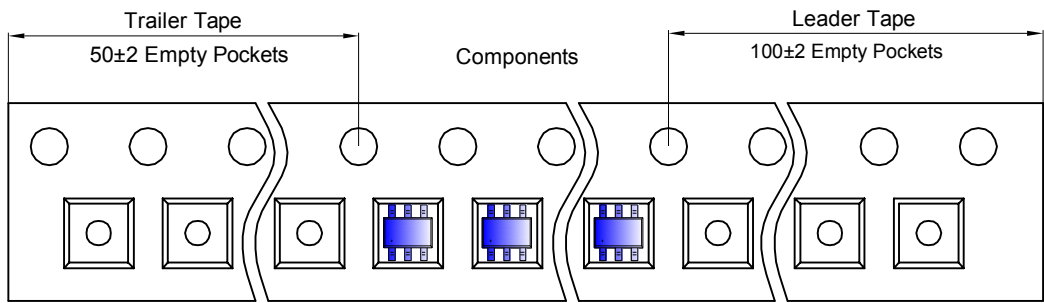

SOT-363 Reel

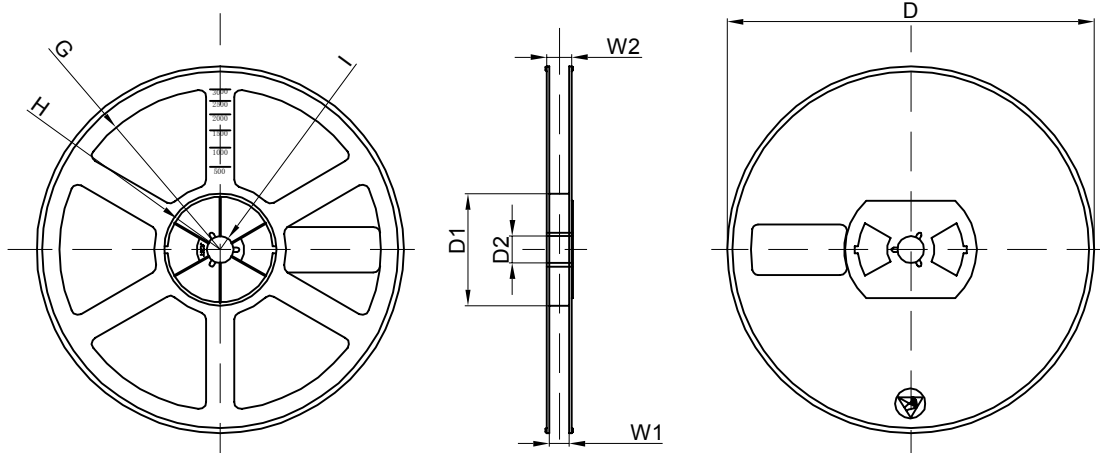

Dimensions are in millimeter								
Reel Option	D	D1	D2	G	H	I	W1	W2
7" Dia	Ø178.00	54.40	13.00	R78.00	R25.60	R6.50	9.50	12.30

REEL	Reel Size	Box	Box Size(mm)	Carton	Carton Size(mm)	G.W.(kg)
3000 pcs	7 inch	30,000 pcs	203×203×195	120,000 pcs	438×438×220	