

Sound Processor with Built-in 2-band Equalizer

BD37513FS

General Description

BD37513FS is a sound processor with built-in 2-band equalizer for car audio. The functions are 4ch stereo input selector, input-gain control, main volume, loudness, and 4ch fader volume. Moreover, its "Advanced switch circuit", which is an original ROHM technology, can reduce various switching noise (ex. No-signal, low frequency like 20Hz & large signal inputs). "Advanced switch" makes control of microcomputer easier, supporting the construction of a high quality car audio system.

Features

- Reduce switching noise of input gain control, mute, main volume, fader volume, bass, treble, loudness by using advanced switch circuit.
- Built-in 1 differential input selector and 3 single-ended input selectors
- Built-in ground isolation amplifier inputs, ideal for external stereo input.
- Built-in input gain controller reduces switching noise for volume of a portable audio input.
- Decrease the number of external components due to built-in 2-band equalizer filter and loudness filter. Also, it is possible to control Gv using I²C BUS control.
- It is possible to adjust the gain of the bass and treble up to ±20dB with 1 dB step gain adjustment.
- Energy-saving design resulting in low current consumption, by utilizing the Bi-CMOS process. It has the advantage in quality over scaling down the power heat control of the internal regulators.
- Input terminals and output terminals are organized and separately laid out to keep the signal flow in one direction which results in simpler and smaller PCB layout.
- It is possible to control the I²C BUS by 3.3V/5V.

Key Specifications

- Power Supply Voltage Range: 7.0V to 9.5V
- Circuit Current (No Signal): 38mA(Typ)
- Total Harmonic Distortion 1: 0.001%(Typ)
- Maximum Input Voltage: 2.3Vrms(Typ)
- Cross-talk Between Selectors: -100dB(Typ)
- Volume Control Range: +15dB to -79dB
- Output Noise Voltage 1: 3.8μVrms(Typ)
- Residual Output Noise Voltage: 1.8μVrms(Typ)
- Operating Temperature Range: -40°C to +85°C

Package

W(Typ) x D(Typ) x H(Max)



Applications

It is optimal for use in car audio systems. It can also be used for audio equipment of mini Compo, micro Compo, TV, etc.

Typical Application Circuit

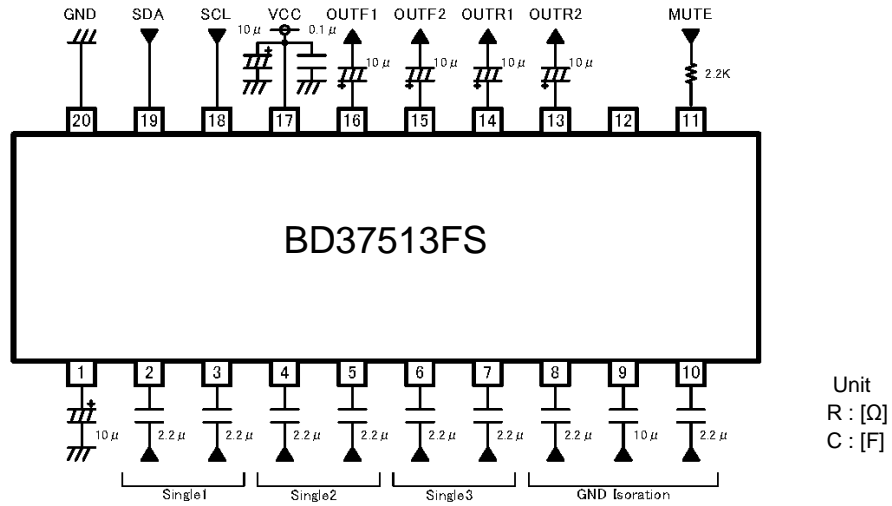

Unit
R : [Ω]
C : [F]

Pin Configuration

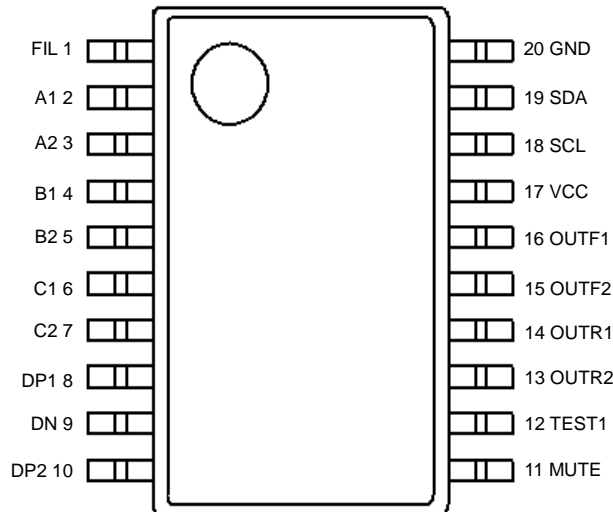

Pin Descriptions

Pin No.	Pin Name	Description	Pin No.	Pin Name	Description
1	FIL	VCC/2 terminal	11	MUTE	External compulsory mute terminal
2	A1	A input terminal of 1ch	12	TEST1	Test Pin
3	A2	A input terminal of 2ch	13	OUTR2	Rear output terminal of 2ch
4	B1	B input terminal of 1ch	14	OUTR1	Rear output terminal of 1ch
5	B2	B input terminal of 2ch	15	OUTF2	Front output terminal of 2ch
6	C1	C input terminal of 1ch	16	OUTF1	Front output terminal of 1ch
7	C2	C input terminal of 2ch	17	VCC	Power supply terminal
8	DP1	D positive input terminal of 1ch	18	SCL	I ² C Communication clock terminal
9	DN	D negative input terminal	19	SDA	I ² C Communication data terminal
10	DP2	D positive input terminal of 2ch	20	GND	GND terminal

Block Diagram

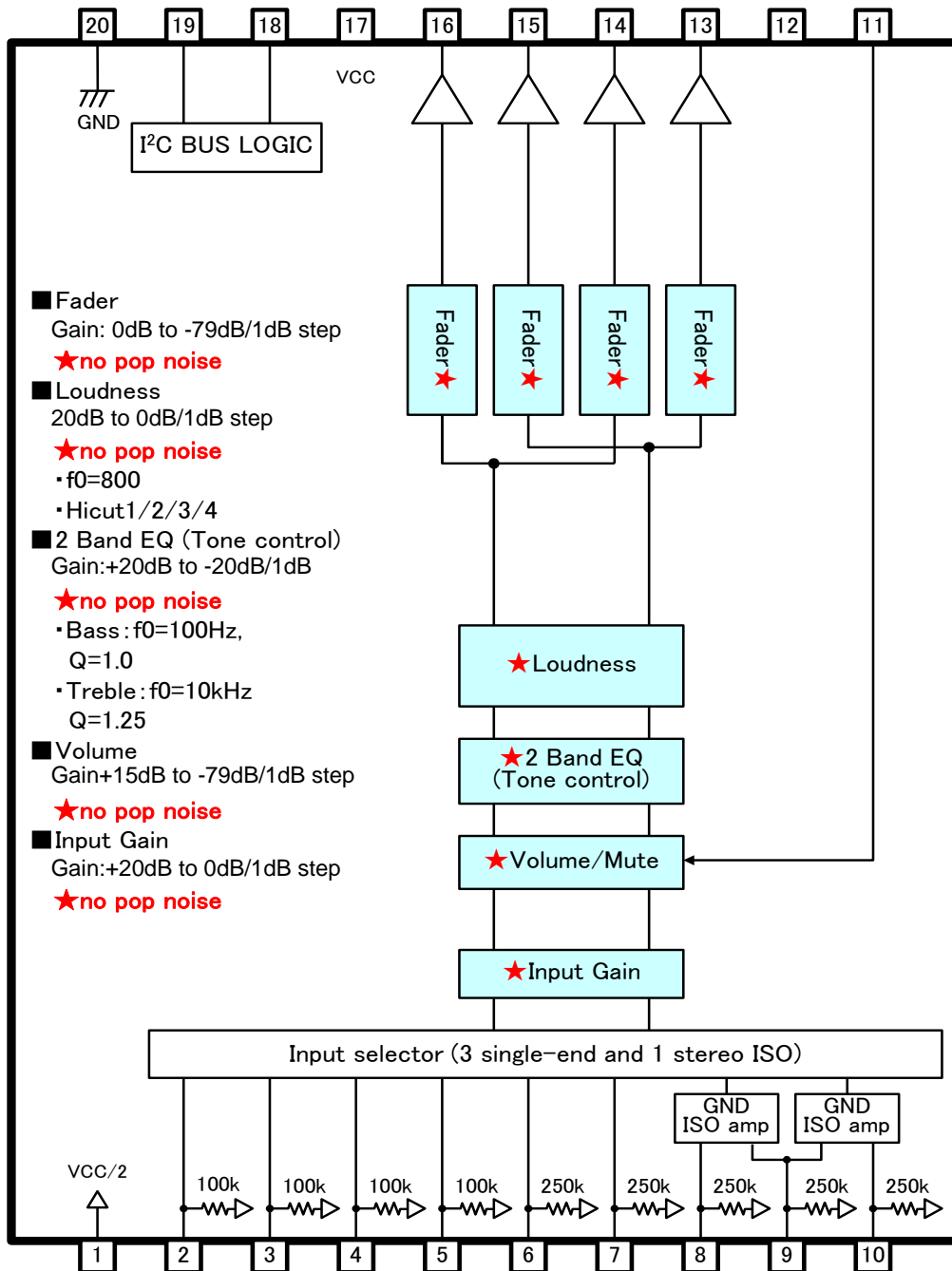

Absolute Maximum Ratings (Ta=25°C)

Parameter	Symbol	Rating	Unit
Power Supply Voltage	V _{CC}	10.0	V
Input Voltage	V _{IN}	V _{CC} +0.3 to GND-0.3	V
Power Dissipation	P _d	0.94 (Note)	W
Storage Temperature	T _{stg}	-55 to +150	°C

(Note) This value derates by 7.5mW/°C for Ta=25°C or more when ROHM standard board is used.

Thermal resistance θ_{ja} = 133.3(°C/W)

ROHM Standard board

Size : 70 x 70 x 1.6(mm³)

Material : A FR4 glass epoxy board(3% or less of copper foil area)

Caution: Operating the IC over the absolute maximum ratings may damage the IC. The damage can either be a short circuit between pins or an open circuit between pins and the internal circuitry. Therefore, it is important to consider circuit protection measures, such as adding a fuse, in case the IC is operated over the absolute maximum ratings.

Recommended Operating Conditions

Parameter	Symbol	Min	Typ	Max	Unit
Power Supply Voltage	V _{CC}	7.0	-	9.5	V
Temperature	Topr	-40	-	+85	V

Electrical Characteristics

(Unless specified otherwise, Ta=25°C, V_{CC}=8.5V, f=1kHz, V_{IN}=1Vrms, R_g=600Ω, R_L=10kΩ, A input, Input gain 0dB, Mute OFF, Volume 0dB, Tone control 0dB, Loudness 0dB, Fader 0dB)

BLOCK	Parameter	Symbol	Limit			Unit	Conditions
			Min	Typ	Max		
GENERAL	Circuit Current	I _Q	-	38	48	mA	No signal
	Voltage Gain	G _V	-1.5	0	+1.5	dB	G _V =20log(V _{OUT} /V _{IN})
	Channel Balance	CB	-1.5	0	+1.5	dB	CB = G _{V1} -G _{V2}
	Total Harmonic Distortion 1 (FRONT,REAR)	THD+N1	-	0.001	0.05	%	V _{OUT} =1Vrms BW=400HZ-30KHZ
	Output Noise Voltage 1 (FRONT,REAR) *	V _{NO1}	-	3.8	15	μVrms	R _g = 0Ω BW = IHF-A
	Residual Output Noise Voltage *	V _{NOR}	-	1.8	10	μVrms	Fader = -∞dB R _g = 0Ω BW = IHF-A
	Cross-talk Between Channels *	CTC	-	-100	-90	dB	R _g = 0Ω CTC=20log(V _{OUT} /V _{IN}) BW = IHF-A
INPUT SELECTOR	Ripple Rejection	RR	-	-70	-40	dB	f=1kHz V _{RR} =100mVrms RR=20log(V _{CC} IN/V _{OUT})
	Input Impedance(A,B)	R _{IN_S}	70	100	130	kΩ	
	Input Impedance (C,D)	R _{IN_D}	175	250	325	kΩ	
	Maximum Input Voltage	V _{IM}	2.1	2.3	-	Vrms	V _{IM} at THD+N(V _{OUT})=1% BW=400Hz-30KHZ
	Cross-talk Between Selectors *	CTS	-	-100	-90	dB	R _g = 0Ω CTS=20log(V _{OUT} /V _{IN}) BW = IHF-A
INPUT GAIN	Common Mode Rejection Ratio *	CMRR	50	65	-	dB	DP1 and DN input DP2 and DN input CMRR=20log(V _{IN} /V _{OUT}) BW = IHF-A
	Minimum Input Gain	G _{IN_MIN}	-2	0	+2	dB	Input gain 0dB V _{IN} =100mVrms G _{IN} =20log(V _{OUT} /V _{IN})
	Maximum Input Gain	G _{IN_MAX}	+18	+20	+22	dB	Input gain 20dB V _{IN} =100mVrms G _{IN} =20log(V _{OUT} /V _{IN})
	Gain Set Error	G _{IN_ERR}	-2	0	+2	dB	GAIN=+1dB to +20dB

Electrical Characteristics - continued

(Unless specified otherwise, Ta=25°C, VCC=8.5V, f=1kHz, VIN=1Vrms, Rg=600Ω, RL=10kΩ, A input, Input gain 0dB, Mute OFF, Volume 0dB, Tone control 0dB, Loudness 0dB, Fader 0dB)

BLOCK	Parameter	Symbol	Limit			Unit	Conditions
			Min	Typ	Max		
MUTE	Mute Attenuation *	GMUTE	-	-105	-85	dB	Mute ON GMUTE=20log(VOUT/VIN) BW = IHF-A
VOLUME	Maximum Gain	GV_MAX	+13	+15	+17	dB	Volume = 15dB VIN=100mVrms GV=20log(VOUT/VIN)
	Maximum Attenuation *	GV_MIN	-	-100	-85	dB	Volume = -∞dB GV=20log(VOUT/VIN) BW = IHF-A
	Attenuation Set Error 1	GV_ERR1	-2	0	+2	dB	GAIN & ATT=+15dB to -15dB
	Attenuation Set Error 2	GV_ERR2	-3	0	+3	dB	ATT=-16dB to -47dB
	Attenuation Set Error 3	GV_ERR3	-4	0	+4	dB	ATT=-48dB to -79dB
BASS	Maximum Boost Gain	GB_BST	+18	+20	+22	dB	Gain=+20dB f=100Hz VIN=100mVrms GB=20log(VOUT/VIN)
	Maximum Cut Gain	GB_CUT	-22	-20	-18	dB	Gain=-20dB f=100Hz VIN=2Vrms GB=20log(VOUT/VIN)
	Gain Set Error	GB_ERR	-2	0	+2	dB	Gain=+20dB to -20dB f=100Hz
TREBLE	Maximum Boost Gain	GT_BST	+18	+20	+22	dB	Gain=+20dB f=10kHz VIN=100mVrms GT=20log(VOUT/VIN)
	Maximum Cut Gain	GT_CUT	-23	-20	-17	dB	Gain=-20dB f=10kHz VIN=2Vrms GT=20log(VOUT/VIN)
	Gain Set Error	GT_ERR	-2	0	+2	dB	Gain=+20dB to -20dB f=10kHz
FADER / SUBWOOFER	Maximum Attenuation*	GF_MIN	-	-100	-90	dB	Fader = -∞dB GF=20log(VOUT/VIN) BW = IHF-A
	Attenuation Set Error 1	GF_ERR1	-2	0	+2	dB	ATT=0dB to -15dB
	Attenuation Set Error 2	GF_ERR2	-3	0	+3	dB	ATT=-16dB to -47dB
	Attenuation Set Error 3	GF_ERR3	-4	0	+4	dB	ATT=-48dB to -79dB
	Output Impedance	ROUT	-	-	50	Ω	VIN=100mVrms
	Maximum Output Voltage	VOM	2	2.2	-	Vrms	THD+N=1% BW=400Hz-30KHz
LOUDNESS	Maximum Gain	GL_MAX	+17	+20	+23	dB	Gain 20dB VIN=100mVrms GL=20log(VOUT/VIN)
	Gain Set Error	GL_ERR	-2	0	+2	dB	GAIN=+20dB to +1dB

VP-9690A (Average value detection, effective value display) filter by Matsushita Communication is used for * measurement.
Phase between input / output is same.

Typical Performance Curves

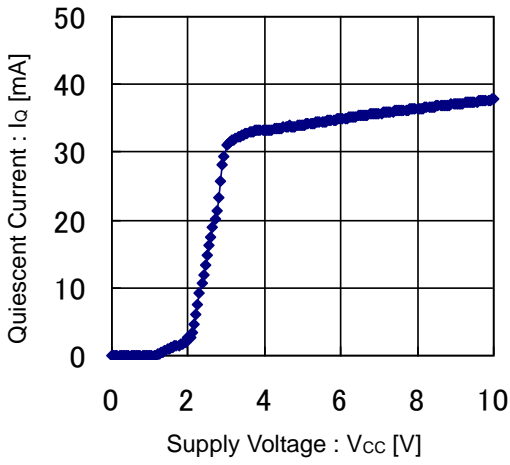

Figure 1. Quiescent Current vs Supply Voltage

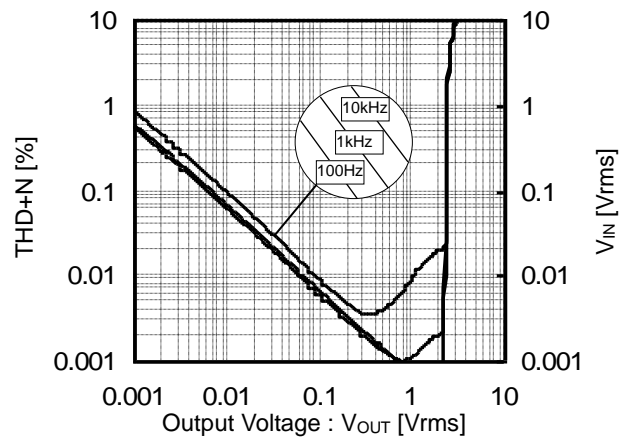

Figure 2. Total Harmonic Distortion vs Output Voltage

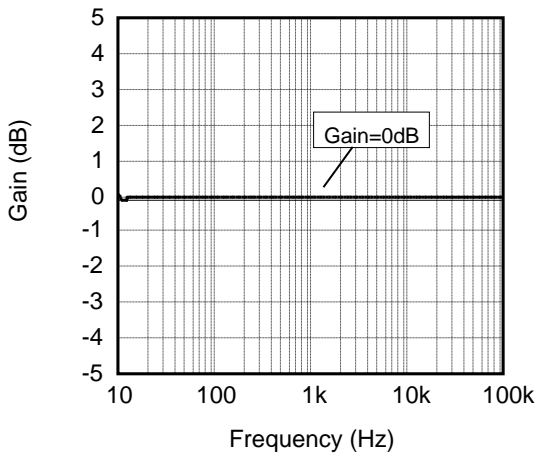

Figure 3. Gain vs Frequency

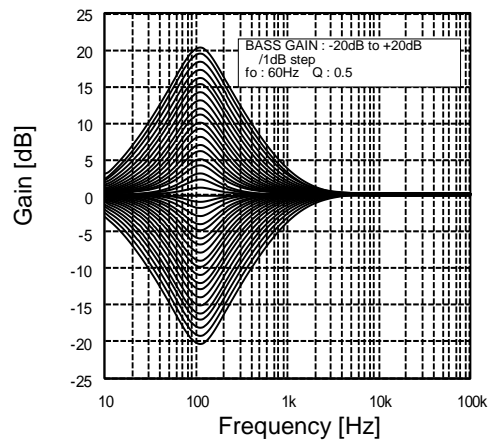

Figure 4. Bass Gain vs Frequency

Typical Performance Curves - continued

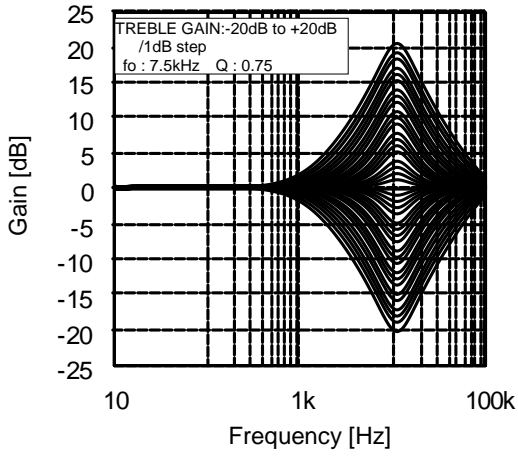

Figure 5 . Treble Gain vs Frequency

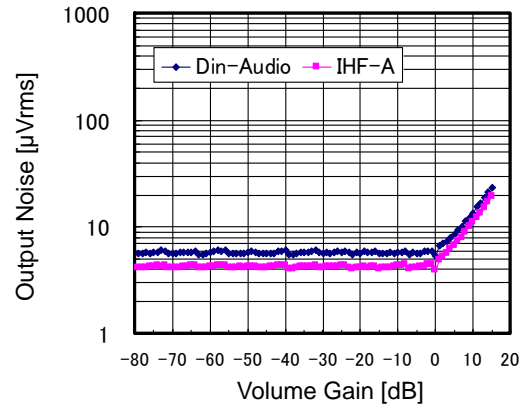

Figure 6. Output Noise vs Volume Gain

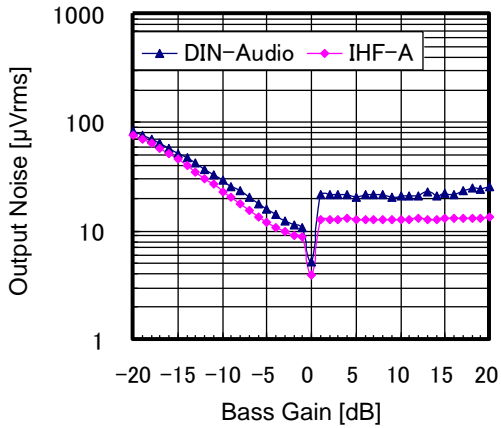

Figure 7. Output Noise vs Bass Gain

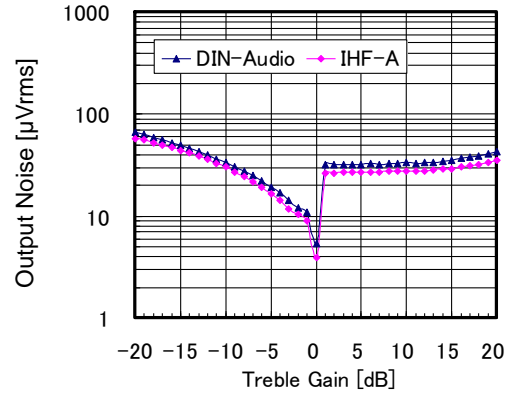

Figure 8. Output Noise vs Treble Gain

Typical Performance Curves - continued

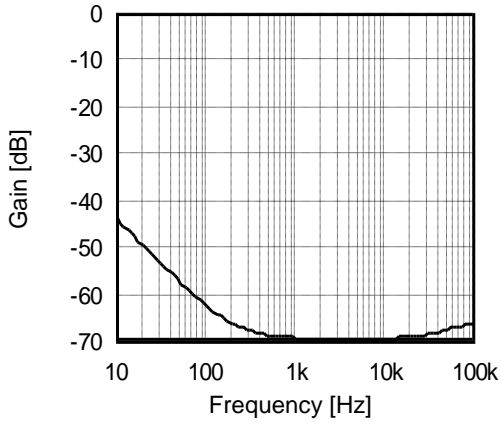

Figure 9. CMRR vs Frequency

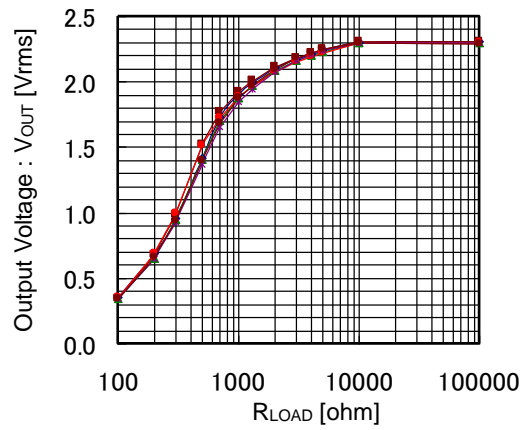

Figure 10. Output Voltage vs R_LOAD

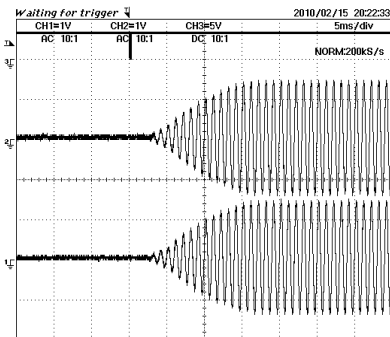

Figure 11. Advanced Switch 1

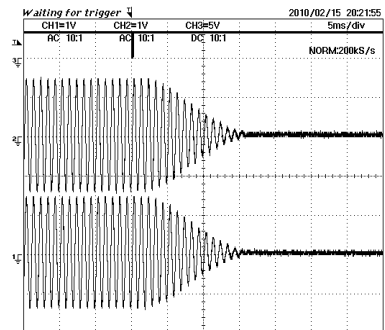

Figure 12. Advanced Switch 2

Timing Chart

Control Signal Specification

(1) Electrical Specifications and Timing for bus Lines and I/O Stage

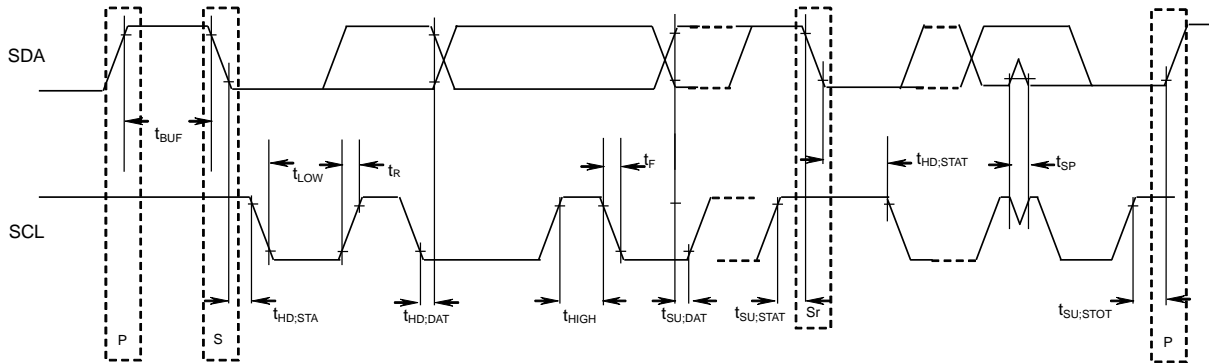

Figure 13. I²C-bus Signal Timing Diagram

Table 1 Characteristics of the SDA and SCL bus lines for I²C-bus devices

Parameter	Symbol	Fast-mode I²C-bus		Unit
		Min	Max	
1 SCL clock frequency	f _{SCL}	0	400	kHz
2 Bus free time between a STOP and START condition	t _{BUF}	1.3	-	µS
3 Hold time (repeated) START condition. After this period, the first clock pulse is generated	t _{HD:STA}	0.6	-	µS
4 LOW period of the SCL clock	t _{LOW}	1.3	-	µS
5 HIGH period of the SCL clock	t _{HIGH}	0.6	-	µS
6 Set-up time for a repeated START condition	t _{SU:STA}	0.6	-	µS
7 Data hold time:	t _{HD:DAT}	0.06 ^(Note)	-	µS
8 Data set-up time	t _{SU:DAT}	120	-	ns
9 Set-up time for STOP condition	t _{SU:STO}	0.6	-	µS

All values referred to VIH Min and VIL Max Levels (see Table 2).

(Note) To avoid sending right after the fall-edge of SCL (VIH min of the SCL signal), the transmitting device should set a hold time of 300ns or more for the SDA signal.
For 7(t_{HD:DAT}), 8(t_{SU:DAT}), make the setup in which the margin is fully in.

Table 2 Characteristics of the SDA and SCL I/O stages for I²C-bus devices

Parameter	Symbol	Fast-mode devices		Unit
		Min	Max	
10 LOW level input voltage:	V _{IL}	-0.3	+1	V
11 HIGH level input voltage:	V _{IH}	2.3	5	V
12 Pulse width of spikes which must be suppressed by the input filter.	t _{SP}	0	50	ns
13 LOW level output voltage: at 3mA sink current	V _{OL1}	0	0.4	V
14 Input current of each I/O pin with an input voltage between 0.4V and 4.5V.	I _i	-10	+10	µA

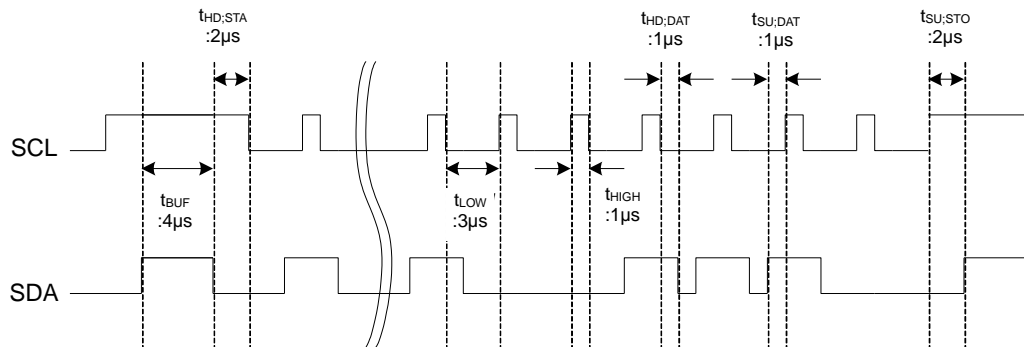

SCL clock frequency : 250kHz

Figure 14. I²C Data Transmission Command Timing Diagram

(2) I²C BUS FORMAT

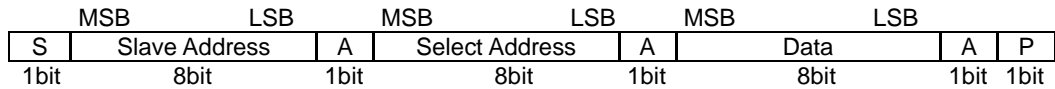

- S = Start condition (Recognition of start bit)
- Slave Address = Recognition of slave address. The first 7 bits correspond to the slave address. The least significant bit is "L" which corresponds to write mode.
- A = ACKNOWLEDGE bit (Recognition of acknowledgement)
- Select Address = Select address corresponding to volume, bass or treble.
- Data = Data on every volume and tone.
- P = Stop condition (Recognition of stop bit)

(3) I²C BUS Interface Protocol

(a) Basic Format

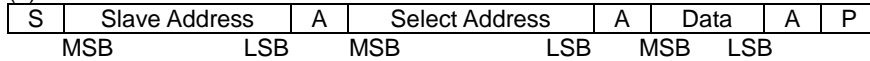

(b) Automatic Increment (Select Address increases (+1) according to the number of data.)

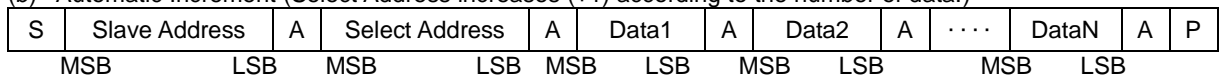

- (Example)
- ① Data1 shall be set as data of address specified by Select Address.
 - ② Data2 shall be set as data of address specified by Select Address +1.
 - ③ DataN shall be set as data of address specified by Select Address +N-1.

(c) Configuration Unavailable for Transmission (In this case, only Select Address1 is set.)

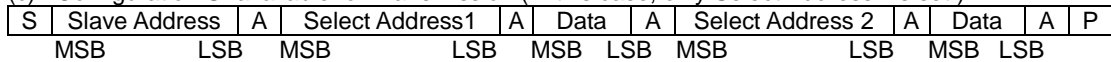

(Note)If any data is transmitted as Select Address 2 next to data, it is recognized as data, not as Select Address 2.

(4) Slave Address

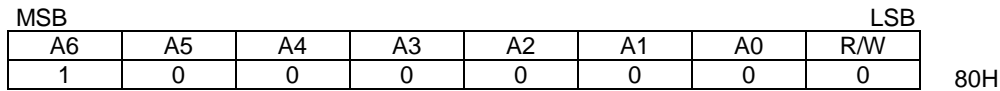

(5) Select Address & Data

Items	Select Address (hex)	MSB		Data				LSB	
		D7	D6	D5	D4	D3	D2	D1	D0
Initial setup 1	01	Advanced switch ON/OFF	0	Advanced switch time of Input Gain/Volume Tone/Fader/Loudness		0	0	Advanced switch time of Mute	
Initial setup 2	02	0	0	0	0	0	0	0	0
Initial setup 3	03	0	0	0	1	0	0	0	1
Input Selector	05	0	0	0	Input selector				
Input gain	06	Mute ON/OFF	0	0	Input Gain				
Volume gain	20	Volume Gain / Attenuation							
Fader 1ch Front	28	Fader Attenuation							
Fader 2ch Front	29	Fader Attenuation							
Fader 1ch Rear	2A	Fader Attenuation							
Fader 2ch Rear	2B	Fader Attenuation							
Test mode 1	2C	1	1	1	1	1	1	1	1
Test mode 2	41	0	0	1	0	0	0	0	1
Test mode 3	44	0	0	0	0	0	0	0	0
Test mode 4	47	0	0	0	1	0	0	0	1
Bass gain	51	Bass Boost/Cut	0	0	Bass Gain				
Test mode 5	54	1	0	0	0	0	0	0	0
Treble gain	57	Treble Boost/Cut	0	0	Treble Gain				
Loudness Gain	75	0	Loudness Hicut	Loudness Gain					
System Reset	FE	1	0	0	0	0	0	0	1

 Advanced switch

Note

1. The Advanced Switch works in the latch part while changing from one function to another.
2. Upon continuous data transfer, the Select Address rolls over because of the automatic increment function, as shown below.

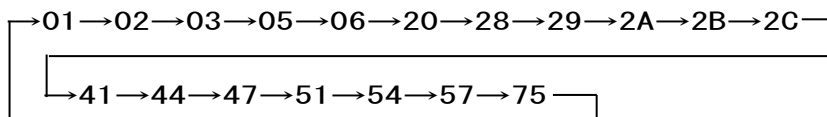

3. For the function of Input Selector etc, Advanced Switch is not used. Therefore, please apply mute on the set side when changing these settings.
4. When using mute function of this IC at the time of changing input selector, please switch mute ON/OFF while waiting for advanced-mute time.

Select address 01 (hex)

Time	Advanced switch time of Mute							LSB	
	D7	D6	D5	D4	D3	D2	D1	D0	
0.6msec	Advanced Switch ON/OFF	0	Advanced switch time of Input gain/Volume Tone/Fader/Loudness		0	0	0	0	
1.0msec							0	1	
1.4msec							1	0	
3.2msec							1	1	

Time	Advanced switch time of Input gain/Volume/Tone/Fader/Loudness							LSB	
	D7	D6	D5	D4	D3	D2	D1	D0	
4.7 msec	Advanced Switch ON/OFF	0	0	0	0	0	Advanced switch Time of Mute		
7.1 msec			0	1					
11.2 msec			1	0					
14.4 msec			1	1					

Mode	Advanced switch ON/OFF							LSB	
	D7	D6	D5	D4	D3	D2	D1	D0	
OFF	0	0	Advanced switch time of Input gain/Volume Tone/Fader/Loudness		0	0	Advanced switch Time of Mute		
ON	1								

Select address 05(hex)

Mode	Input Selector							LSB	
	D7	D6	D5	D4	D3	D2	D1	D0	
Initial	0	0	0	0	0	0	0	0	
A					0	0	0	1	
B					0	0	1	0	
C					0	0	1	1	
D diff					0	1	1	1	
Input SHORT					1	0	0	1	
Prohibition					Other setting				

Input SHORT : The input impedance of each input terminal is lowered from 100kΩ(TYP) to 6 kΩ(TYP).
(For quick charge of coupling capacitor)

 : Initial condition

Select address 06 (hex)

Gain	MSB			Input Gain				LSB
	D7	D6	D5	D4	D3	D2	D1	D0
0dB	0	0	0	0	0	0	0	0
1dB	0	0	0	0	0	0	0	1
2dB	0	0	0	0	0	0	1	0
3dB	0	0	0	0	0	0	1	1
4dB	0	0	0	0	0	1	0	0
5dB	0	0	0	0	0	1	0	1
6dB	0	0	0	0	0	1	1	0
7dB	0	0	0	0	0	1	1	1
8dB	0	0	0	0	1	0	0	0
9dB	0	0	0	0	1	0	0	1
10dB	0	0	0	0	1	0	1	0
11dB	0	0	0	0	1	0	1	1
12dB	0	0	0	0	1	1	0	0
13dB	0	0	0	0	1	1	0	1
14dB	0	0	0	0	1	1	1	0
15dB	0	0	0	0	1	1	1	1
16dB	1	0	0	0	0	0	0	0
17dB	1	0	0	0	0	0	0	1
18dB	1	0	0	0	0	0	1	0
19dB	1	0	0	0	0	0	1	1
20dB	1	0	0	0	0	1	0	0
Prohibition	:	:	:	:	:	:	:	:
	1	1	1	1	1	1	1	1

Mode	MSB			Mute ON/OFF				LSB
	D7	D6	D5	D4	D3	D2	D1	D0
OFF	0	0	0	Input Gain				
ON	1	0	0	Input Gain				

Select address 20, 28, 29, 2A, 2B (hex)

Gain & ATT	MSB			Vol. Fader Gain / Attenuation				LSB
	D7	D6	D5	D4	D3	D2	D1	D0
Prohibition	0	0	0	0	0	0	0	0
	0	0	0	0	0	0	0	1
	:	:	:	:	:	:	:	:
	0	1	1	1	0	0	0	0
15dB	0	1	1	1	0	0	0	1
14dB	0	1	1	1	0	0	1	0
13dB	0	1	1	1	0	0	1	1
:	:	:	:	:	:	:	:	:
-77dB	1	1	0	0	1	1	0	1
-78dB	1	1	0	0	1	1	1	0
-79dB	1	1	0	0	1	1	1	1
Prohibition	1	1	0	1	0	0	0	0
	:	:	:	:	:	:	:	:
	1	1	1	1	1	1	1	0
-∞dB	1	1	1	1	1	1	1	1

(Only 0dB to -∞dB are available at address 28, 29, 2A, 2B.)

: Initial condition

Select address 51, 57 (hex)

Gain	MSB			Bass/ Treble Gain				LSB	
	D7	D6	D5	D4	D3	D2	D1	D0	
0dB	Bass/ Treble Boost /cut	0	0	0	0	0	0	0	
1dB				0	0	0	0	1	
2dB				0	0	0	1	0	
3dB				0	0	0	1	1	
4dB				0	0	1	0	0	
5dB				0	0	1	0	1	
6dB				0	0	1	1	0	
7dB				0	0	1	1	1	
8dB				0	1	0	0	0	
9dB				0	1	0	0	1	
10dB				0	1	0	1	0	
11dB				0	1	0	1	1	
12dB				0	1	1	0	0	
13dB				0	1	1	0	1	
14dB				0	1	1	1	0	
15dB				0	1	1	1	1	
16dB				1	0	0	0	0	
17dB				1	0	0	0	1	
18dB				1	0	0	1	0	
19dB				1	0	0	1	1	
20dB	1	0	1	0	0				
Prohibition	1	0	1	0	1				
	:	:	:	:	:				
	1	1	1	1	0				
	1	1	1	1	1				

Mode	MSB			Bass/ Treble Boost/Cut				LSB	
	D7	D6	D5	D4	D3	D2	D1	D0	
Boost	0	0	0	Bass/Treble Gain					
Cut	1								

 : Initial condition

Select address 75 (hex)

Mode	MSB			Loudness Hicut				LSB	
	D7	D6	D5	D4	D3	D2	D1	D0	
Hicut1	0	0	0	Loudness Gain					
Hicut2		0	1						
Hicut3		1	0						
Hicut4		1	1						

Gain	MSB			Loudness Gain				LSB	
	D7	D6	D5	D4	D3	D2	D1	D0	
0dB	0	Loudness Hicut		0	0	0	0	0	
1dB				0	0	0	0	1	
2dB				0	0	0	1	0	
3dB				0	0	0	1	1	
4dB				0	0	1	0	0	
5dB				0	0	1	0	1	
6dB				0	0	1	1	0	
7dB				0	0	1	1	1	
8dB				0	1	0	0	0	
9dB				0	1	0	0	1	
10dB				0	1	0	1	0	
11dB				0	1	0	1	1	
12dB				0	1	1	0	0	
13dB				0	1	1	0	1	
14dB				0	1	1	1	0	
15dB				0	1	1	1	1	
16dB				1	0	0	0	0	
17dB				1	0	0	0	1	
18dB				1	0	0	1	0	
19dB				1	0	0	1	1	
20dB	1	0	1	0	0				
Prohibition				:	:	:	:	:	
				1	1	1	1	1	

 : Initial condition

(6) About Power ON Reset

Built-in IC initialization is made during power on of the supply voltage. Please send initial data to all addresses at supply voltage on. And please turn on mute at the set side until this initial data is sent.

Parameter	Symbol	Limit			Unit	Conditions
		Min	Typ	Max		
Rise Time of VCC	t _{RISE}	33	-	-	μsec	V _{CC} rise time from 0V to 5V
VCC Voltage of Release Power ON Reset	V _{POR}	-	4.1	-	V	

(7) About External Compulsory Mute Terminal

It is possible to force mute externally by setting an input voltage to the MUTE terminal.

Mute Voltage Condition	Mode
GND to 1.0V	MUTE ON
2.3V to V _{CC}	MUTE OFF

Establish the voltage of MUTE in the condition to be defined.

Application Information

1. Function and Specifications

Function	Specifications
Input selector	<ul style="list-style-type: none"> • Stereo 3 input • Differential 1 input
Input gain	<ul style="list-style-type: none"> • +20dB to 0dB (1dB step) • Possible to use "Advanced switch" for prevention of switching noise.
Mute	<ul style="list-style-type: none"> • Possible to use "Advanced switch" for prevention of switching noise.
Volume	<ul style="list-style-type: none"> • +15dB to -79dB (1dB step) , -∞dB • Possible to use "Advanced switch" for prevention of switching noise.
Bass	<ul style="list-style-type: none"> • +20dB to -20dB (1dB step) • Possible to use "Advanced switch" at changing gain • Q=1 • fo=100Hz
Treble	<ul style="list-style-type: none"> • +20dB to -20dB (1dB step) • Possible to use "Advanced switch" at changing gain • Q=1.25 • fo=10kHz
Fader	<ul style="list-style-type: none"> • 0dB to -79dB, -∞dB • Possible to use "Advanced switch" for prevention of switching noise.
Loudness	<ul style="list-style-type: none"> • 20dB to 0dB (1dB step) • fo=800Hz • Possible to use "Advanced switch" for prevention of switching noise.

2. Volume / Fader Volume Attenuation Data

(dB)	D7	D6	D5	D4	D3	D2	D1	D0	(dB)	D7	D6	D5	D4	D3	D2	D1	D0
+15	0	1	1	1	0	0	0	1	-33	1	0	1	0	0	0	0	1
+14	0	1	1	1	0	0	1	0	-34	1	0	1	0	0	0	1	0
+13	0	1	1	1	0	0	1	1	-35	1	0	1	0	0	0	1	1
+12	0	1	1	1	0	1	0	0	-36	1	0	1	0	0	1	0	0
+11	0	1	1	1	0	1	0	1	-37	1	0	1	0	0	1	0	1
+10	0	1	1	1	0	1	1	0	-38	1	0	1	0	0	1	1	0
+9	0	1	1	1	0	1	1	1	-39	1	0	1	0	0	1	1	1
+8	0	1	1	1	1	0	0	0	-40	1	0	1	0	1	0	0	0
+7	0	1	1	1	1	0	0	1	-41	1	0	1	0	1	0	0	1
+6	0	1	1	1	1	0	1	0	-42	1	0	1	0	1	0	1	0
+5	0	1	1	1	1	0	1	1	-43	1	0	1	0	1	0	1	1
+4	0	1	1	1	1	1	1	0	-44	1	0	1	0	1	1	0	0
+3	0	1	1	1	1	1	1	0	-45	1	0	1	0	1	1	0	1
+2	0	1	1	1	1	1	1	1	-46	1	0	1	0	1	1	1	0
+1	0	1	1	1	1	1	1	1	-47	1	0	1	0	1	1	1	1
0	1	0	0	0	0	0	0	0	-48	1	0	1	1	0	0	0	0
-1	1	0	0	0	0	0	0	1	-49	1	0	1	1	0	0	0	1
-2	1	0	0	0	0	0	1	0	-50	1	0	1	1	0	0	1	0
-3	1	0	0	0	0	0	1	1	-51	1	0	1	1	0	0	1	1
-4	1	0	0	0	0	1	0	0	-52	1	0	1	1	0	1	0	0
-5	1	0	0	0	0	1	0	1	-53	1	0	1	1	0	1	0	1
-6	1	0	0	0	0	1	1	0	-54	1	0	1	1	0	1	1	0
-7	1	0	0	0	0	1	1	1	-55	1	0	1	1	0	1	1	1
-8	1	0	0	0	1	0	0	0	-56	1	0	1	1	1	0	0	0
-9	1	0	0	0	1	0	0	1	-57	1	0	1	1	1	0	0	1
-10	1	0	0	0	1	0	1	0	-58	1	0	1	1	1	0	1	0
-11	1	0	0	0	1	0	1	1	-59	1	0	1	1	1	0	1	1
-12	1	0	0	0	1	1	0	0	-60	1	0	1	1	1	1	0	0
-13	1	0	0	0	1	1	0	1	-61	1	0	1	1	1	1	0	1
-14	1	0	0	0	1	1	1	0	-62	1	0	1	1	1	1	1	0
-15	1	0	0	0	1	1	1	1	-63	1	0	1	1	1	1	1	1
-16	1	0	0	1	0	0	0	0	-64	1	1	0	0	0	0	0	0
-17	1	0	0	1	0	0	0	1	-65	1	1	0	0	0	0	0	1
-18	1	0	0	1	0	0	1	0	-66	1	1	0	0	0	0	1	0
-19	1	0	0	1	0	0	1	1	-67	1	1	0	0	0	0	1	1
-20	1	0	0	1	0	1	0	0	-68	1	1	0	0	0	1	0	0
-21	1	0	0	1	0	1	0	1	-69	1	1	0	0	0	1	0	1
-22	1	0	0	1	0	1	1	0	-70	1	1	0	0	0	1	1	0
-23	1	0	0	1	0	1	1	1	-71	1	1	0	0	0	1	1	1
-24	1	0	0	1	1	0	0	0	-72	1	1	0	0	1	0	0	0
-25	1	0	0	1	1	0	0	1	-73	1	1	0	0	1	0	0	1
-26	1	0	0	1	1	0	1	0	-74	1	1	0	0	1	0	1	0
-27	1	0	0	1	1	0	1	1	-75	1	1	0	0	1	0	1	1
-28	1	0	0	1	1	1	0	0	-76	1	1	0	0	1	1	0	0
-29	1	0	0	1	1	1	0	1	-77	1	1	0	0	1	1	0	1
-30	1	0	0	1	1	1	1	0	-78	1	1	0	0	1	1	1	0
-31	1	0	0	1	1	1	1	1	-79	1	1	0	0	1	1	1	1
-32	1	0	1	0	0	0	0	0	-∞	1	1	1	1	1	1	1	1

For Fader Volume, only 0dB to -∞dB are available.

 : Initial condition

3. Application Circuit

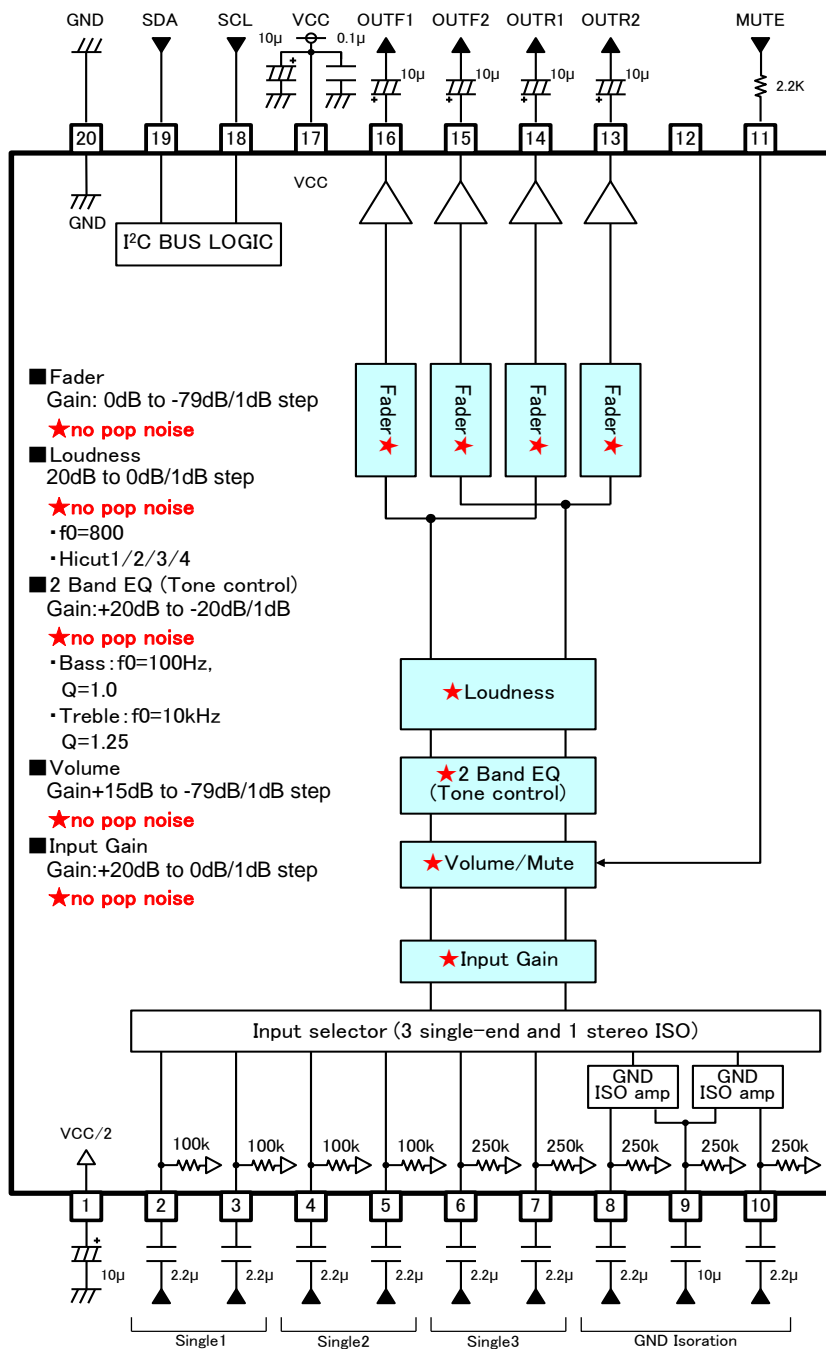

- Fader
Gain: 0dB to -79dB/1dB step
★no pop noise
- Loudness
20dB to 0dB/1dB step
★no pop noise
• f0=800
• Hicut1/2/3/4
- 2 Band EQ (Tone control)
Gain: +20dB to -20dB/1dB
★no pop noise
• Bass: f0=100Hz, Q=1.0
• Treble: f0=10kHz, Q=1.25
- Volume
Gain: +15dB to -79dB/1dB step
★no pop noise
- Input Gain
Gain: +20dB to 0dB/1dB step
★no pop noise

Unit
R : [Ω]
C : [F]

Notes on Wiring

- ① Please connect the decoupling capacitor of the power supply in the shortest possible distance to GND.
- ② GND lines should be one-point connected.
- ③ Wiring pattern of Digital should be away from that of Analog unit and cross-talk should not be acceptable.
- ④ SCL and SDA lines of I²C BUS should not be parallel if possible.
The lines should be shielded, if they are adjacent to each other.
- ⑤ Analog input lines should not be parallel if possible. The lines should be shielded, if they are adjacent to each other.
- ⑥ About TEST pin (Pin 12), please leave it as OPEN.

Power Dissipation

About the thermal design of the IC

Characteristics of an IC have a great deal to do with the temperature at which it is used, and exceeding absolute maximum ratings may degrade and destroy the device. Careful consideration must be given to the heat of the IC from the two standpoints of immediate damage and long-term reliability of operation.

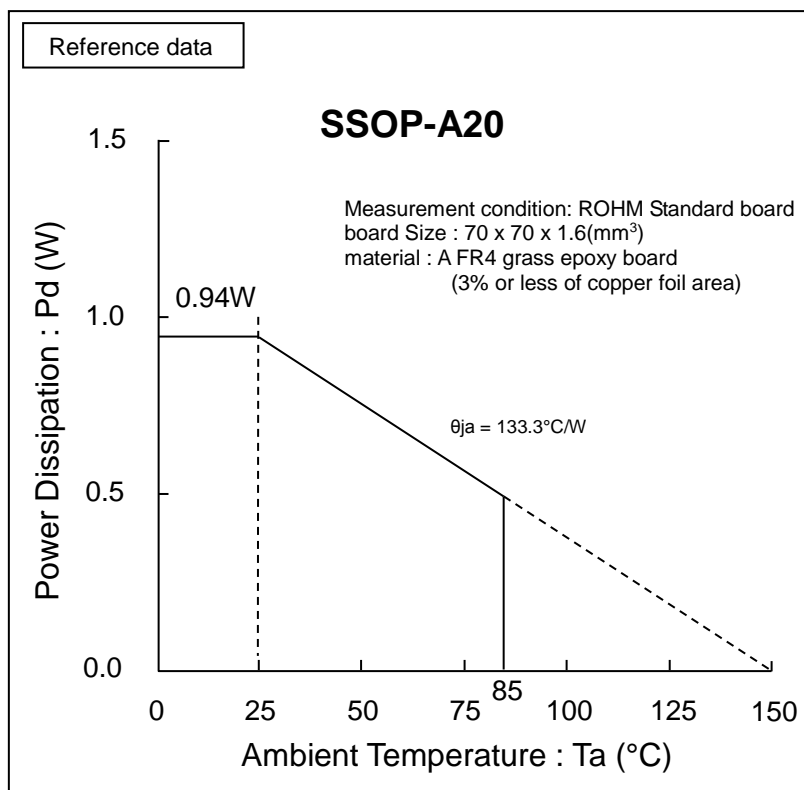

Figure 15. Temperature Derating Curve

(Note) Values are actual measurements and are not guaranteed.

Power dissipation values vary according to the board on which the IC is mounted

I/O Equivalent Circuits

Terminal No.	Terminal Name	Terminal voltage	Equivalent Circuit	Terminal Description
2 3 4 5	A1 A2 B1 B2	4.25		A terminal for signal input. The input impedance is 100kΩ(typ).
6 7	C1 C2	4.25		A terminal for signal input. The input impedance is 250kΩ(typ).
8 9 10	DP1 DN DP2	4.25		Input terminal available to Single/Differential mode. The input impedance is 250kΩ(typ).
11	MUTE	—		A terminal for external compulsory mute. If terminal voltage is High level, the mute is OFF. And if the terminal voltage is Low level, the mute is ON.
13 14 15 16	OUTR2 OUTR1 OUTF2 OUTF1	4.25		A terminal for fader and Subwoofer output.

Values in the pin explanation and input/output equivalent circuit are reference values only and are not guaranteed.

I/O Equivalent Circuit - continued

Terminal No.	Terminal Name	Terminal voltage	Equivalent Circuit	Terminal Description
17	VCC	8.5		Power supply terminal.
18	SCL	-		A terminal for clock input of I ² C BUS communication.
19	SDA	-		A terminal for data input of I ² C BUS communication.
20	GND	0		Ground terminal.
1	FIL	4.25		1/2 VCC terminal. Voltage for reference bias of analog signal system. The simple precharge circuit and simple discharge circuit for an external capacitor are built in.
12	TEST	-		TEST terminal

Values in the pin explanation and input/output equivalent circuit are reference values only and are not guaranteed.

Operational Notes

1. Reverse Connection of Power Supply

Connecting the power supply in reverse polarity can damage the IC. Take precautions against reverse polarity when connecting the power supply, such as mounting an external diode between the power supply and the IC's power supply pins.

2. Power Supply Lines

Design the PCB layout pattern to provide low impedance supply lines. Separate the ground and supply lines of the digital and analog blocks to prevent noise in the ground and supply lines of the digital block from affecting the analog block. Furthermore, connect a capacitor to ground at all power supply pins. Consider the effect of temperature and aging on the capacitance value when using electrolytic capacitors.

3. Ground Voltage

Ensure that no pins are at a voltage below that of the ground pin at any time, even during transient condition.

4. Ground Wiring Pattern

When using both small-signal and large-current ground traces, the two ground traces should be routed separately but connected to a single ground at the reference point of the application board to avoid fluctuations in the small-signal ground caused by large currents. Also ensure that the ground traces of external components do not cause variations on the ground voltage. The ground lines must be as short and thick as possible to reduce line impedance.

5. Thermal Consideration

Should by any chance the power dissipation rating be exceeded the rise in temperature of the chip may result in deterioration of the properties of the chip. In case of exceeding this absolute maximum rating, increase the board size and copper area to prevent exceeding the Pd rating.

6. Recommended Operating Conditions

These conditions represent a range within which the expected characteristics of the IC can be approximately obtained. The electrical characteristics are guaranteed under the conditions of each parameter.

7. Inrush Current

When power is first supplied to the IC, it is possible that the internal logic may be unstable and inrush current may flow instantaneously due to the internal powering sequence and delays, especially if the IC has more than one power supply. Therefore, give special consideration to power coupling capacitance, power wiring, width of ground wiring, and routing of connections.

8. Operation Under Strong Electromagnetic Field

Operating the IC in the presence of a strong electromagnetic field may cause the IC to malfunction.

9. Testing on Application Boards

When testing the IC on an application board, connecting a capacitor directly to a low-impedance output pin may subject the IC to stress. Always discharge capacitors completely after each process or step. The IC's power supply should always be turned off completely before connecting or removing it from the test setup during the inspection process. To prevent damage from static discharge, ground the IC during assembly and use similar precautions during transport and storage.

10. Inter-pin Short and Mounting Errors

Ensure that the direction and position are correct when mounting the IC on the PCB. Incorrect mounting may result in damaging the IC. Avoid nearby pins being shorted to each other especially to ground, power supply and output pin. Inter-pin shorts could be due to many reasons such as metal particles, water droplets (in very humid environment) and unintentional solder bridge deposited in between pins during assembly to name a few.

11. Unused Input Pins

Input pins of an IC are often connected to the gate of a MOS transistor. The gate has extremely high impedance and extremely low capacitance. If left unconnected, the electric field from the outside can easily charge it. The small charge acquired in this way is enough to produce a significant effect on the conduction through the transistor and cause unexpected operation of the IC. So unless otherwise specified, unused input pins should be connected to the power supply or ground line.

Operational Notes – continued

12. Regarding the Input Pin of the IC

This monolithic IC contains P+ isolation and P substrate layers between adjacent elements in order to keep them isolated. P-N junctions are formed at the intersection of the P layers with the N layers of other elements, creating a parasitic diode or transistor. For example (refer to figure below):

When GND > Pin A and GND > Pin B, the P-N junction operates as a parasitic diode.
 When GND > Pin B, the P-N junction operates as a parasitic transistor.

Parasitic diodes inevitably occur in the structure of the IC. The operation of parasitic diodes can result in mutual interference among circuits, operational faults, or physical damage. Therefore, conditions that cause these diodes to operate, such as applying a voltage lower than the GND voltage to an input pin (and thus to the P substrate) should be avoided.

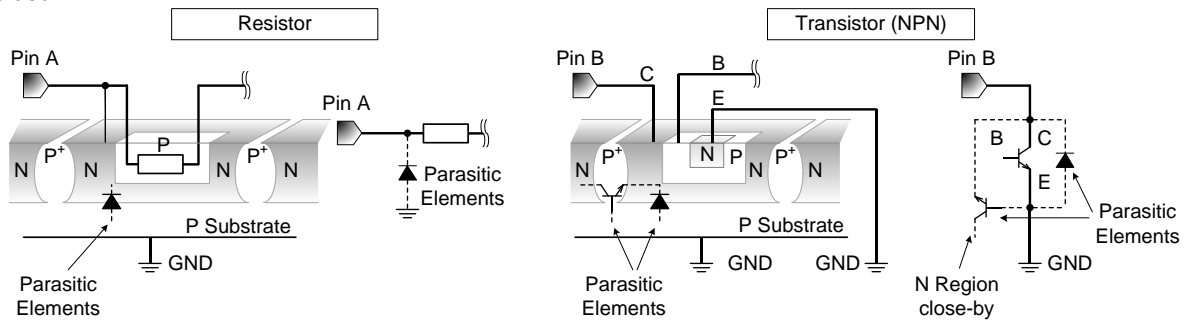
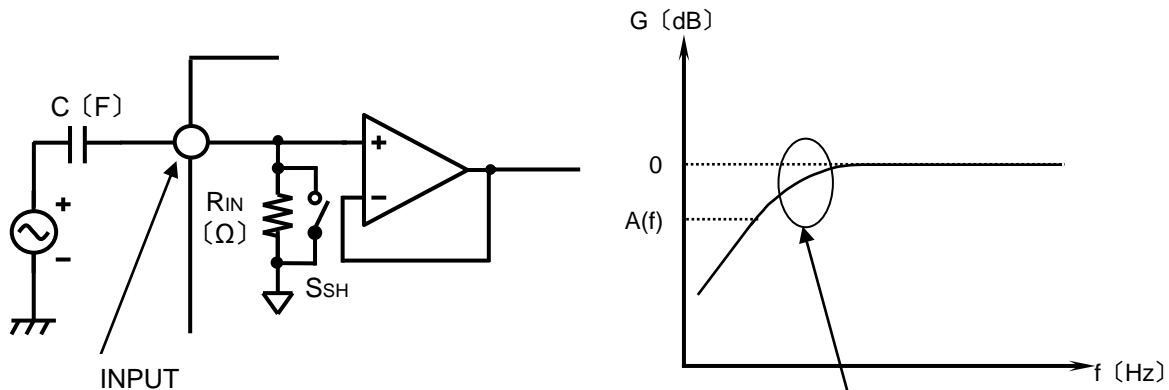

Figure 16. Example of monolithic IC structure

13. About a Signal Input Part

(a) About Input Coupling Capacitor Constant Value

In the input signal terminal, please decide the constant value of the input coupling capacitor C(F) that would be sufficient to form an RC characterized HPF with input impedance R_{IN}(Ω) inside the IC.



$$A(f) = \frac{(2\pi fCR_{IN})^2}{\sqrt{1 + (2\pi fCR_{IN})^2}}$$

(b) About the Input Selector SHORT

SHORT mode is the command which makes switch S_{SH} =ON of input selector part so that the input impedance R_{IN} of all terminals becomes small. Switch S_{SH} is OFF when SHORT command is not selected. The constant time brought about by the small resistance inside and the capacitor outside the LSI becomes small when this command is used. The charge time of the capacitor becomes short. Since SHORT mode turns ON the switch of S_{SH} and makes it low impedance, please use it at no signal condition.

14. About Mute Terminal(Pin 11) when power supply is OFF

There should be no applied voltage across the Mute terminal (Pin 11) when power-supply is OFF. A resistor (about 2.2kΩ) should be connected in series to Mute terminal in case a voltage is supplied to Mute terminal. (Please refer Application Circuit Diagram.)

15. About TEST Pin

TEST Pin, should be OPEN.
 Pin 12 are TEST Pins.

Ordering Information

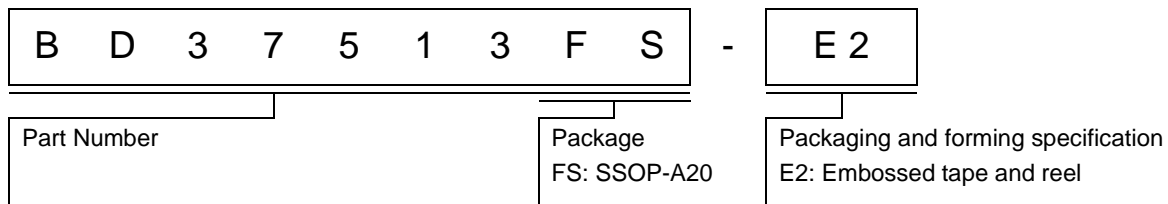

Marking Diagram

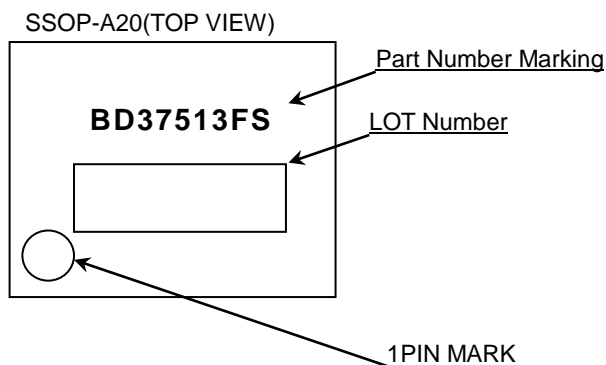

Physical Dimension, Tape and Reel Information

Package Name	SSOP-A20
--------------	----------

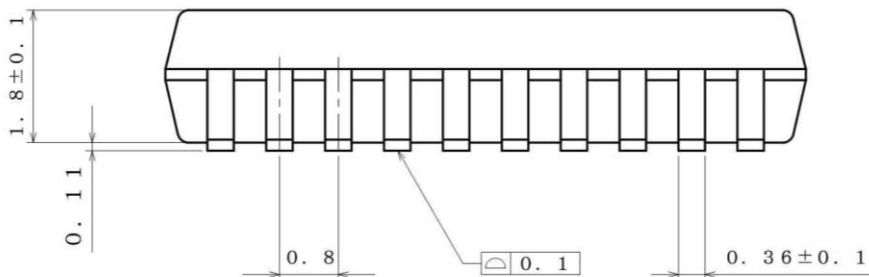
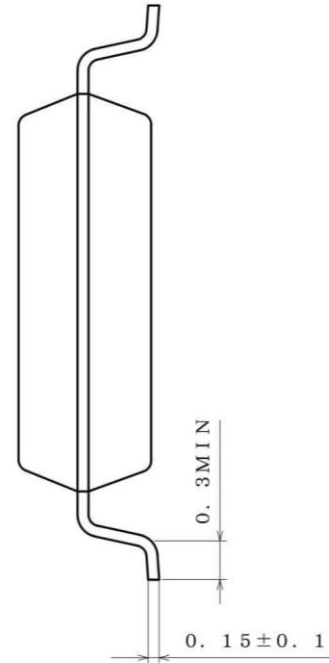
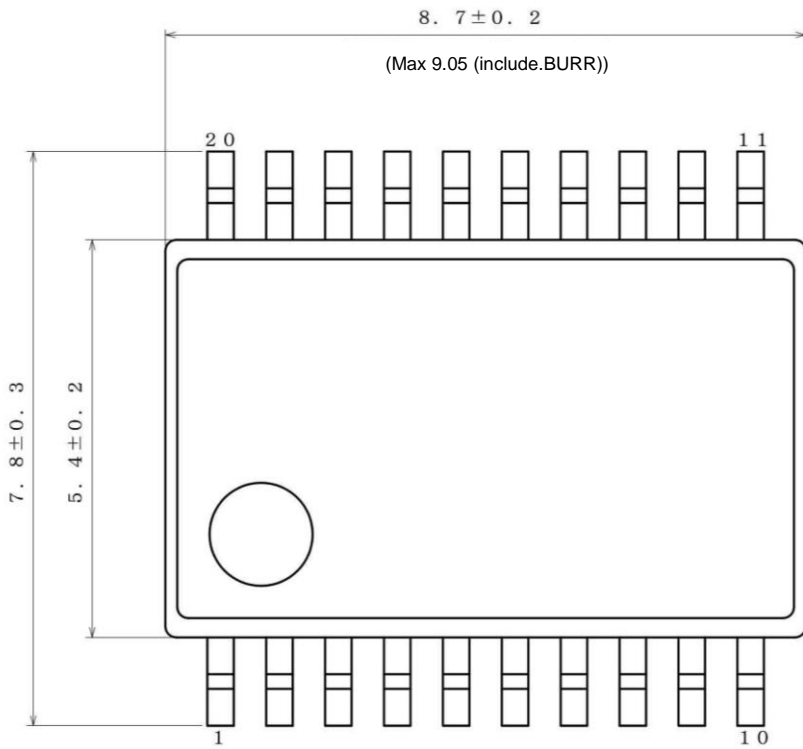

(UNIT : mm)
PKG : SSOP-A20
Drawing No. : EX132-5001

<Tape and Reel information>

Tape	Embossed carrier tape
Quantity	2000pcs
Direction of feed	E2 (The direction is the 1pin of product is at the upper left when you hold reel on the left hand and you pull out the tape on the right hand)

1pin
*Order quantity needs to be multiple of the minimum quantity.

Reel
Direction of feed

Revision History

Date	Revision	Changes
16.Dec.2015	001	New Release

Notice

Precaution on using ROHM Products

- Our Products are designed and manufactured for application in ordinary electronic equipments (such as AV equipment, OA equipment, telecommunication equipment, home electronic appliances, amusement equipment, etc.). If you intend to use our Products in devices requiring extremely high reliability (such as medical equipment ^(Note 1), transport equipment, traffic equipment, aircraft/spacecraft, nuclear power controllers, fuel controllers, car equipment including car accessories, safety devices, etc.) and whose malfunction or failure may cause loss of human life, bodily injury or serious damage to property ("Specific Applications"), please consult with the ROHM sales representative in advance. Unless otherwise agreed in writing by ROHM in advance, ROHM shall not be in any way responsible or liable for any damages, expenses or losses incurred by you or third parties arising from the use of any ROHM's Products for Specific Applications.

(Note1) Medical Equipment Classification of the Specific Applications

JAPAN	USA	EU	CHINA
CLASS III	CLASS III	CLASS II b	CLASS III
CLASS IV		CLASS III	

- ROHM designs and manufactures its Products subject to strict quality control system. However, semiconductor products can fail or malfunction at a certain rate. Please be sure to implement, at your own responsibilities, adequate safety measures including but not limited to fail-safe design against the physical injury, damage to any property, which a failure or malfunction of our Products may cause. The following are examples of safety measures:
 - Installation of protection circuits or other protective devices to improve system safety
 - Installation of redundant circuits to reduce the impact of single or multiple circuit failure
- Our Products are designed and manufactured for use under standard conditions and not under any special or extraordinary environments or conditions, as exemplified below. Accordingly, ROHM shall not be in any way responsible or liable for any damages, expenses or losses arising from the use of any ROHM's Products under any special or extraordinary environments or conditions. If you intend to use our Products under any special or extraordinary environments or conditions (as exemplified below), your independent verification and confirmation of product performance, reliability, etc. prior to use, must be necessary:
 - Use of our Products in any types of liquid, including water, oils, chemicals, and organic solvents
 - Use of our Products outdoors or in places where the Products are exposed to direct sunlight or dust
 - Use of our Products in places where the Products are exposed to sea wind or corrosive gases, including Cl₂, H₂S, NH₃, SO₂, and NO₂
 - Use of our Products in places where the Products are exposed to static electricity or electromagnetic waves
 - Use of our Products in proximity to heat-producing components, plastic cords, or other flammable items
 - Sealing or coating our Products with resin or other coating materials
 - Use of our Products without cleaning residue of flux (even if you use no-clean type fluxes, cleaning residue of flux is recommended); or Washing our Products by using water or water-soluble cleaning agents for cleaning residue after soldering
 - Use of the Products in places subject to dew condensation
- The Products are not subject to radiation-proof design.
- Please verify and confirm characteristics of the final or mounted products in using the Products.
- In particular, if a transient load (a large amount of load applied in a short period of time, such as pulse. is applied, confirmation of performance characteristics after on-board mounting is strongly recommended. Avoid applying power exceeding normal rated power; exceeding the power rating under steady-state loading condition may negatively affect product performance and reliability.
- De-rate Power Dissipation depending on ambient temperature. When used in sealed area, confirm that it is the use in the range that does not exceed the maximum junction temperature.
- Confirm that operation temperature is within the specified range described in the product specification.
- ROHM shall not be in any way responsible or liable for failure induced under deviant condition from what is defined in this document.

Precaution for Mounting / Circuit board design

- When a highly active halogenous (chlorine, bromine, etc.) flux is used, the residue of flux may negatively affect product performance and reliability.
- In principle, the reflow soldering method must be used on a surface-mount products, the flow soldering method must be used on a through hole mount products. If the flow soldering method is preferred on a surface-mount products, please consult with the ROHM representative in advance.

For details, please refer to ROHM Mounting specification

Precautions Regarding Application Examples and External Circuits

1. If change is made to the constant of an external circuit, please allow a sufficient margin considering variations of the characteristics of the Products and external components, including transient characteristics, as well as static characteristics.
2. You agree that application notes, reference designs, and associated data and information contained in this document are presented only as guidance for Products use. Therefore, in case you use such information, you are solely responsible for it and you must exercise your own independent verification and judgment in the use of such information contained in this document. ROHM shall not be in any way responsible or liable for any damages, expenses or losses incurred by you or third parties arising from the use of such information.

Precaution for Electrostatic

This Product is electrostatic sensitive product, which may be damaged due to electrostatic discharge. Please take proper caution in your manufacturing process and storage so that voltage exceeding the Products maximum rating will not be applied to Products. Please take special care under dry condition (e.g. Grounding of human body / equipment / solder iron, isolation from charged objects, setting of Ionizer, friction prevention and temperature / humidity control).

Precaution for Storage / Transportation

1. Product performance and soldered connections may deteriorate if the Products are stored in the places where:
 - [a] the Products are exposed to sea winds or corrosive gases, including Cl₂, H₂S, NH₃, SO₂, and NO₂
 - [b] the temperature or humidity exceeds those recommended by ROHM
 - [c] the Products are exposed to direct sunshine or condensation
 - [d] the Products are exposed to high Electrostatic
2. Even under ROHM recommended storage condition, solderability of products out of recommended storage time period may be degraded. It is strongly recommended to confirm solderability before using Products of which storage time is exceeding the recommended storage time period.
3. Store / transport cartons in the correct direction, which is indicated on a carton with a symbol. Otherwise bent leads may occur due to excessive stress applied when dropping of a carton.
4. Use Products within the specified time after opening a humidity barrier bag. Baking is required before using Products of which storage time is exceeding the recommended storage time period.

Precaution for Product Label

QR code printed on ROHM Products label is for ROHM's internal use only.

Precaution for Disposition

When disposing Products please dispose them properly using an authorized industry waste company.

Precaution for Foreign Exchange and Foreign Trade act

Since concerned goods might be fallen under listed items of export control prescribed by Foreign exchange and Foreign trade act, please consult with ROHM in case of export.

Precaution Regarding Intellectual Property Rights

1. All information and data including but not limited to application example contained in this document is for reference only. ROHM does not warrant that foregoing information or data will not infringe any intellectual property rights or any other rights of any third party regarding such information or data.
2. ROHM shall not have any obligations where the claims, actions or demands arising from the combination of the Products with other articles such as components, circuits, systems or external equipment (including software).
3. No license, expressly or implied, is granted hereby under any intellectual property rights or other rights of ROHM or any third parties with respect to the Products or the information contained in this document. Provided, however, that ROHM will not assert its intellectual property rights or other rights against you or your customers to the extent necessary to manufacture or sell products containing the Products, subject to the terms and conditions herein.

Other Precaution

1. This document may not be reprinted or reproduced, in whole or in part, without prior written consent of ROHM.
2. The Products may not be disassembled, converted, modified, reproduced or otherwise changed without prior written consent of ROHM.
3. In no event shall you use in any way whatsoever the Products and the related technical information contained in the Products or this document for any military purposes, including but not limited to, the development of mass-destruction weapons.
4. The proper names of companies or products described in this document are trademarks or registered trademarks of ROHM, its affiliated companies or third parties.

General Precaution

1. Before you use our Products, you are requested to carefully read this document and fully understand its contents. ROHM shall not be in any way responsible or liable for failure, malfunction or accident arising from the use of any ROHM's Products against warning, caution or note contained in this document.
2. All information contained in this document is current as of the issuing date and subject to change without any prior notice. Before purchasing or using ROHM's Products, please confirm the latest information with a ROHM sales representative.
3. The information contained in this document is provided on an "as is" basis and ROHM does not warrant that all information contained in this document is accurate and/or error-free. ROHM shall not be in any way responsible or liable for any damages, expenses or losses incurred by you or third parties resulting from inaccuracy or errors of or concerning such information.



BD37513FS - Web Page

[Distribution Inventory](#)

Part Number	BD37513FS
Package	SSOP-A20
Unit Quantity	2000
Minimum Package Quantity	2000
Packing Type	Taping
Constitution Materials List	inquiry
RoHS	Yes