

Features

- Non-isolation buck topology
- Integrated 500V MOSFET
- Wide AC input range – from 85V_{AC} to 265V_{AC}
- High Power Factor of >0.9 without additional circuitry
- Accurate constant current (< ±3%)
- Low start-up current reduces power dissipation
- Full protection functions for enhanced safety:
 - ♦ Gate driver output voltage clamp
 - ♦ VCC over voltage protection – VCC OVP
 - ♦ VCC under-voltage lockout with hysteresis – VCC UVLO
 - ♦ Output LED string over current protection
 - ♦ Output LED string short protection
 - ♦ Output LED string open protection
 - ♦ On-chip over temperature protection – OTP
- Package: 8-pin SOP

Applications

- General illumination
- E26/27, T5/T8 LED Lamps
- Other LED Lighting Applications

General Description

The HT7L4815 is a non-isolation buck PWM controller for LED lighting applications. The device has a fully integrated PFC circuit which operates in a boundary conduction mode (BCM) to achieve high power factor values. A high voltage power MOSFETs is integrated in the device. With full control provided over the internal MOSFETs, the device can easily meet the exacting LED current and high power factor requirements.

The device provides several protection functions, which include VCC Under Voltage Lockout (UVLO), Over Current Protection (OCP), Output LED String Open Protection, Output LED String Short Protection, VCC Over Voltage Protection (OVP) and Leading-Edge Blanking (LEB) for current sensing. Additionally and to ensure system reliability, the device includes a fully integrated thermal protection function.

The high level of functional integration minimises the external component count giving major advantages in terms of cost and circuit board area. The device is supplied in a 8-pin SOP package.

Block Diagram

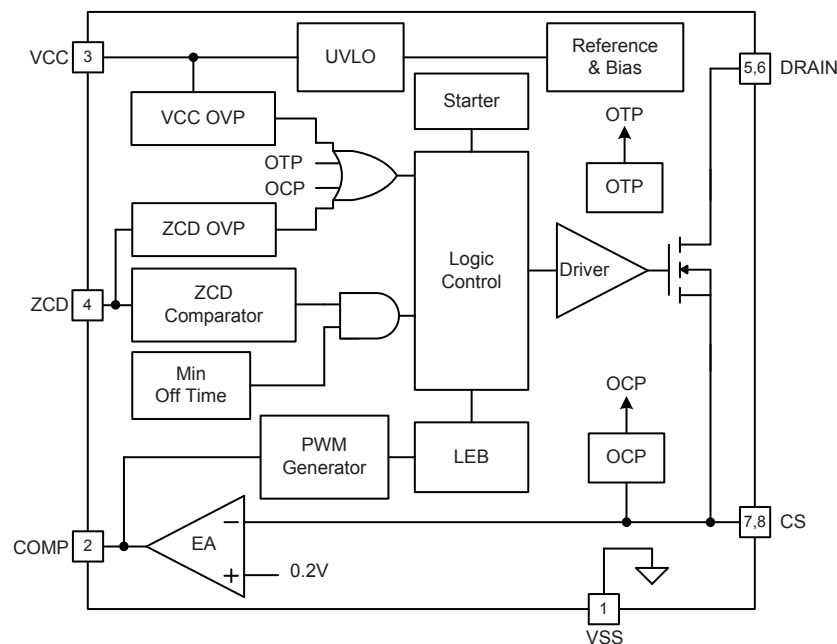

Pin Assignment

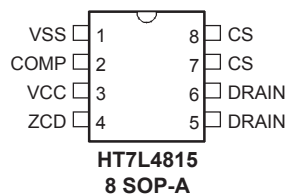

Pin Description

Pin No.	Symbol	Description
1	VSS	Ground pin.
2	COMP	Loop compensation pin. A capacitor is placed between COMP and GND.
3	VCC	Power supply pin.
4	ZCD	Zero-current detect pin.
5, 6	DRAIN	Internal high voltage power MOSFET drain terminals.
7, 8	CS	Current sense pin. A resistor is connected to sense the MOSFET current.

Absolute Maximum Ratings

Parameter	Range
Internal MOSFET drain source voltage	-0.3V to 500V
VCC supply voltage	-0.3V to 33V
CS pin Input voltage	-0.3V to 6V
COMP pin Output voltage	-0.3V to 6V
ZCD pin Maximum current	3mA (source), 3mA (sink)
Maximum operating junction temperature	150°C
Storage temperature range	-55°C to 150°C

Recommended Operating Ranges

Parameter	Range
VCC Supply voltage	17V~25V
Operating junction temperature	-40°C~125°C
Output power	18.3W@300mA, 90~264Vac 21W@300mA, 180~264Vac

Electrical Characteristics
 $V_{CC}=18V, T_a=25^{\circ}C$

Symbol	Parameter	Test Condition	Min	Typ	Max	Unit
Power Supply (VCC Pin)						
V _{CCON}	UVLO _{ON}	—	—	18	—	V
V _{CCOFF}	UVLO _{OFF}	—	—	10	—	V
V _{CCHYS}	UVLO Hysteresis	—	7	—	—	V
V _{OVP}	VCC OVP Trip Point	—	26	29	32	V
I _{START}	Start-up Current	Before turn-on, @ V _{CC} =UVLO _{ON} - 1V	—	10	20	μA
I _Q	Quiescent Current	No switching	—	0.6	1	mA
Error Amplifier						
V _{FB}	Feedback Reference Voltage	T _a =25°C	194	200	206	mV
Current Sense Comparator						
T _{LEB}	Leading Edge Blanking Time	—	—	400	—	ns
V _{CL}	Current Limit Threshold	—	—	1.1	—	V
V _{OCP}	Over Current Trip Point	—	—	0.9	—	V
	Over Current Release Point	—	—	0.2	—	V
Zero Current Detector						
V _{ZCDH}	Upper Clamp Voltage	I _{ZCD} =300μA	—	3	—	V
V _{ZCDL}	Lower Clamp Voltage	I _{ZCD} =-2.5mA	—	-0.2	—	V
V _{ZCDA}	Positive-Going Edge	—	—	1.5	—	V
V _{ZCDT}	Negative-Going Edge	—	—	1	—	V
I _{OVP}	OVP Current on ZCD pin	—	270	300	330	μA
T _{B_OVP}	Blanking Time for OVP Detection	—	—	1	—	μs
Starter						
T _{START}	Start Timer Period	—	—	40	—	μs
T _{OFF}	Minimum Off Time	—	—	4	—	μs
Over Temperature Protection						
OTP	Over Temperature Trip Point	—	—	150	—	°C
Power MOSFET						
R _{DS}	Power MOSFET Switch ON Resistance	@ V _{GS} =10V, I _{DS} =0.5A	—	2.5	—	Ω
BV _{DSS}	Power MOSFET Drain-Source Voltage	@ V _{GS} =0V, I _{DS} <250μA	500	—	—	V

Typical Performance Characteristics

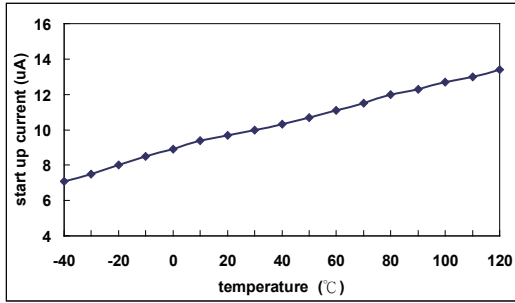

Figure 1. Start-Up current vs. temperature

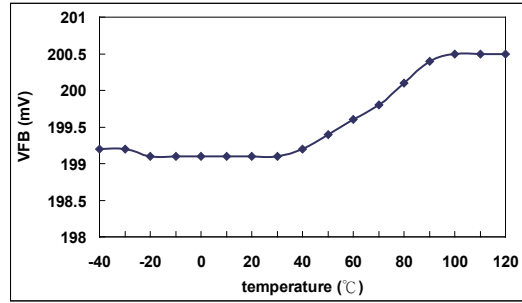

Figure 5. VFB vs. temperature

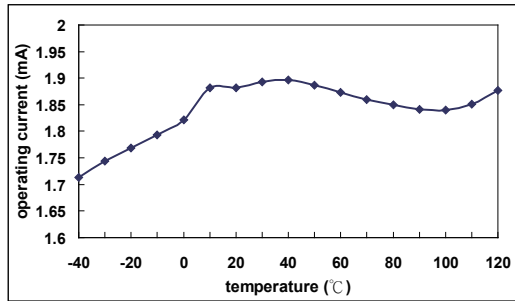

Figure 2. Operation current vs. temperature

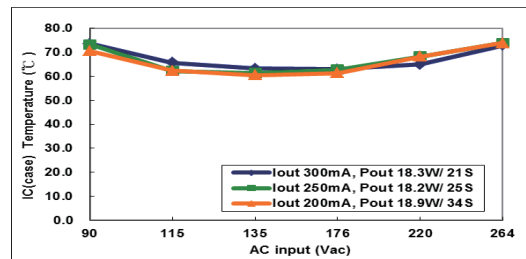

Figure 6. Temperature vs. Wide AC Voltage

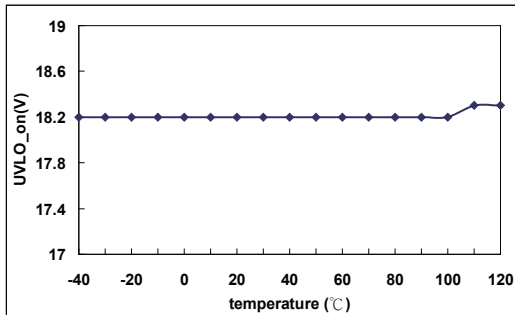

Figure 3. UVLO_on vs. temperature

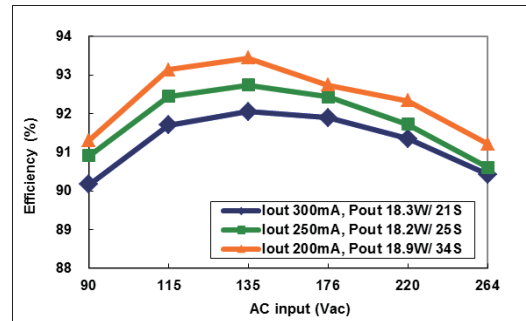

Figure 7. Efficiency vs. Wide AC Voltage

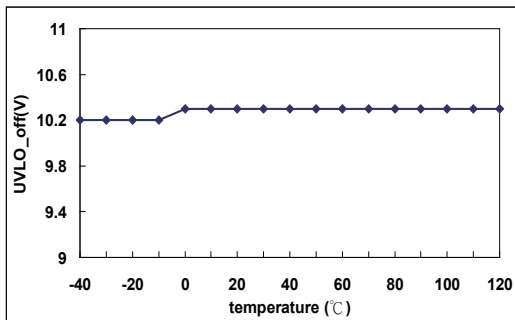

Figure 4. UVLO_off vs. temperature

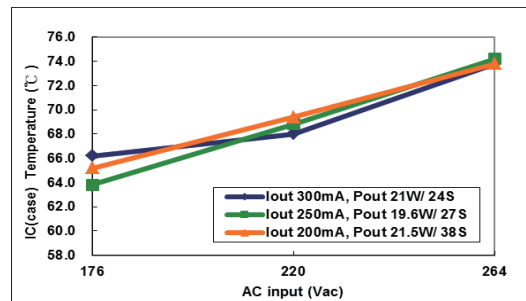

Figure 8. Temperature vs. High AC Voltage

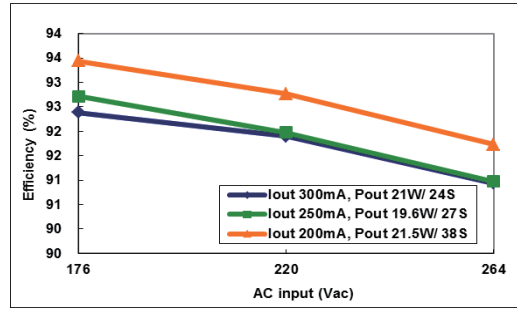
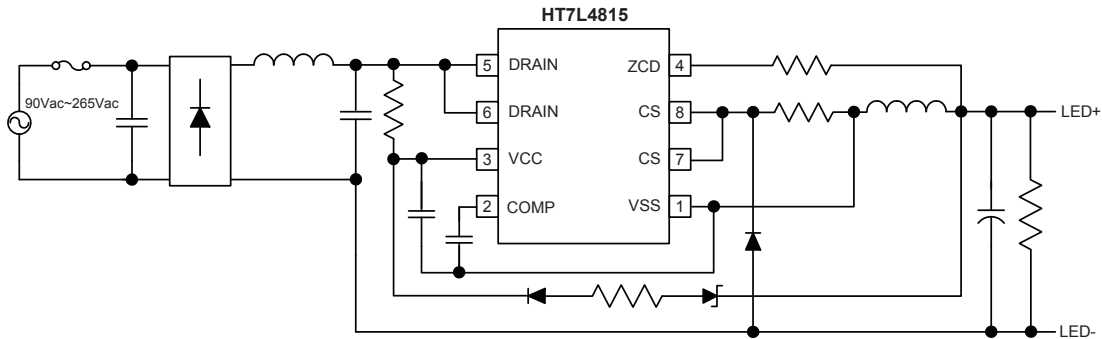

Figure 9. Efficiency vs. High AC Voltage

Typical Application Circuit



Functional Description

The HT7L4815 is a universal AC/DC LED driver designed for LED lighting applications. The device can achieve high Power Factor values without resorting to additional circuits and can also generate high accuracy LED drive currents with very few external components. Separate grounds are provided. One is a floating ground for the device while the other is the earth terminal. Users should be aware that the two grounds cannot be directly connected together to avoid IC damage and system malfunction.

Start-up Current

A very low start-up current, I_{START} , allows the users to select a larger value of start-up resistor which reduces power dissipation.

VCC Under Voltage Lockout – UVLO

The device includes a UVLO feature which has 8V hysteresis. The PWM controller turns on when VCC is higher than 18V and turns off when VCC is lower than 10V. The hysteresis characteristics guarantee that the device can be powered by an input capacitor during start-up. When the output voltage increases to a certain value after start-up, VCC will be charged by an output through an auxiliary winding or a Zener Diode. $V_Z = V_{LED} - V_{CC}$.

Boundary Conduction Mode – BCM

The power MOSFET is turned on by inductor current zero-crossing detection. The current zero-crossing can be detected by a ZCD voltage. When the inductor current is at the zero crossing point, the voltage on the ZCD pin will drop rapidly. The device then detects the falling edge and turns on the internal power MOSFET. The boundary conduction mode provides for low turn-on switching losses and high conversion efficiency.

Zero Current Detection – ZCD

The ZCD voltage is designed to operate between 0V and 3V for normal operation. If the voltage on the ZCD pin goes higher than 1.5V, the ZCD comparator waits until the voltage goes below 1V. When the inductor current is at the zero crossing point, the voltage on the ZCD pin will drop rapidly. The device will then detect the 1V falling edge and turn on the Power MOSFET. The 0.5V hysteresis avoids any false triggering actions due to noise.

Constant Current Control

The HT7L4815 will sense the overall inductor current and form a closed-loop with an internal error amplifier to obtain high constant current accuracy. The CS voltage and the 0.2V reference voltage form the inputs to an internal Gm amplifier whose output is integrated via an external COMP capacitor. The ON time of the MOSFET is controlled by the COMP voltage to adjust the output current.

LEB on CS – Leading-Edge Blanking

Each time the internal power MOSFET is switched on, a turn-on spike will inevitably occur at the sense resistor. To avoid faulty triggering, a 400ns leading-edge blank time is generated. As this function is provided conventional RC filtering is therefore unnecessary. During this blanking period, the current-limit comparator is disabled and can therefore not switch off the gate driver.

OVP on VCC – Over Voltage Protection

In order to prevent PWM controller damage, the device includes an OVP function on VCC. Should the VCC voltage be higher than the OVP threshold voltage of 29V, the PWM controller will stop operating immediately. When the VCC voltage decreases below the UVLO off level, the controller will reset.

LED Open Protection – ZCD OVP

The LED voltage is reflected on the ZCD pin through a resistor RZCD. When the current on the resistor RZCD is higher than 300μA, then ZCD OVP protection will take place. Here the PWM controller will stop operating immediately. When the VCC voltage decreases below the UVLO off level, the controller will reset.

$V_{OVP-ZCD}$ can be set using the following equation:

$$V_{OVP-ZCD} = V_{ZCDH} + I_{OVP} \times R_{ZCD}$$

V_{ZCDH} is the 3V upper clamp voltage on the ZCD pin. I_{OVP} represents the OVP current level on the ZCD pin which is 300μA. R_{ZCD} stands for the resistor connected between the ZCD pin and the LED positive terminal.

OCP – Over Current Protection

The device includes an over current protection function on the CS pin. An internal circuit detects the current level and when the current is larger than the over current protection threshold level, V_{OCP}/R_{CS} , the gate output will remain at a low level.

LED Short Protection – SCP

The output voltage drops when a number of LEDs in a string are shorted resulting in a voltage drop at VCC. Once the VCC drops below 10V, the device will stop operating. Under such situations, the start-up operation will recharge the VCC pin through the start-up resistor and the device will enter the UVLO hiccup mode.

Thermal Protection

A thermal protection feature is included to protect the device from excessive heat damage. When the junction temperature exceeds a threshold of 150°C, the thermal protection function will turn off the DRAIN terminal immediately. When the VCC decreases below the UVLO off level, the controller will reset.

Package Information

Note that the package information provided here is for consultation purposes only. As this information may be updated at regular intervals users are reminded to consult the [Holtek website](#) for the latest version of the [Package/ Carton Information](#).

Additional supplementary information with regard to packaging is listed below. Click on the relevant section to be transferred to the relevant website page.

- Package Information (include Outline Dimensions, Product Tape and Reel Specifications)
- The Operation Instruction of Packing Materials
- Carton information

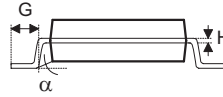
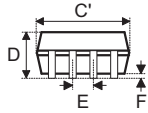
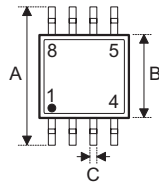
8-pin SOP (150mil) Outline Dimensions

Symbol	Dimensions in inch		
	Min.	Nom.	Max.
A	—	0.236 BSC	—
B	—	0.154 BSC	—
C	0.012	—	0.020
C'	—	0.193 BSC	—
D	—	—	0.069
E	—	0.050 BSC	—
F	0.004	—	0.010
G	0.016	—	0.050
H	0.004	—	0.010
α	0°	—	8°

Symbol	Dimensions in mm		
	Min.	Nom.	Max.
A	—	6.00 BSC	—
B	—	3.90 BSC	—
C	0.31	—	0.51
C'	—	4.90 BSC	—
D	—	—	1.75
E	—	1.27 BSC	—
F	0.10	—	0.25
G	0.40	—	1.27
H	0.10	—	0.25
α	0°	—	8°

Copyright© 2015 by HOLTEK SEMICONDUCTOR INC.

The information appearing in this Data Sheet is believed to be accurate at the time of publication. However, Holtek assumes no responsibility arising from the use of the specifications described. The applications mentioned herein are used solely for the purpose of illustration and Holtek makes no warranty or representation that such applications will be suitable without further modification, nor recommends the use of its products for application that may present a risk to human life due to malfunction or otherwise. Holtek's products are not authorized for use as critical components in life support devices or systems. Holtek reserves the right to alter its products without prior notification. For the most up-to-date information, please visit our web site at <http://www.holtek.com.tw>.