

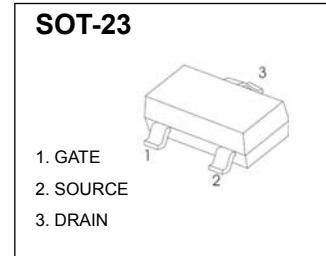

SOT-23 Plastic-Encapsulate MOSFETS

CJ3415 P-Channel 20-V(D-S) MOSFET

$V_{(BR)DSS}$	$R_{DS(on)MAX}$	I_D
-20V	50mΩ@-4.5V	-4A
	60mΩ@-2.5V	
	73mΩ@-1.8V	



FEATURE

- Excellent $R_{DS(ON)}$, low gate charge, low gate voltages

APPLICATION

- Load switch and in PWM applications

MARKING

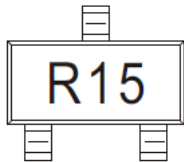

Equivalent Circuit

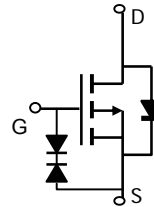

Maximum ratings ($T_a=25^\circ\text{C}$ unless otherwise noted)

Parameter	Symbol	Value	Unit
Drain-Source Voltage	V_{DS}	-20	V
Gate-Source Voltage	V_{GS}	± 8	
Continuous Drain Current ($t \leq 10s$)	I_D	-4.0	A
Maximum Power Dissipation ($t \leq 10s$)	P_D	0.35	W
Thermal Resistance from Junction to Ambient	$R_{\theta JA}$	357	$^\circ\text{C/W}$
Operating Junction Temperature	T_J	150	$^\circ\text{C}$
Storage Temperature	T_{STG}	-55 ~ +150	$^\circ\text{C}$

MOSFET ELECTRICAL CHARACTERISTICS

$T_a=25^\circ\text{C}$ unless otherwise specified

Parameter	Symbol	Test Condition	Min	Typ	Max	Units
Static Parameters						
Drain-source breakdown voltage	$V_{(BR)DSS}$	$V_{GS} = 0V, I_D = -250\mu A$	-20			V
Gate threshold voltage	$V_{GS(th)}$	$V_{DS} = V_{GS}, I_D = -250\mu A$	-0.3	-0.56	-1	
Gate-body leakage current	I_{GSS}	$V_{DS} = 0V, V_{GS} = \pm 8V$			± 10	μA
		$V_{DS} = 0V, V_{GS} = \pm 4.5V$			± 1	
Zero gate voltage drain current	I_{DSS}	$V_{DS} = -16V, V_{GS} = 0V$			-1	
Drain-source on-state resistance(note1)	$R_{DS(on)}$	$V_{GS} = -4.5V, I_D = -4A$		0.037	0.050	Ω
		$V_{GS} = -2.5V, I_D = -4A$		0.045	0.060	
		$V_{GS} = -1.8V, I_D = -2A$		0.056	0.073	
Forward transconductance(note2)	g_{FS}	$V_{DS} = -5V, I_D = -4A$	8			S
Body diode voltage(note2)	V_{SD}	$I_S = -1A, V_{GS} = 0V$			-1	V
Dynamic Parameters (note3)						
Input capacitance	C_{iss}	$V_{DS} = -10V, V_{GS} = 0V, f = 1MHz$		1450		μF
Output capacitance	C_{oss}			205		
Reverse transfer capacitance	C_{rss}			160		
Gate resistance	R_g	$V_{DS} = 0V, V_{GS} = 0V, f = 1MHz$		6.5		Ω
Switching Parameters						
Total gate charge	Q_g	$V_{DS} = -10V, V_{GS} = -4.5V, I_D = -4A$		17.2		nC
Gate-Source charge	Q_{gs}			1.3		
Gate-drain charge	Q_{gd}			4.5		
Turn-on delay time (note3)	$t_{d(on)}$	$V_{DS} = -10V, V_{GS} = -4.5V$ $R_{GEN} = 3\Omega, R_L = 2.5\Omega,$		9.5		ns
Turn-on rise time(note3)	t_r			17		
Turn-off delay time(note3)	$t_{d(off)}$			94		
Turn-off fall time(note3)	t_f			35		

Notes:

1. Repetitive rating, pulse width limited by junction temperature.
2. Pulse Test : Pulse width $\leq 300\mu s$, duty cycle $\leq 2\%$.
3. These parameters have no way to verify.

Typical Characteristics

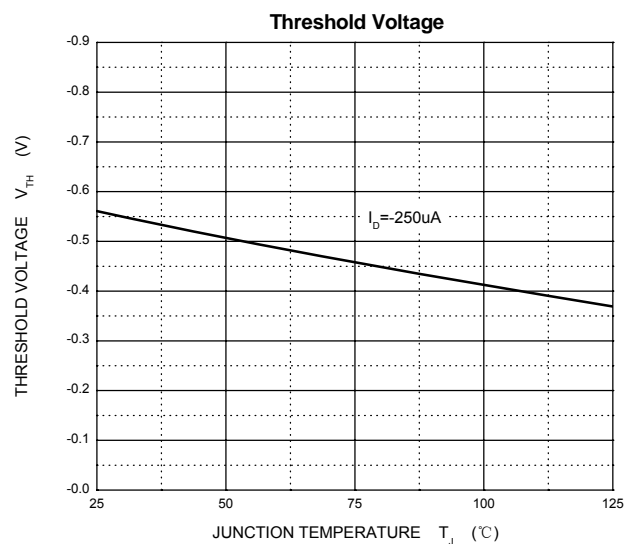
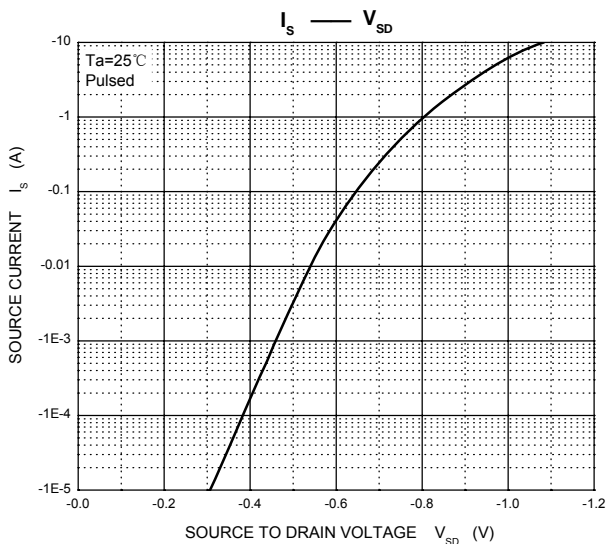
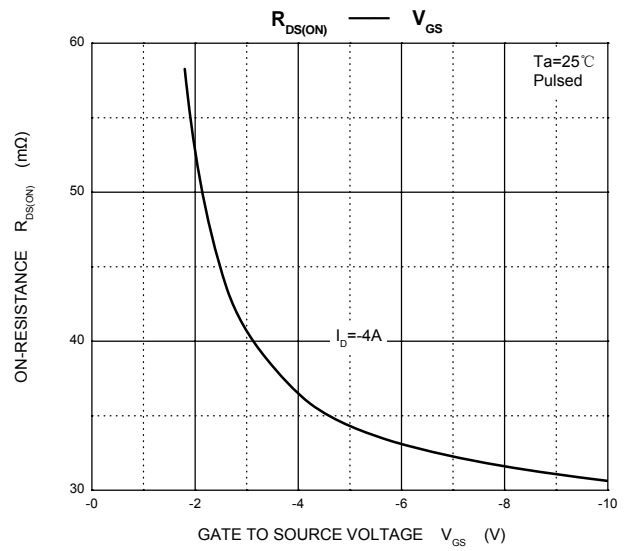
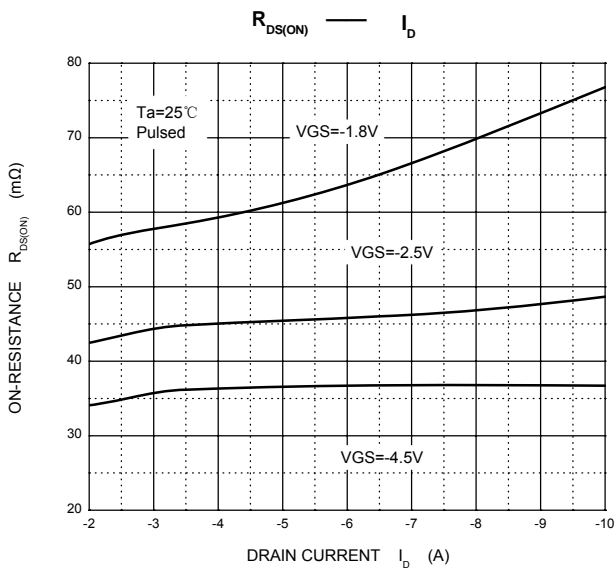
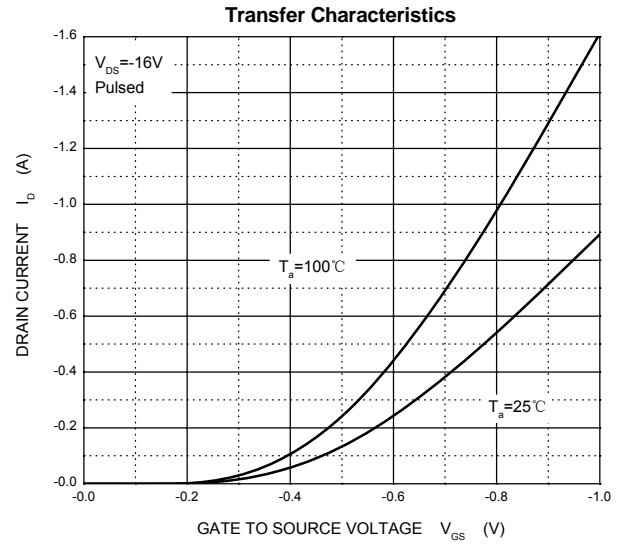
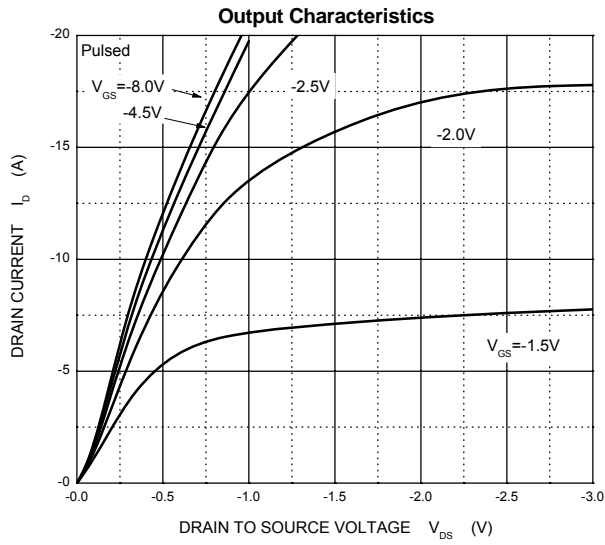

SOT-23 Package Outline Dimensions



Symbol	Dimensions In Millimeters		Dimensions In Inches	
	Min	Max	Min	Max
A	0.900	1.150	0.035	0.045
A1	0.000	0.100	0.000	0.004
A2	0.900	1.050	0.035	0.041
b	0.300	0.500	0.012	0.020
c	0.080	0.150	0.003	0.006
D	2.800	3.000	0.110	0.118
E	1.200	1.400	0.047	0.055
E1	2.250	2.550	0.089	0.100
e	0.950 TYP		0.037 TYP	
e1	1.800	2.000	0.071	0.079
L	0.550 REF		0.022 REF	
L1	0.300	0.500	0.012	0.020
θ	0°	8°	0°	8°

SOT-23 Suggested Pad Layout



Note:

1. Controlling dimension: in millimeters.
2. General tolerance: $\pm 0.05\text{mm}$.
3. The pad layout is for reference purposes only.

NOTICE

JCET reserve the right to make modifications, enhancements, improvements, corrections or other changes without further notice to any product herein. JCET does not assume any liability arising out of the application or use of any product described herein.

SOT-23 Tape and reel

SOT-23 Embossed Carrier Tape

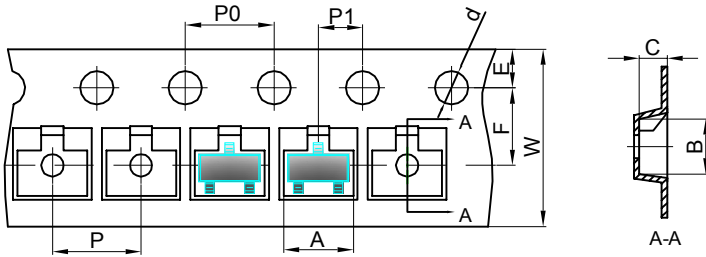

Packaging Description:

SOT-23 parts are shipped in tape. The carrier tape is made from a dissipative (carbon filled) polycarbonate resin. The cover tape is a multilayer film (Heat Activated Adhesive in nature) primarily composed of polyester film, adhesive layer, sealant, and anti-static sprayed agent. These reeled parts in standard option are shipped with 3,000 units per 7" or 17.8cm diameter reel. The reels are clear in color and is made of polystyrene plastic (anti-static coated).

Dimensions are in millimeter										
Pkg type	A	B	C	d	E	F	P0	P	P1	W
SOT-23	3.15	2.77	1.22	Ø1.50	1.75	3.50	4.00	4.00	2.00	8.00

SOT-23 Tape Leader and Trailer

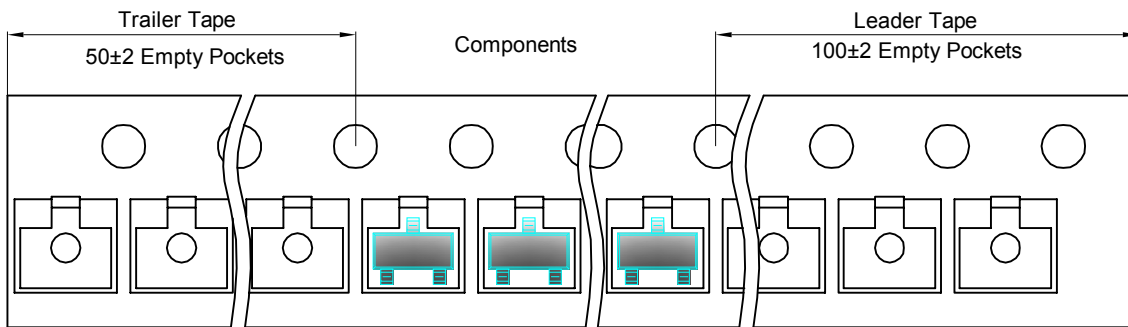

SOT-23 Reel

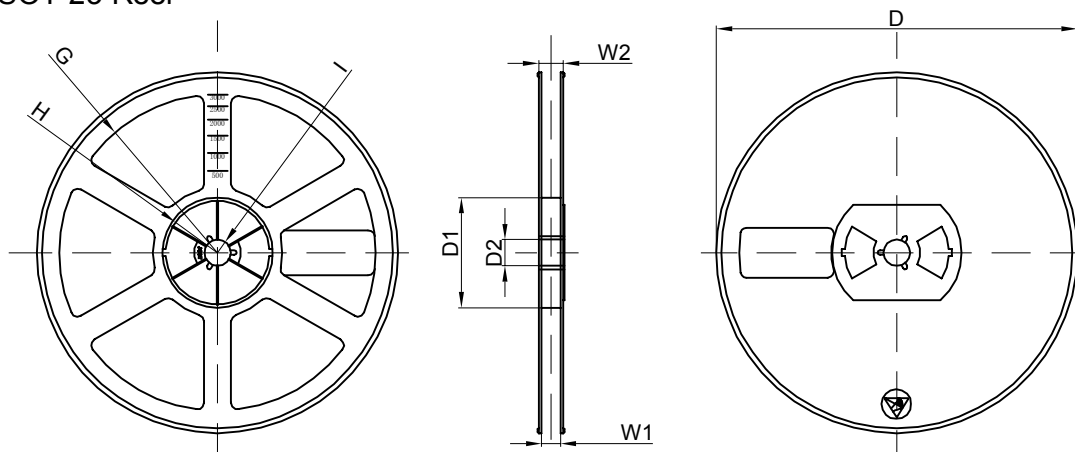

Dimensions are in millimeter								
Reel Option	D	D1	D2	G	H	I	W1	W2
7" Dia	Ø178.00	54.40	13.00	R78.00	R25.60	R6.50	9.50	12.30

REEL	Reel Size	Box	Box Size(mm)	Carton	Carton Size(mm)	G.W.(kg)
3000 pcs	7 inch	30,000 pcs	203×203×195	120,000 pcs	438×438×220	