

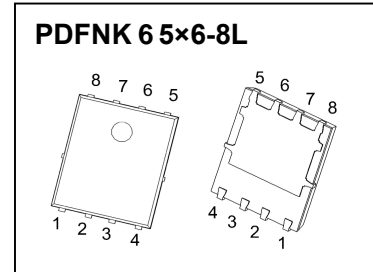

PDFNK 6 5×6-8L Plastic-Encapsulate MOSFETS

CJAC35N03 N-Channel Power MOSFET

$V_{(BR)DSS}$	$R_{DS(on)MAX}$	I_D
30V	7mΩ@10V	35A
	12mΩ@4.5V	



DESCRIPTION

The CJAC35N03 uses advanced trench technology and design to provide excellent $R_{DS(ON)}$ with low gate charge. It can be used in a wide variety of applications

FEATURES

- High density cell design for ultra low $R_{DS(ON)}$
- Fully characterized avalanche voltage and current
- Good stability and uniformity with high E_{AS}
- Excellent package for good heat dissipation
- Special process technology for high ESD capability

APPLICATIONS

- High side switch in POL DC/DC converter
- Secondary side synchronous rectifier

MARKING



CJAC35N03 = Part No.
 Solid dot=Pin1 indicator
 XXX=Date Code

EQUIVALENT CIRCUIT

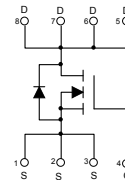

MAXIMUM RATINGS ($T_a=25^\circ\text{C}$ unless otherwise noted)

Parameter	Symbol	Limit	Unit
Drain-Source Voltage	V_{DS}	30	V
Gate-Source Voltage	V_{GS}	±20	V
Continuous Drain Current	$I_D^{(1)}$	35	A
Pulsed Drain Current	I_{DM}	120	A
Single Pulsed Avalanche Energy	$E_{AS}^{(2)}$	150	mJ
Power Dissipation	P_D	2	W
Thermal Resistance from Junction to Ambient	$R_{\theta JA}^{(1)}$	62.5	$^\circ\text{C/W}$
Junction Temperature	T_J	150	$^\circ\text{C}$
Storage Temperature Range	T_{stg}	-55 ~+150	$^\circ\text{C}$
Lead Temperature for Soldering Purposes(1/8" from case for 10s)	T_L	260	$^\circ\text{C}$

(1).Mounted on a glass epoxy board of 25.4 mm x 25.4 mm x 0.8 mm

(2). E_{AS} condition: $V_{DD}=15V, L=0.1mH, R_G=25\Omega, \text{Starting } T_J = 25^\circ\text{C}$

MOSFET ELECTRICAL CHARACTERISTICS

$T_a=25\text{ }^\circ\text{C}$ unless otherwise specified

Parameter	Symbol	Test Condition	Min	Typ	Max	Unit
Off characteristics						
Drain-source breakdown voltage	$V_{(BR)DSS}$	$V_{GS} = 0V, I_D = 250\mu A$	30			V
Zero gate voltage drain current	I_{DSS}	$V_{DS} = 30V, V_{GS} = 0V$			1	μA
Gate-body leakage current	I_{GSS}	$V_{DS} = 0V, V_{GS} = \pm 20V$			± 100	nA
On characteristics (note1)						
Gate-threshold voltage	$V_{GS(th)}$	$V_{DS} = V_{GS}, I_D = 250\mu A$	1.0	1.6	3.0	V
Static drain-source on-state resistance	$R_{DS(on)}$	$V_{GS} = 4.5V, I_D = 10A$		8.2	12	$m\Omega$
		$V_{GS} = 10V, I_D = 12A$		5.0	7.0	$m\Omega$
Forward transconductance	g_{FS}	$V_{DS} = 10V, I_D = 12A$	30			S
Dynamic characteristics (note 2)						
Input capacitance	C_{iss}	$V_{DS} = 15V, V_{GS} = 0V,$ $f = 1MHz$		1265		pF
Output capacitance	C_{oss}			600		
Reverse transfer capacitance	C_{rss}			130		
Switching characteristics (note 2)						
Total gate charge	Q_g	$V_{DS} = 15V, V_{GS} = 10V,$ $I_D = 12A$		19		nC
Gate-source charge	Q_{gs}			2.7		
Gate-drain charge	Q_{gd}			2.5		
Turn-on delay time	$t_{d(on)}$	$V_{DD} = 15V, I_D = 12A,$ $V_{GS} = 10V, R_G = 6\Omega$		18		ns
Turn-on rise time	t_r			10		
Turn-off delay time	$t_{d(off)}$			34		
Turn-off fall time	t_f			10		
Drain-Source Diode Characteristics						
Drain-source diode forward voltage(note1)	V_{SD}	$V_{GS} = 0V, I_S = 12A$		0.85	1.2	V
Continuous drain-source diode forward current(note3)	I_S				35	A
Pulsed drain-source diode forward current	I_{SM}				120	A

Notes:

1. Pulse Test : Pulse Width $\leq 300\mu s$, duty cycle $\leq 2\%$.
2. Guaranteed by design, not subject to production.
3. Surface Mounted on FR4 Board, $t \leq 10$ sec.

Typical Characteristics

Output Characteristics

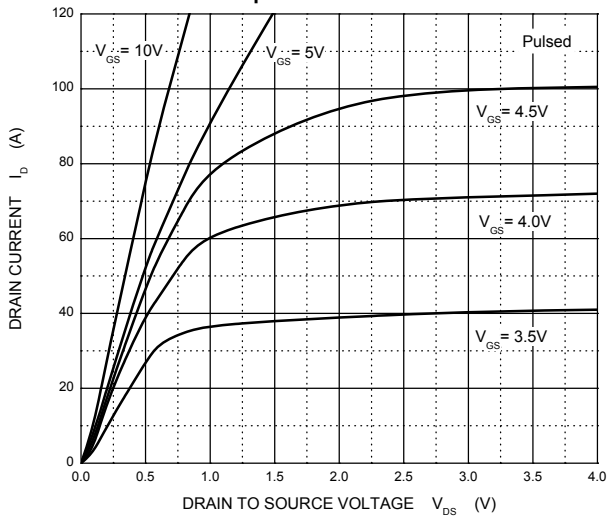

Transfer Characteristics

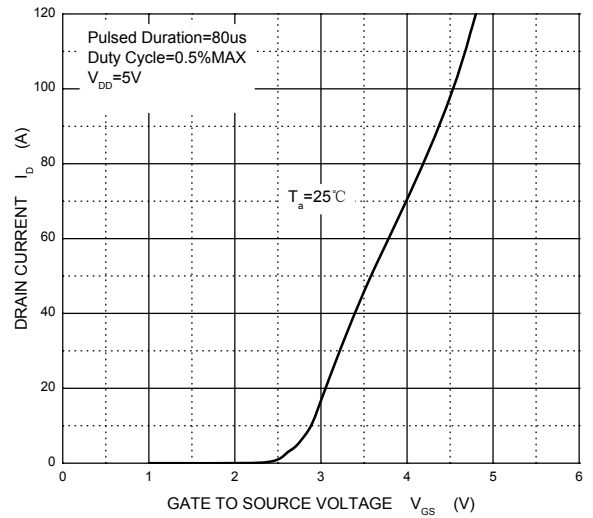

$R_{DS(ON)}$ — I_D

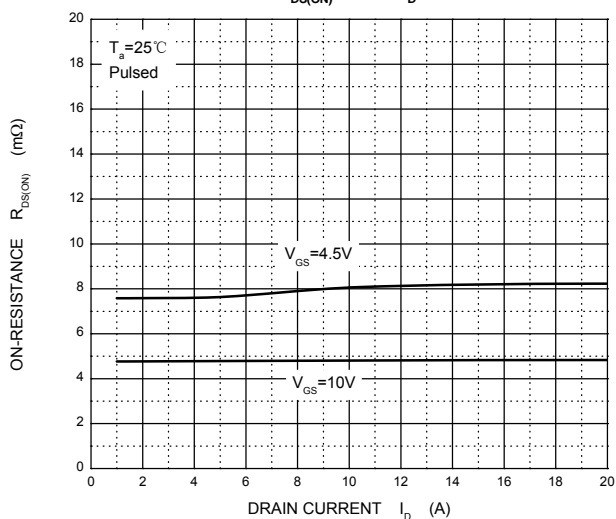

$R_{DS(ON)}$ — V_{GS}

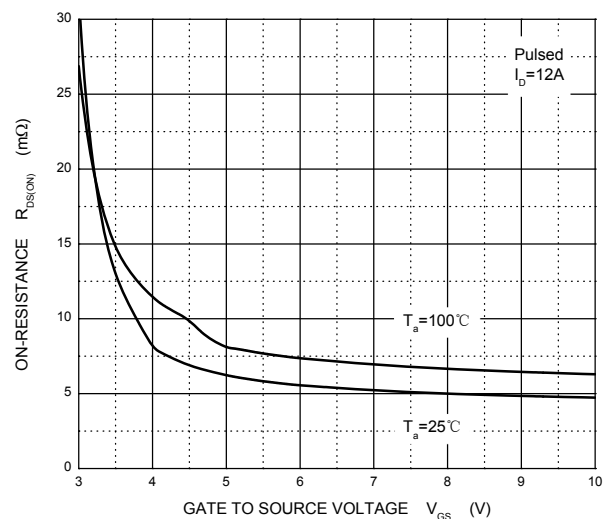

I_S — V_{SD}

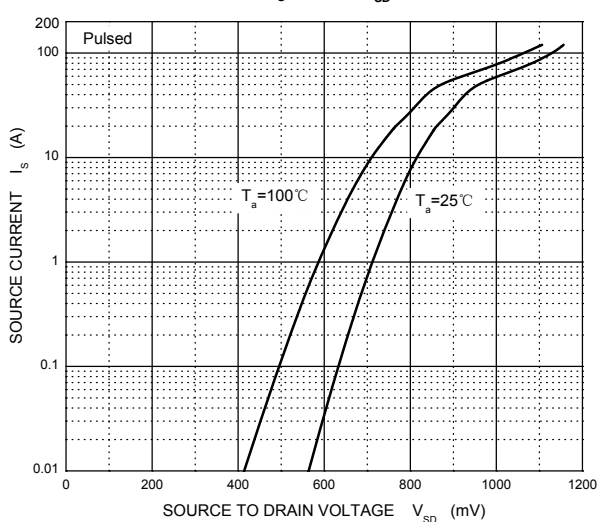

Threshold Voltage

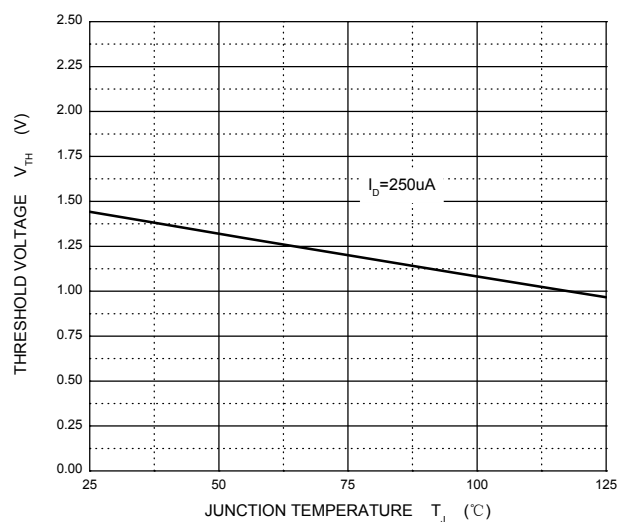

PDFNWB5x6-8L Package Outline Dimensions

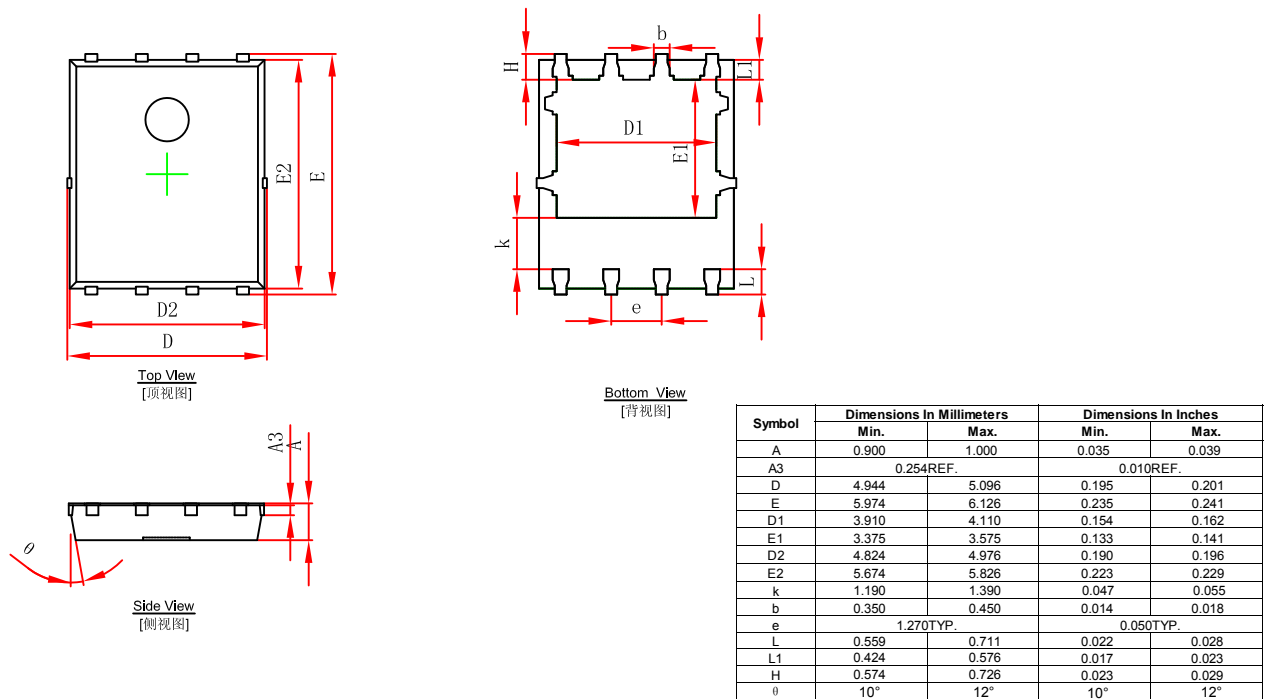

PDFNWB5x6-8L Suggested Pad Layout

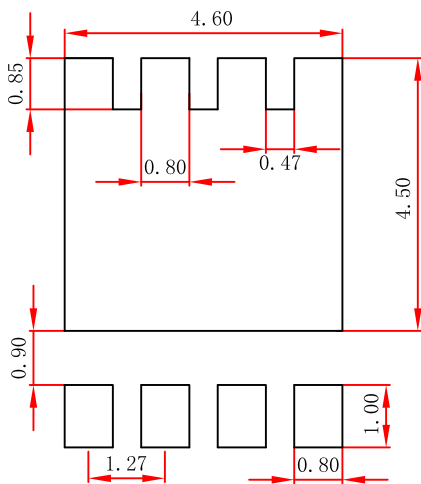

Note:

1. Controlling dimension: in millimeters.
2. General tolerance: ± 0.05 mm.
3. The pad layout is for reference purposes only.

NOTICE

JCET reserve the right to make modifications, enhancements, improvements, corrections or other changes without further notice to any product herein. JCET does not assume any liability arising out of the application or use of any product described herein.

PDFNWB5×6 Tape and Reel

PDFNWB5×6-8L Embossed Carrier Tape

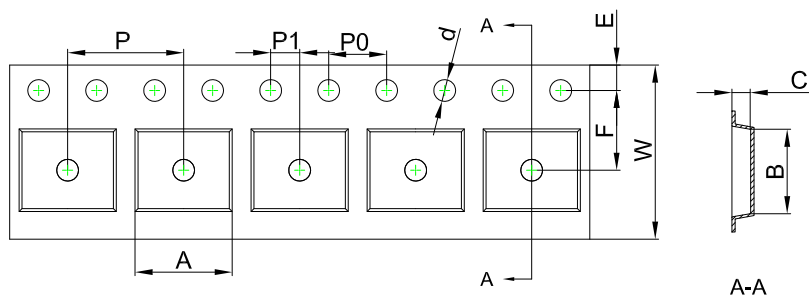

Packaging Description:
PDFNWB5×6-8L parts are shipped in tape. The carrier tape is made from a dissipative (carbon filled) polycarbonate resin. The cover tape is a multilayer film (Heat Activated Adhesive in nature) primarily composed of polyester film, adhesive layer, sealant, and anti-static sprayed agent. These reeled parts in standard option are shipped with 5,000 units per 13" or 33.0 cm diameter reel. The reels are clear in color and is made of polystyrene plastic (anti-static coated).

Dimensions are in millimeter										
Pkg type	A	B	C	d	E	F	P0	P	P1	W
PDFNWB5×6-8L	6.30	5.30	1.10	Ø1.50	1.75	5.50	4.00	8.00	2.00	12.00

PDFNWB5×6-8L Tape Leader and Trailer

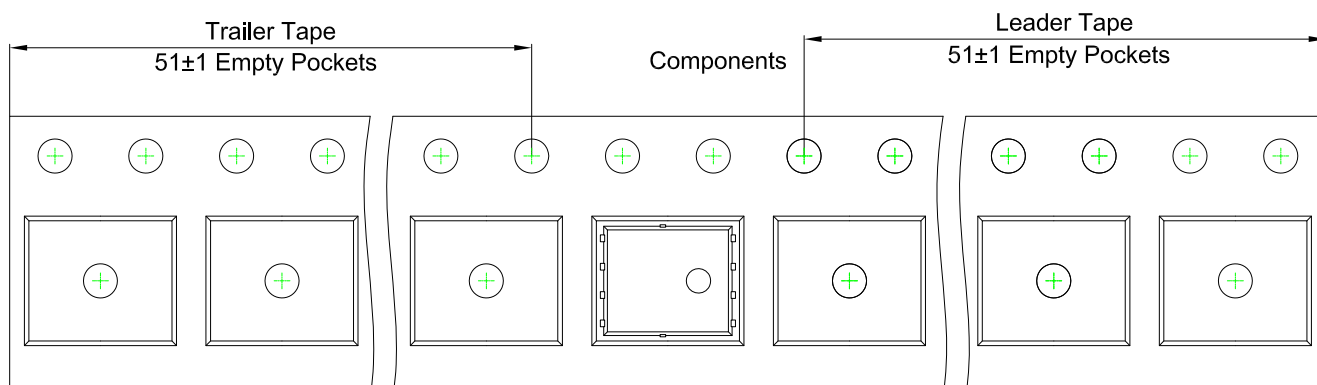

PDFNWB5×6-8L Reel

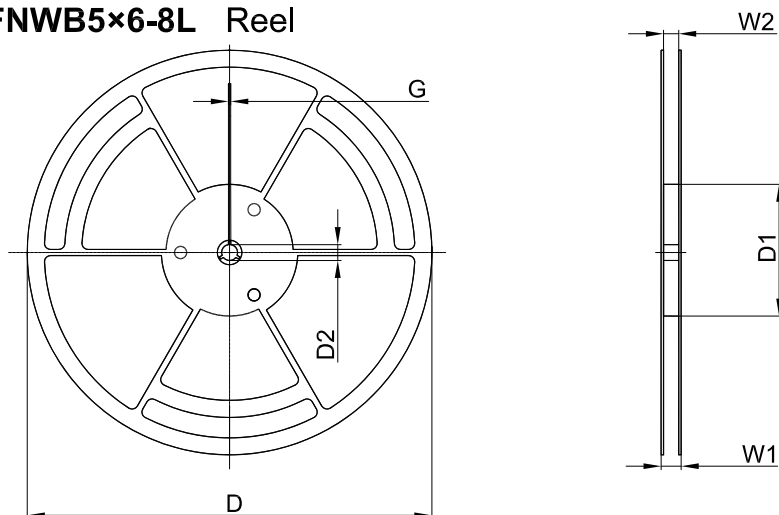

Dimensions are in millimeter						
Reel Option	D	D1	D2	G	W1	W2
13" Dia	Ø330.00	100.00	13.00	1.90	17.60	12.40

REEL	Reel Size	Box	Box Size(mm)	Carton	Carton Size(mm)
5,000 pcs	13 inch	5,000 pcs	340×336×29	50,000 pcs	353×346×365