

General Description

The MDD1951 uses advanced MagnaChip's trench MOSFET Technology to provide high performance in on-state resistance, switching performance and reliability. Low $R_{DS(ON)}$, low gate charge can be offering superior benefit in the application.

Features

- $V_{DS} = 60V$
- $I_D = 17.9A @ V_{GS} = 10V$
- $R_{DS(ON)} < 45.0m\Omega @ V_{GS} = 10V$
 $< 55.0m\Omega @ V_{GS} = 4.5V$

Applications

- Inverters
- General purpose applications

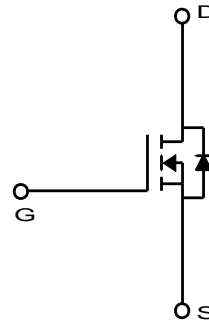
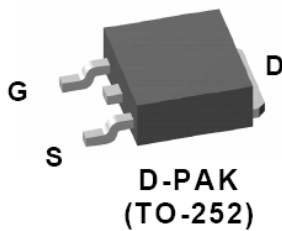

Absolute Maximum Ratings ($T_C = 25^\circ C$ unless otherwise noted)

Characteristics	Symbol	Rating	Unit	
Drain-Source Voltage	V_{DSS}	60	V	
Gate-Source Voltage	V_{GSS}	± 20	V	
Continuous Drain Current (Note 2)	I_D	$T_C=25^\circ C$ (a)	17.9	A
		$T_A=25^\circ C$ (b)	4.4	A
Pulsed Drain Current	I_{DM}	80	A	
Power Dissipation for Single Operation	P_D	$T_C=25^\circ C$	32.8	W
		$T_A=25^\circ C$	2.0	
Single Pulse Avalanche Energy (Note 3)	E_{AS}	50	mJ	
Junction and Storage Temperature Range	T_J, T_{stg}	-55~+150	$^\circ C$	

Thermal Characteristics

Characteristics	Symbol	Rating	Unit
Thermal Resistance, Junction-to-Ambient(Steady-State) (Note 1)	$R_{\theta JA}$	60	$^\circ C/W$
Thermal Resistance, Junction-to-Case	$R_{\theta JC}$	3.8	

Ordering Information

Part Number	Temp. Range	Package	Packing	RoHS Status
MDD1951RH	-55~150°C	TO-252	Tape & Reel	Halogen Free

Electrical Characteristics (T_J =25°C unless otherwise noted)

Characteristics	Symbol	Test Condition	Min	Typ	Max	Unit
Static Characteristics						
Drain-Source Breakdown Voltage	BV _{DSS}	I _D = 250μA, V _{GS} = 0V	60	-	-	V
Gate Threshold Voltage	V _{GS(th)}	V _{DS} = V _{GS} , I _D = 250μA	1.0	2.0	3.0	
Zero Gate Voltage Drain Current	I _{DSS}	V _{DS} = 60V, V _{GS} = 0V	-	-	1	μA
Gate Leakage Current	I _{GSS}	V _{GS} = ±20V, V _{DS} = 0V	-	-	0.1	
Drain-Source ON Resistance	R _{DS(ON)}	V _{GS} = 10V, I _D = 17A	-	36	45	mΩ
		V _{GS} = 4.5V, I _D = 12A	-	44	55	
Forward Transconductance	g _{FS}	V _{DS} = 5V, I _D = 17A	-	26	-	S
Dynamic Characteristics						
Total Gate Charge	Q _g	V _{DS} = 30V, I _D = 17A, V _{GS} = 4.5V	-	4.8	-	nC
Gate-Source Charge	Q _{gs}		-	1.6	-	
Gate-Drain Charge	Q _{gd}		-	2.2	-	
Input Capacitance	C _{iss}	V _{DS} = 30V, V _{GS} = 0V, f = 1.0MHz	-	470	-	pF
Reverse Transfer Capacitance	C _{rss}		-	32	-	
Output Capacitance	C _{oss}		-	70	-	
Turn-On Delay Time	t _{d(on)}	V _{GS} = 10V, V _{DS} = 30V, I _D = 17A, R _{GEN} = 5Ω	-	7.4	-	ns
Turn-On Rise Time	t _r		-	15.2	-	
Turn-Off Delay Time	t _{d(off)}		-	21.2	-	
Turn-Off Fall Time	t _f		-	7.6	-	
Drain-Source Body Diode Characteristics						
Source-Drain Diode Forward Voltage	V _{SD}	I _S = 5A, V _{GS} = 0V	-	0.8	1.2	V
Body Diode Reverse Recovery Time	t _{rr}	I _F = 17A, di/dt = 100A/μs	-	29	-	ns
Body Diode Reverse Recovery Charge	Q _{rr}		-	32	-	nC

Note :

- Surface mounted RF4 board with 2oz. Copper.
- P_D is based on T_{J(MAX)}=150°C
 - P_D (T_C=25°C) is based on R_{θJC},
 - P_D (T_A=25°C) is based on R_{θJA}, t<10sec
- Starting T_J=25°C, L=1mH, V_{GS}=10V, I_D=7A, V_{DD}=30V, Rated V_{DS}=60V,

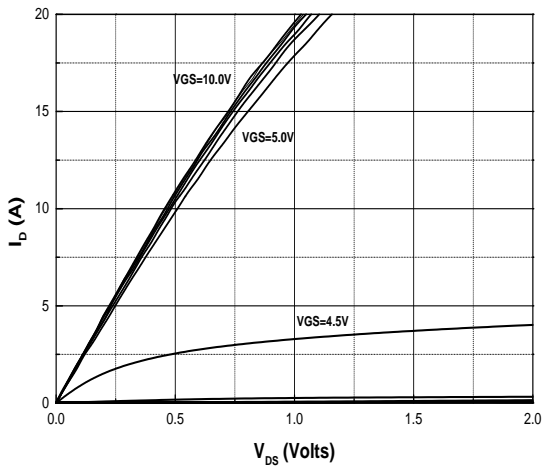

Fig.1 On-Region Characteristics

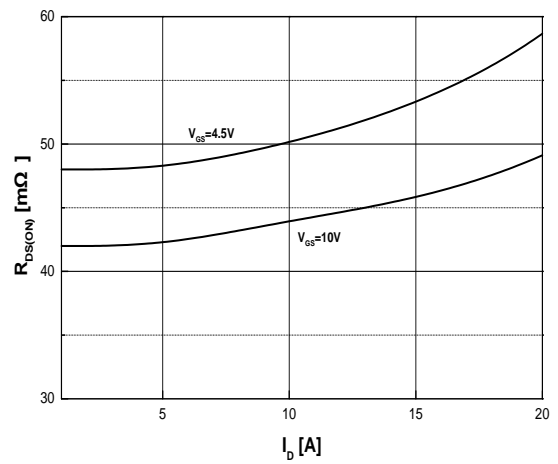

Fig.2 On-Resistance Variation with Drain Current and Gate Voltage

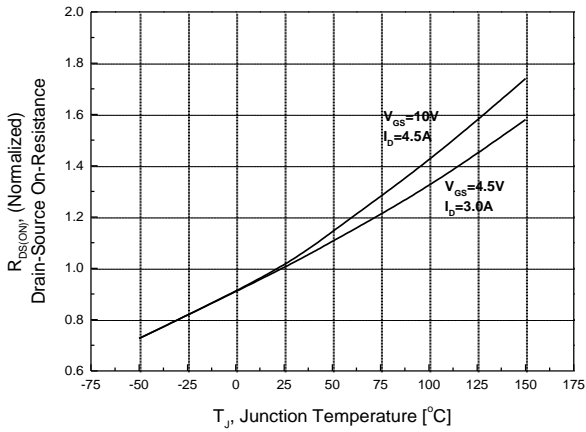

Fig.3 On-Resistance Variation with Temperature

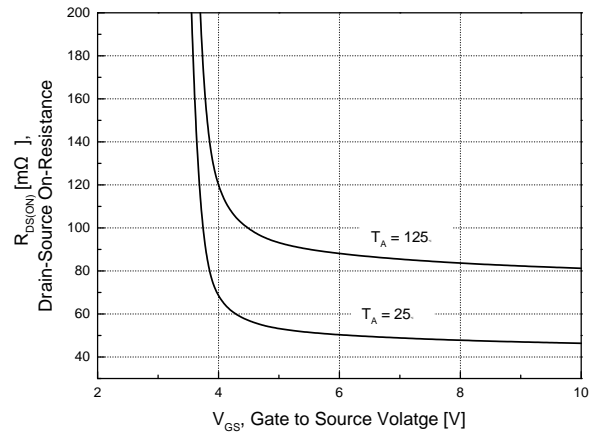

Fig.4 On-Resistance Variation with Gate to Source Voltage

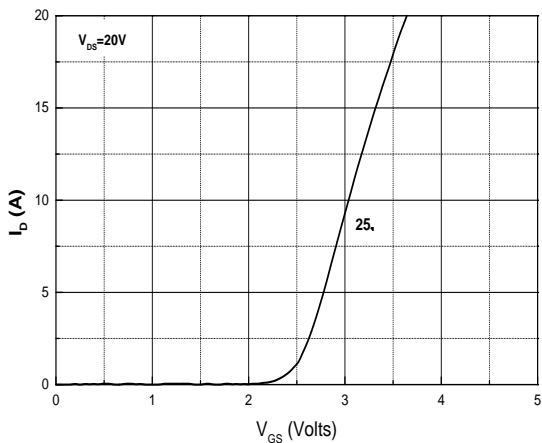

Fig.5 Transfer Characteristics

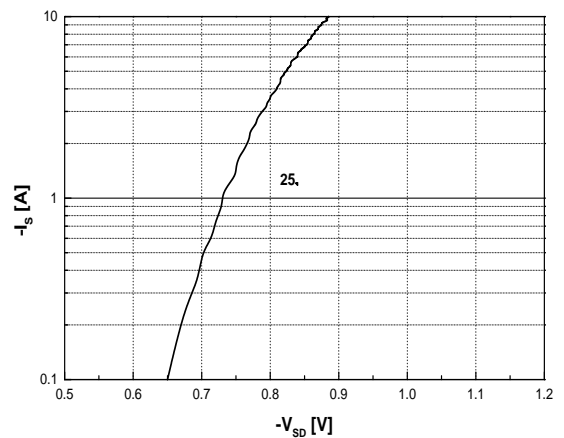

Fig.6 Body Diode Forward Voltage Variation with Source Current and Temperature

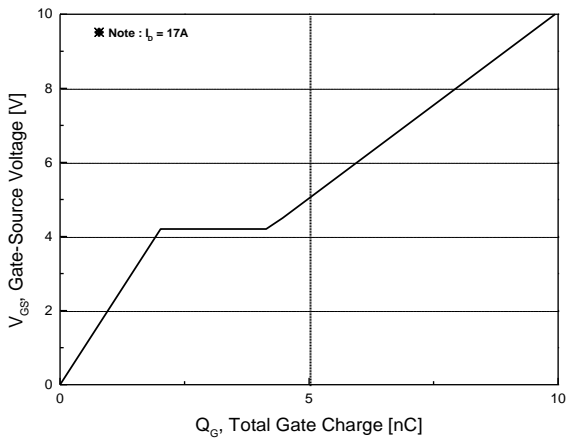

Fig.7 Gate Charge Characteristics

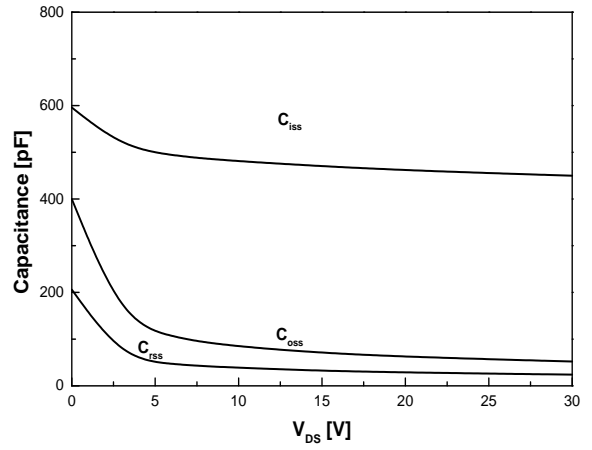

Fig.8 Capacitance Characteristics

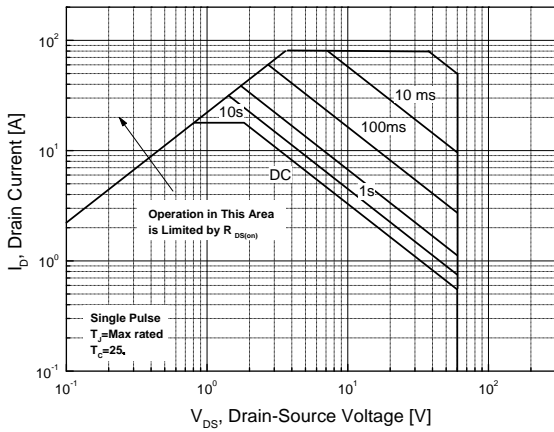

Fig.9 Maximum Safe Operating Area

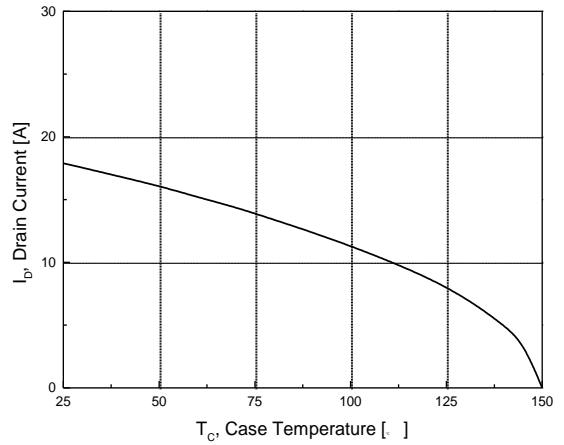

Fig.10 Maximum Drain Current Vs. Case Temperature

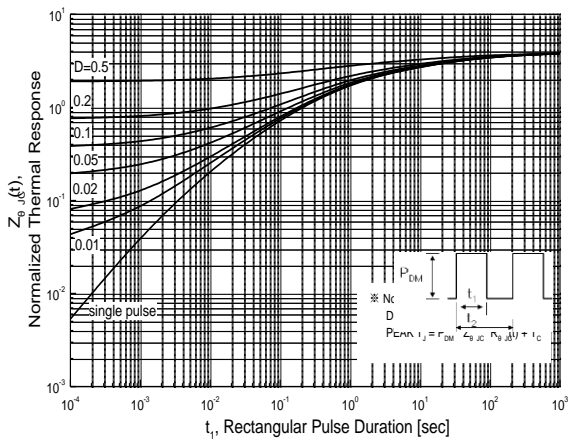
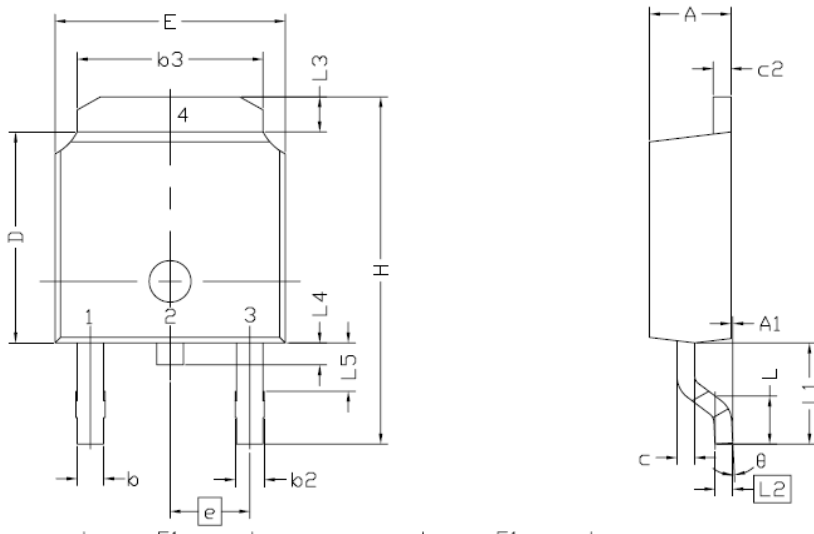

Fig.11 Transient Thermal Response Curve

Physical Dimensions

2 Leads, DPAK (TO252)

Dimensions are in millimeters unless otherwise specified



SYMBOL	DIMENSIONAL REQMTS		
	MIN	NOM	MAX
E	6.40	6.60	6.731
L	1.40	1.52	1.77
L1	2.743 REF		
L2	0.508 BSC		
L3	0.89	--	1.27
L4	0.64	--	1.01
L5	--	--	--
D	6.00	6.10	6.223
H	9.40	10.00	10.40
b	0.64	0.76	0.88
b2	0.77	0.84	1.14
b3	5.21	5.34	5.46
e	2.286 BSC		
A	2.20	2.30	2.38
A1	0	--	0.127
c	0.45	0.50	0.60
c2	0.45	0.50	0.58
D1	5.30	--	--
E1	4.40	--	--
θ	0°	--	10°

Note:

1. All Dimension Are In mm.
2. Package Body Sizes Exclude Mold Flash, Protrusion Or Gate Burrs. Mold Flash, Protrusion Or Gate Burrs Shall Not Exceed 0.10 mm Per Side.
3. Package Body Sizes Determined At The Outermost Extremes Of The Plastic Body Exclusive Of Mold Flash, Gate Burrs And Interlead Flash, But Including Any Mismatch Between The Top And Bottom Of The Plastic Body.
4. The Package Top May Be Smaller Than The Package Bottom.
5. Dimension "b" Does Not Include Dambar Protrusion. Allowable Dambar Protrusion Shall Be 0.10 mm Total In Excess Of "b" Dimension At Maximum Material Condition. The Dambar Cannot Be Located On The Lower Radius Of The Foot.

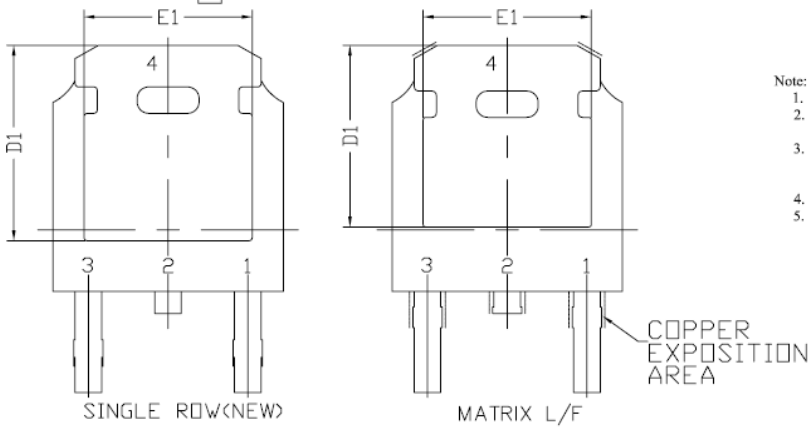

Worldwide Sales Support Locations

U.S.A

Sunnyvale Office

787 N. Mary Ave. Sunnyvale
CA 94085 U.S.A
Tel : 1-408-636-5200
Fax : 1-408-213-2450
E-Mail : americasales@magnachip.com

Chicago Office

2300 Barrington Road, Suite 330
Hoffman Estates, IL 60195 U.S.A
Tel : 1-847-882-0951
Fax : 1-847-882-0998

U.K

Knyvett House The Causeway,
Staines Middx, TW18 3BA, U.K.
Tel : +44 (0) 1784-898-8000
Fax : +44 (0) 1784-895-115
E-Mail : europesales@magnachip.com

Japan

Tokyo Office

Shinbashi 2-chome MT bldg
4F 2-5-5 Shinbashi, Minato-ku
Tokyo, 105-0004 Japan
Tel : 81-3-3595-0632
Fax : 81-3-3595-0671
E-Mail : japansales@magnachip.com

Osaka Office

3F, Shin-Osaka MT-2 Bldg
3-5-36 Miyahara Yodogawa-Ku
Osaka, 532-0003 Japan
Tel : 81-6-6394-8224
Fax : 81-6-6394-8282
E-Mail : osakasales@magnachip.com

Taiwan R.O.C

2F, No.61, Chowize Street, Nei Hu
Taipei, 114 Taiwan R.O.C
Tel : 886-2-2657-7898
Fax : 886-2-2657-8751
E-Mail : taiwansales@magnachip.com

China

Hong Kong Office

Office 03, 42/F, Office Tower Convention Plaza
1 Harbour Road, Wanchai, Hong Kong
Tel : 852-2828-9700
Fax : 852-2802-8183
E-Mail : chinasales@magnachip.com

Shenzhen Office

Room 1803, 18/F
International Chamber of Commerce Tower
Fuhua 3Road, Futian District
ShenZhen, China
Tel : 86-755-8831-5561
Fax : 86-755-8831-5565

Shanghai Office

Ste 1902, 1 Huaihai Rd. (C) 20021
Shanghai, China
Tel : 86-21-6373-5181
Fax : 86-21-6373-6640

Korea

891, Daechi-Dong, Kangnam-Gu
Seoul, 135-738 Korea
Tel : 82-2-6903-3451
Fax : 82-2-6903-3668 ~9
Email : koreasales@magnachip.com

DISCLAIMER:

The Products are not designed for use in hostile environments, including, without limitation, aircraft, nuclear power generation, medical appliances, and devices or systems in which malfunction of any Product can reasonably be expected to result in a personal injury. Seller's customers using or selling Seller's products for use in such applications do so at their own risk and agree to fully defend and indemnify Seller.

MagnaChip reserves the right to change the specifications and circuitry without notice at any time. MagnaChip does not consider responsibility for use of any circuitry other than circuitry entirely included in a MagnaChip product. [MagnaChip](#) is a registered trademark of MagnaChip Semiconductor Ltd.