

# N-Channel Enhancement Mode MOSFET

## MTB1K0N20KL3

<b>BV<sub>DSS</sub></b>	<b>200V</b>
<b>I<sub>D</sub> @ V<sub>GS</sub>=10V, T<sub>A</sub>=25°C</b>	<b>1A</b>
<b>R<sub>DSON</sub>@ V<sub>GS</sub>=10V, I<sub>D</sub>=2A</b>	<b>830mΩ (typ.)</b>
<b>R<sub>DSON</sub>@ V<sub>GS</sub>=4.5V, I<sub>D</sub>=1A</b>	<b>777mΩ (typ.)</b>

### Features

- Low Gate Charge
- Simple Drive Requirement
- ESD protected gate, HBM 6kV, typically
- Pb-free lead plating & Halogen-free package

### Equivalent Circuit

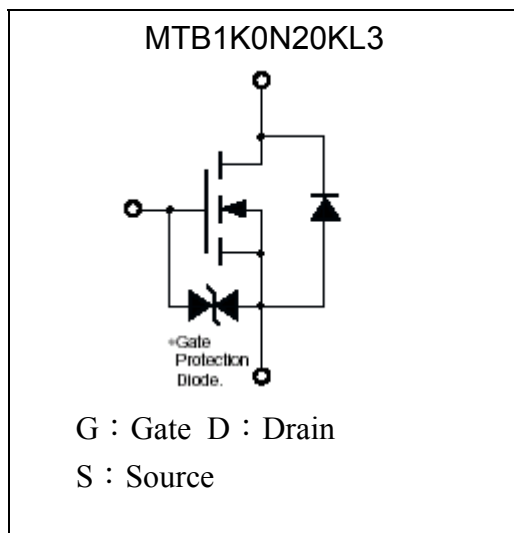

### Outline

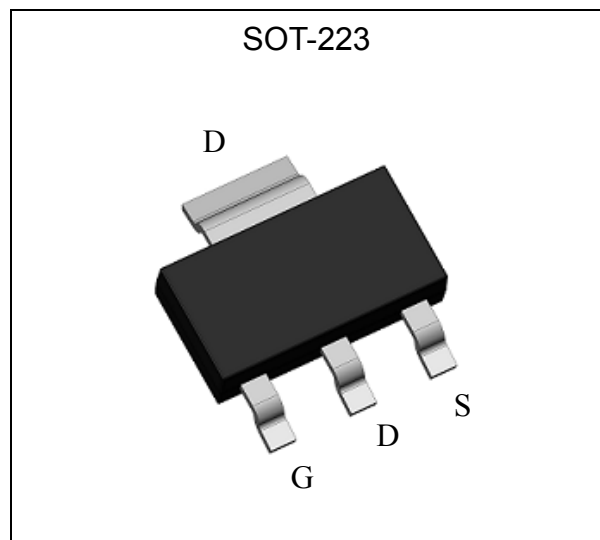

### Ordering Information

Device	Package	Shipping
MTB1K0N20KL3-0-T3-G	SOT-223 (Pb-free lead plating & Halogen-free package)	2500 pcs / Tape & Reel

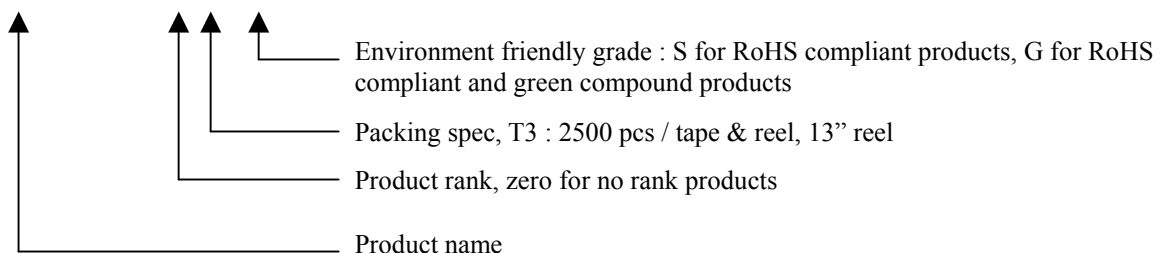



**Absolute Maximum Ratings** (T<sub>C</sub>=25°C, unless otherwise noted)

Parameter	Symbol	Limits	Unit
Drain-Source Voltage	V <sub>DS</sub>	200	V
Gate-Source Voltage	V <sub>GS</sub>	±20	
Continuous Drain Current @ T <sub>A</sub> =25°C, V <sub>GS</sub> =10V	I <sub>D</sub>	1	A
Continuous Drain Current @ T <sub>A</sub> =70°C, V <sub>GS</sub> =10V		0.8	
Pulsed Drain Current *1	I <sub>DM</sub>	4	
Avalanche Current @ L=0.1mH	I <sub>AS</sub>	2	
Avalanche Energy @ L=1mH, I <sub>D</sub> =2A, V <sub>DD</sub> =50V *2	E <sub>AS</sub>	2	mJ
Repetitive Avalanche Energy @ L=0.05mH	E <sub>AR</sub>	0.625	
ESD susceptibility *3	V <sub>ESD</sub>	6000	V
Total Power Dissipation @ T <sub>A</sub> =25°C	P <sub>D</sub>	2.4	W
Total Power Dissipation @ T <sub>A</sub> =70°C		1.5	
Operating Junction and Storage Temperature Range	T <sub>j</sub> , T <sub>stg</sub>	-55~+150	°C

Note : \*1. Pulse width limited by maximum junction temperature  
 \*2. Guaranteed by design, not by 100% test.  
 \*3. Human body model, 1.5kΩ in series with 100pF

**Thermal Data**

Parameter	Symbol	Value	Unit
Thermal Resistance, Junction-to-case, max	R <sub>θJC</sub>	10	°C/W
Thermal Resistance, Junction-to-ambient, max	R <sub>θJA</sub>	52 (Note)	

Note : When mounted on a 1 in<sup>2</sup> pad of 2 oz. copper.

**Characteristics (T<sub>C</sub>=25°C, unless otherwise specified)**

Symbol	Min.	Typ.	Max.	Unit	Test Conditions
<b>Static</b>					
BV <sub>DSS</sub>	200	-	-	V	V <sub>GS</sub> =0V, I <sub>D</sub> =250μA
V <sub>GS(th)</sub>	1	-	3		V <sub>DS</sub> =V <sub>GS</sub> , I <sub>D</sub> =250μA
G <sub>FS</sub> *1	-	3.1	-	S	V <sub>DS</sub> =10V, I <sub>D</sub> =1A
I <sub>GSS</sub>	-	-	±10	μA	V <sub>GS</sub> =±16V, V <sub>DS</sub> =0V
I <sub>DSS</sub>	-	-	1		V <sub>DS</sub> =160V, V <sub>GS</sub> =0V
	-	-	25		V <sub>DS</sub> =160V, V <sub>GS</sub> =0V, T <sub>j</sub> =125°C
R <sub>DS(ON)</sub> *1	-	0.83	1.08	Ω	V <sub>GS</sub> =10V, I <sub>D</sub> =2A
	-	0.78	1.6		V <sub>GS</sub> =4.5V, I <sub>D</sub> =1A
<b>Dynamic</b>					
Q <sub>g</sub> *1, 2	-	5.2	7.8	nC	V <sub>DS</sub> =150V, V <sub>GS</sub> =5V, I <sub>D</sub> =3.6A
Q <sub>gs</sub> *1, 2	-	1	1.5		
Q <sub>gd</sub> *1, 2	-	2.8	4.2		
t <sub>d(ON)</sub> *1, 2	-	39	58.5	ns	V <sub>DS</sub> =100V, I <sub>D</sub> =3.6A, V <sub>GS</sub> =5V, R <sub>G</sub> =25Ω
t <sub>r</sub> *1, 2	-	80.4	120.6		
t <sub>d(OFF)</sub> *1, 2	-	94.2	141.3		
t <sub>f</sub> *1, 2	-	59.2	88.8		

Ciss	-	273	409.5	pF	V <sub>GS</sub> =0V, V <sub>DS</sub> =30V, f=1MHz
Coss	-	21	31.5		
Crss	-	23	34.5		
<b>Source-Drain Diode</b>					
I <sub>S</sub> *1	-	-	1	A	
I <sub>SM</sub> *3	-	-	4		
V <sub>SD</sub> *1	-	0.8	1	V	I <sub>S</sub> =1A, V <sub>GS</sub> =0V
trr	-	46.8	-	ns	I <sub>F</sub> =3.6A, dI <sub>F</sub> /dt=100A/μs
Qrr	-	72.2	-	nC	

Note : \*1.Pulse Test : Pulse Width ≤300μs, Duty Cycle≤2%  
 \*2.Independent of operating temperature  
 \*3.Pulse width limited by maximum junction temperature.

**Recommended soldering footprint**

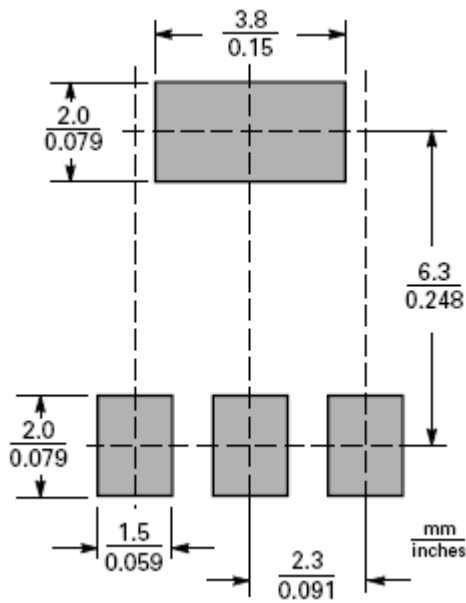



**Typical Characteristics**

Typical Output Characteristics

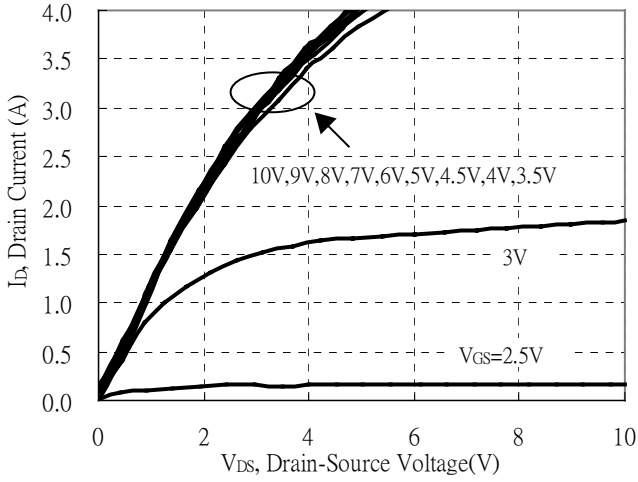

Brekdown Voltage vs Junction Temperature

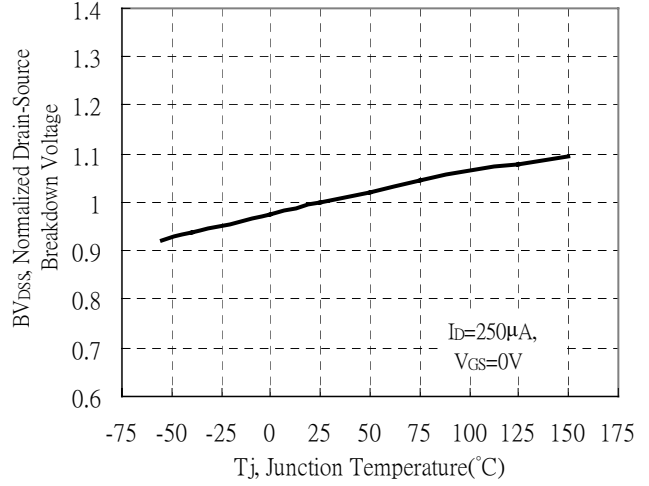

Static Drain-Source On-State resistance vs Drain Current

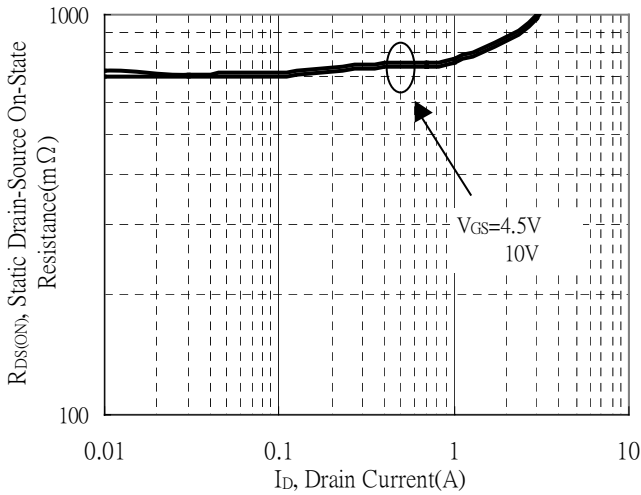

Reverse Drain Current vs Source-Drain Voltage

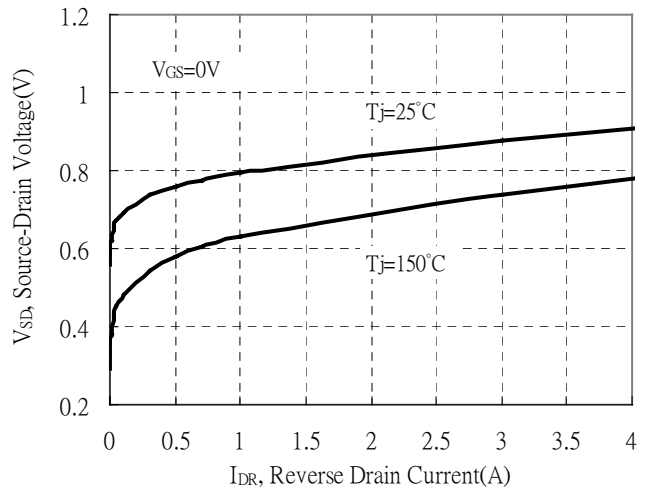

Static Drain-Source On-State Resistance vs Gate-Source Voltage

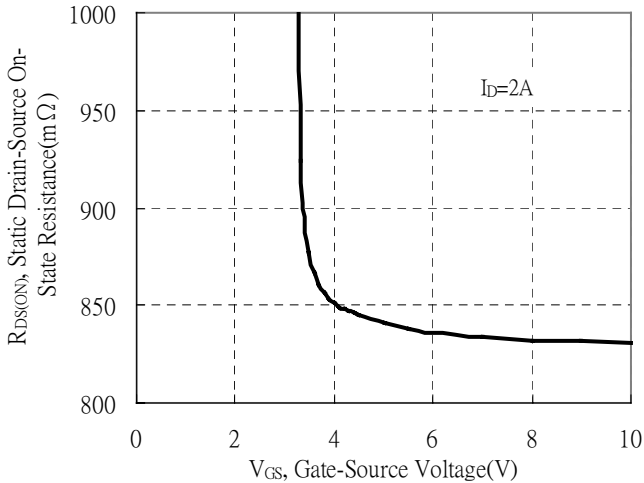

Drain-Source On-State Resistance vs Junction Temperature

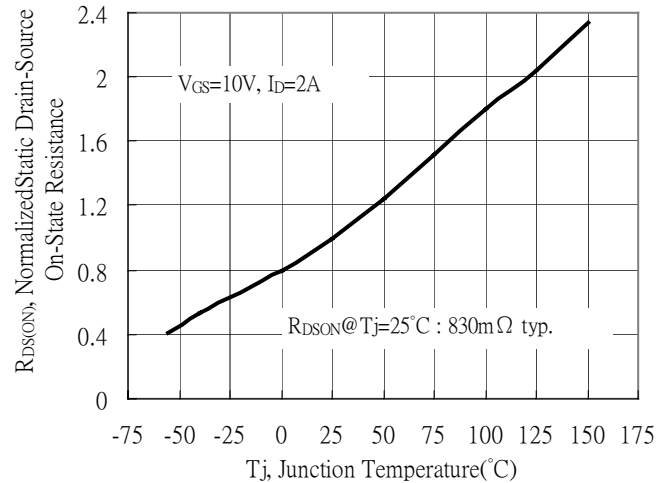

## Typical Characteristics(Cont.)

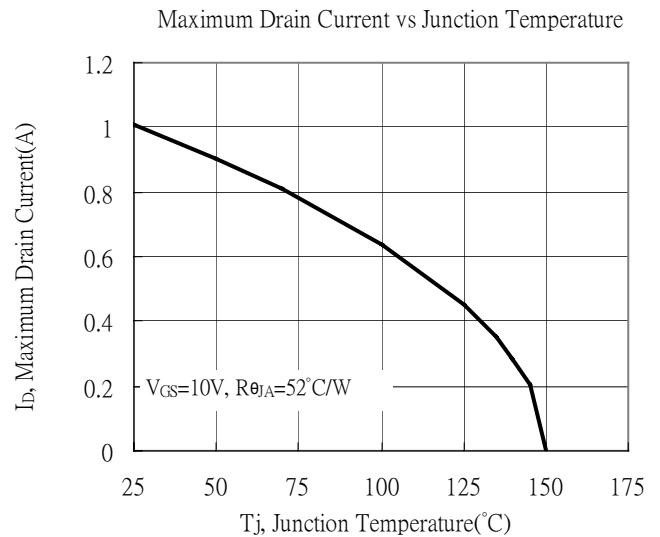
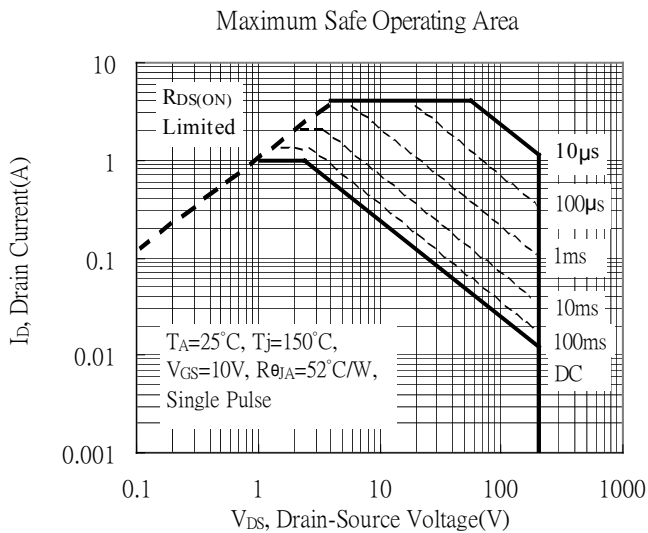
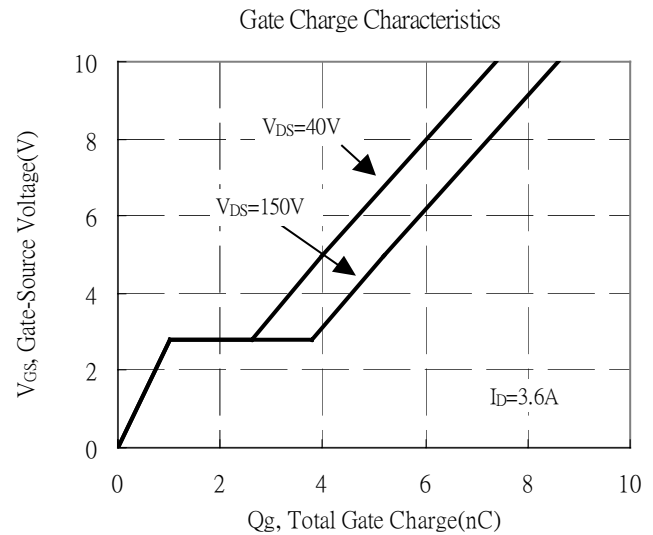
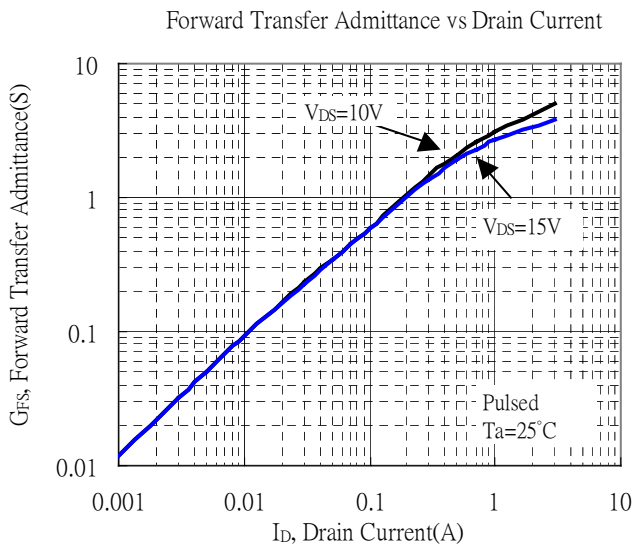
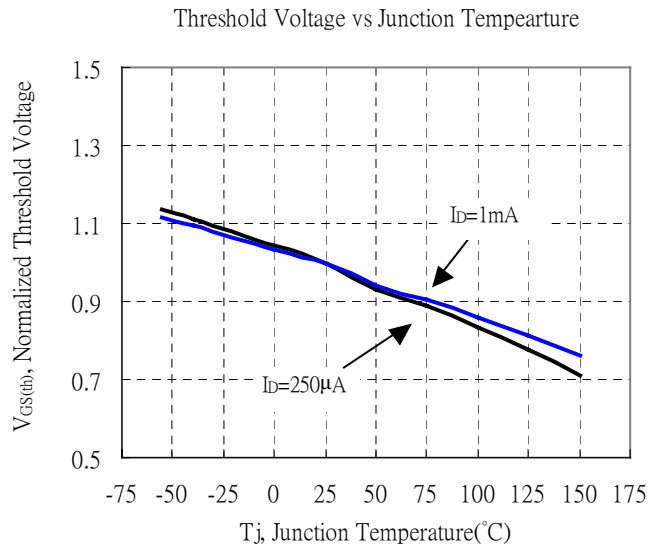
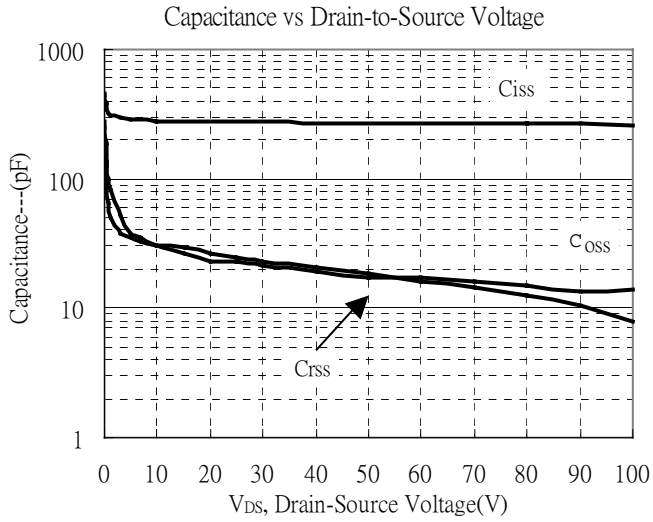



**Typical Characteristics(Cont.)**

Typical Transfer Characteristics

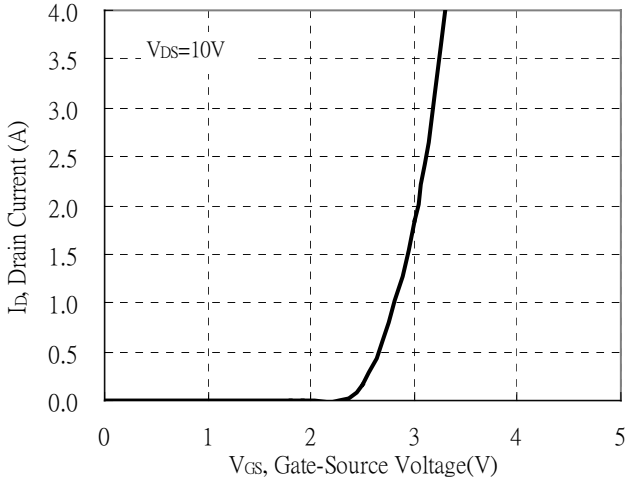

Single Pulse Power Rating, Junction to Ambient  
 (Note on page 2)

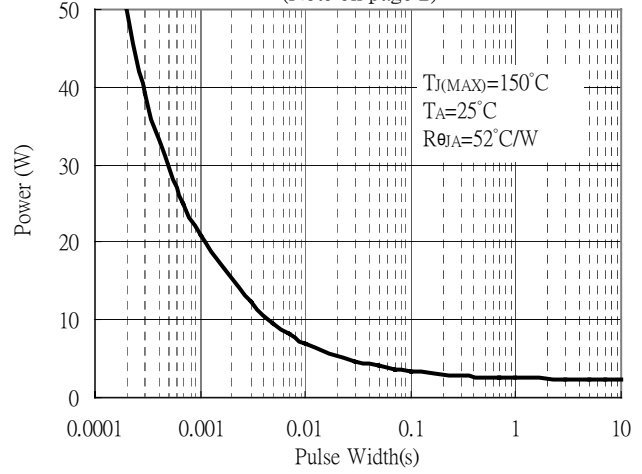

Transient Thermal Response Curves

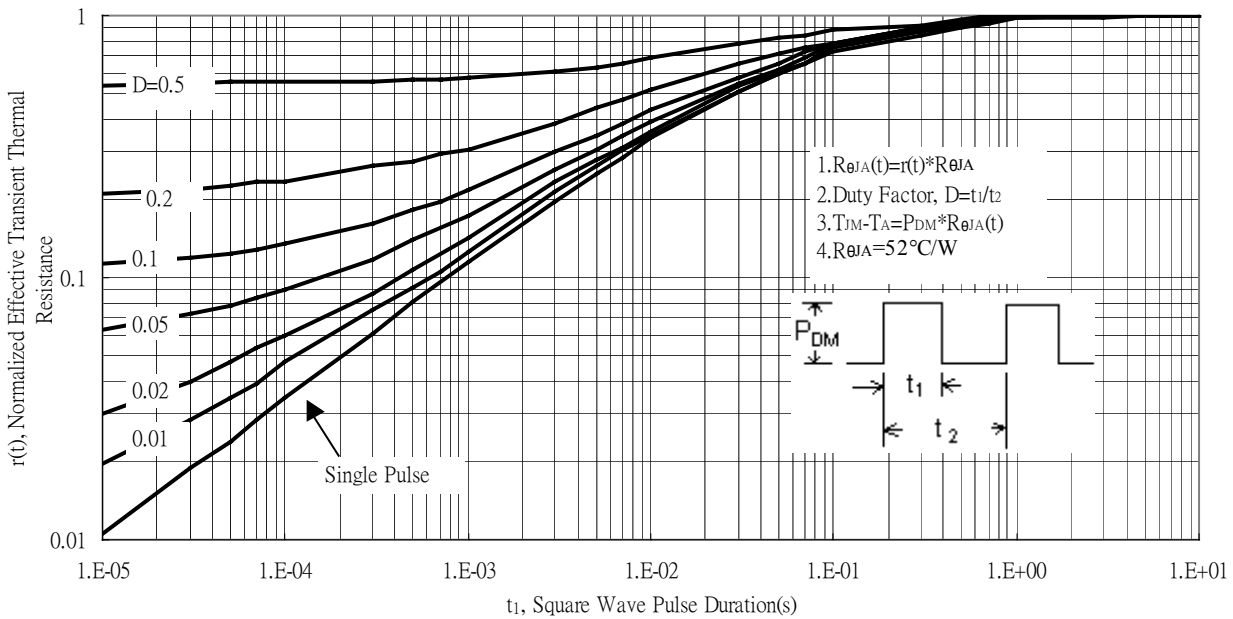

**Reel Dimension**

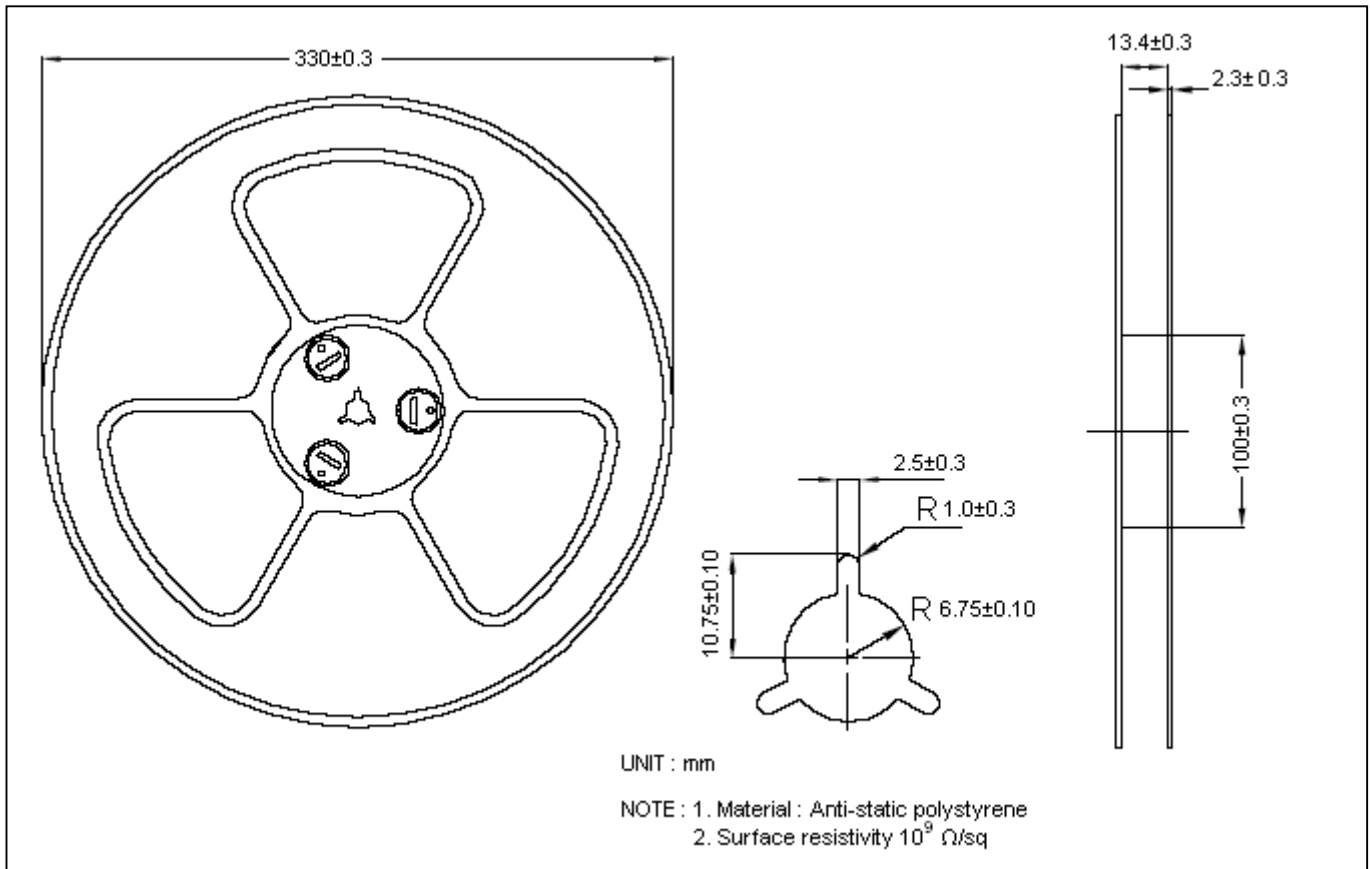

**Carrier Tape Dimension**

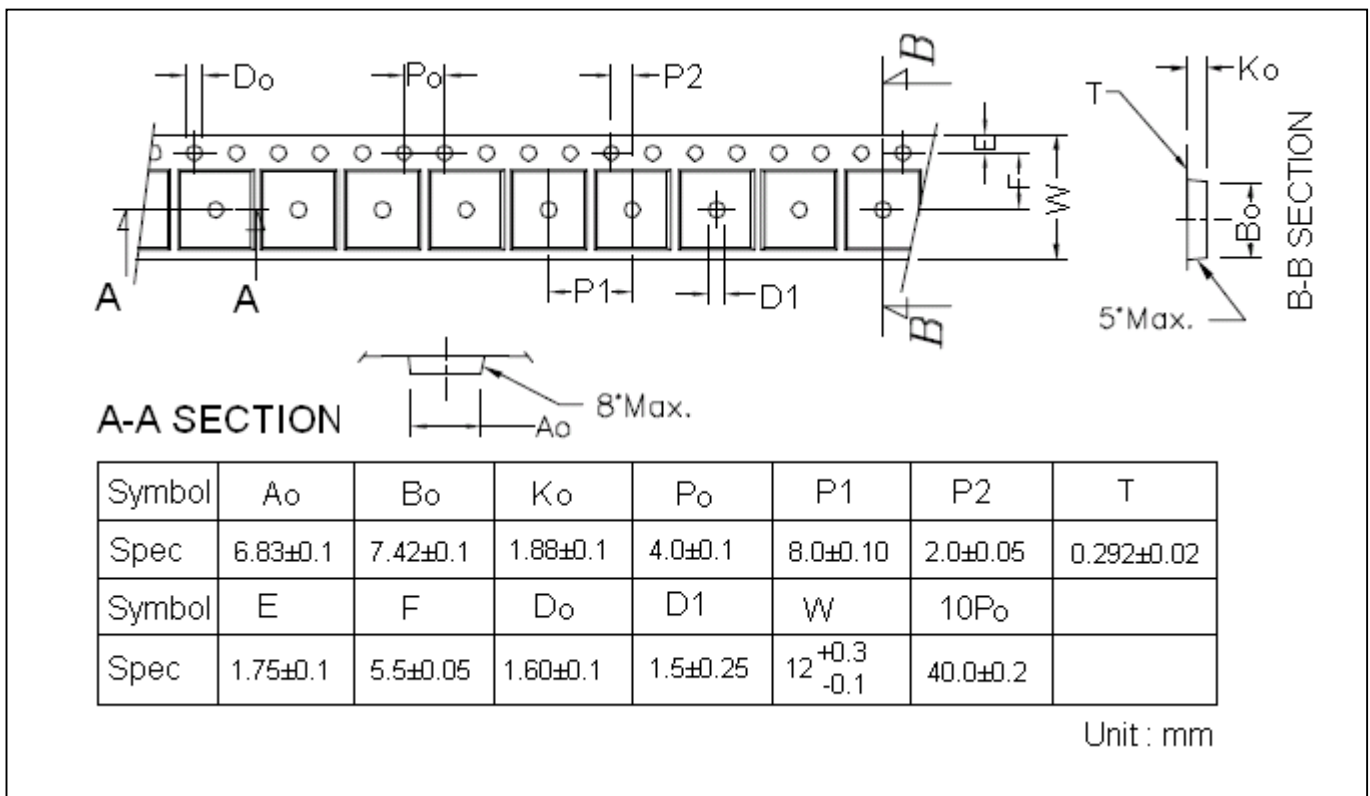

**Recommended wave soldering condition**

Product	Peak Temperature	Soldering Time
Pb-free devices	260 +0/-5 °C	5 +1/-1 seconds

**Recommended temperature profile for IR reflow**



Profile feature	Sn-Pb eutectic Assembly	Pb-free Assembly
Average ramp-up rate (T <sub>smax</sub> to T <sub>p</sub> )	3°C/second max.	3°C/second max.
Preheat		
-Temperature Min(T <sub>s min</sub> )	100°C	150°C
-Temperature Max(T <sub>s max</sub> )	150°C	200°C
-Time(t <sub>s min</sub> to t <sub>s max</sub> )	60-120 seconds	60-180 seconds
Time maintained above:		
-Temperature (T <sub>L</sub> )	183°C	217°C
- Time (t <sub>L</sub> )	60-150 seconds	60-150 seconds
Peak Temperature(T <sub>P</sub> )	240 +0/-5 °C	260 +0/-5 °C
Time within 5°C of actual peak temperature(t <sub>p</sub> )	10-30 seconds	20-40 seconds
Ramp down rate	6°C/second max.	6°C/second max.
Time 25 °C to peak temperature	6 minutes max.	8 minutes max.

Note : All temperatures refer to topside of the package, measured on the package body surface.



**SOT-223 Dimension**

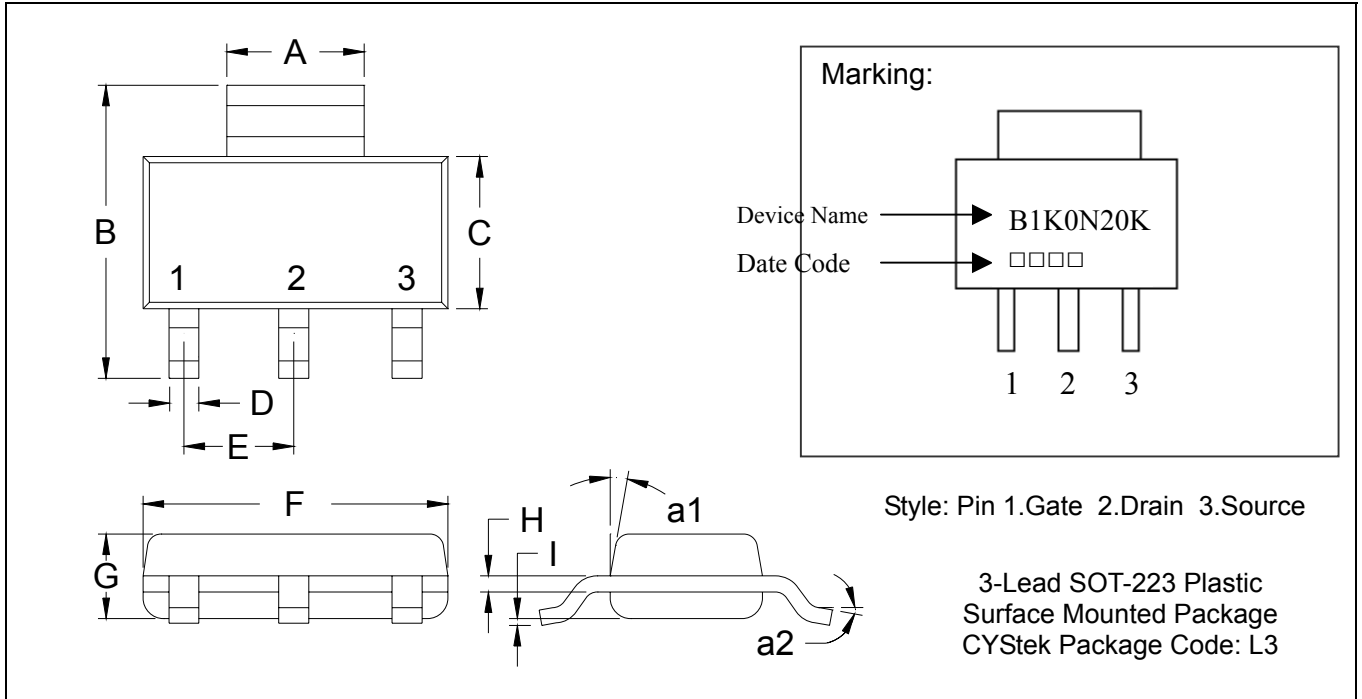

\*: Typical

DIM	Inches		Millimeters		DIM	Inches		Millimeters	
	Min.	Max.	Min.	Max.		Min.	Max.	Min.	Max.
A	0.1142	0.1220	2.90	3.10	G	0.0551	0.0709	1.40	1.80
B	0.2638	0.2874	6.70	7.30	H	0.0098	0.0138	0.25	0.35
C	0.1299	0.1457	3.30	3.70	I	0.0008	0.0039	0.02	0.10
D	0.0236	0.0315	0.60	0.80	a1	*13°	-	*13°	-
E	*0.0906	-	*2.30	-	a2	0°	10°	0°	10°
F	0.2480	0.2638	6.30	6.70					

- Notes: 1.Controlling dimension: millimeters.  
 2.Maximum lead thickness includes lead finish thickness, and minimum lead thickness is the minimum thickness of base material.  
 3.If there is any question with packing specification or packing method, please contact your local CYStek sales office.

**Material:**

- Lead: Pure tin plated.
- Mold Compound: Epoxy resin family, flammability solid burning class: UL94V-0.

**Important Notice:**

- All rights are reserved. Reproduction in whole or in part is prohibited without the prior written approval of CYStek.
- CYStek reserves the right to make changes to its products without notice.
- CYStek **semiconductor products are not warranted to be suitable for use in Life-Support Applications, or systems.**
- CYStek assumes no liability for any consequence of customer product design, infringement of patents, or application assistance.