



LinearDimensions
SEMICONDUCTOR

LND 3526

DUAL USB POWER CONTROL SWITCH

GENERAL DESCRIPTION

The LND3526, is a dual high side power control switch, with independent enable and flag functions optimized for self powered and bus-powered universal serial bus (USB) applications.

The LND3526 satisfies the following USB requirements: Each switch channel supplies up to 500mA with internal circuitry limiting the fault current to 750mA. The switch's 140mΩ on-resistance meets USB voltage drop requirements. A flag output is available to indicate fault conditions to the local USB controller.

Additional features include: lockout (UVLO) to ensure that the device remains off until there is a valid input voltage present, thermal shutdown to prevent switch failure from high current loads and 3.3V and 5V logic compatible enable inputs.

The LND3526 is available in active-high and active-low versions in 8-pin die and SOIC packages.

FEATURES

- USB specification compliant
- Over-Current Protection
- 2 independent switches
- 140 mΩ maximum on-resistance
- Thermal shutdown
- 5μA Maximum standby supply current
- 2.4V typical under-voltage lockout (UVLO)
- 3V to 5.5V input
- Active-high or active-low ENABLE versions
- Independent open drain fault flag pins
- 500mA continuous load current per switch

APPLICATIONS

- USB host and self powered hubs
- USB bus-powered hubs
- USB monitors, printers, cameras and other USB controlled peripherals
- Hot plug-in power supplies
- Battery charger circuits



ABSOLUTE MAXIMUM RATINGS (note 1)

Parameter	Symbol	Ratings	Units
Input Supply Voltage	V_{IN}	+6	V
Fault Flag Voltage	V_{FLG}	+6	V
Fault Flag Current	I_{FLG}	50	mA
Output Voltage	V_{OUT}	+6	V
Output Current	I_{OUT}	Internally limited	mA
ENABLE Input Voltage	V_{EN}	-0.3 to + 5.5	V
Storage Temperature	T_{STG}	-65 to +150	°C
Operating Ambient Temperature	T_A	-40 to +85	°C

ELECTRICAL CHARACTERISTICS

$T_A = 25^\circ\text{C}$, $V_{IN} = +5\text{V}$; unless specified

Parameter	Symbol	Conditions	Min	Typ	Max	Units
Supply Current	I_{DDOFF}	All Switches OFF OUT= Open (note 3)		0.75	5	μA
	I_{DDON}	All switches ON OUT=Open (note 3)		110	160	μA
ENABLE Input Threshold (active Low)	V_{ENTL}	High to Low Transition (Turn -on)	0.8	1.90		V
	V_{ENTH}	Low to High Transition (Turn-off)		2.1	2.4	V
ENABLE Input Current	I_{EN}	$V_{EN} = 0\text{V to } 5.5\text{V}$	-1	± 0.01	1	μA
ENABLE Input Capacitance	C_{EN}			1		pF
Switch resistance	R_{ON}	Each switch ON $I_{OUT} = 500\text{mA}$	5V	100	140	$\text{m}\Omega$
			3.3V	140	180	
Output Turn-on Delay	T_{ON}	$R_L = 10\Omega$ each output		0.5		ms
Output Turn-on Rise Time	T_R	$R_L = 10\Omega$ each output		1		ms
Output Turn-off Delay	T_{OFF}	$R_L = 10\Omega$ each output		1	20	μs
Output Turn-off Fall time	T_F	$R_L = 10\Omega$ each output		1	20	μs
Output Leakage Current	I_{OL}	Output disabled, each output			10	μA
Continuous Load Current	I_{OUT}	Each output	0.5			A
Short Circuit Current Limit	I_{SCL}	ENABLE into Load, $V_{OUT} = 4.0\text{V}$	0.5	0.75	1.25	A
Current Limit Threshold	I_{LTH}	Ramped load to enabled output $V_{OUT} < 4.0\text{V}$		1.6	2.2	A
Over Temperature Shutdown Threshold	O_{TTH}	T_J (Junction temp) :Increasing :Decreasing		135		°C
				125		°C
Error Flag Output Resistance	R_{FLG}	$V_{IN} = 5\text{V}, I_L = 10\text{mA}$ $V_{IN} = 3.3\text{V}, I_L = 10\text{mA}$		10	25	Ω
				15	40	Ω
Error Flag Off Current	I_{FLG}	$V_{FLG} = 5\text{V}$		0.01	1	μA
Under Voltage Lockout Threshold	UVLO	V_{IN} = increasing V_{IN} = decreasing		2.5		V
				2.3		

Note 1. Exceeding the absolute maximum rating may damage the device

Note 2. The device is not guaranteed to function outside its operating rating

Note 3. Off is ≤ 0.8 and on is $\geq 2.4\text{V}$ for the LND3526-1. Off is $\geq 2.4\text{V}$ and is 0.8V for the LND3526-2. The enable input has approximately 200mV of hysteresis.



FUNCTIONAL DESCRIPTION

Input and Output

IN is power supply connection to the logic circuitry and the drain of the output MOSFET. In a typical circuit, current flows from IN to OUT toward the load. If V_{out} is greater than V_{IN} , current will flow from out to in, since the switch is bi-directional when enabled. The output MOSFET and driver circuitry are also designed to allow the MOSFET source to be externally forced to a higher voltage than the drain ($V_{out} > V_{in}$) when the switch is disabled. In this situation, the LND3526 prevents undesirable current flow from OUT to IN.

Thermal Shutdown

Thermal shutdown is employed to protect the device from damage should the die temperature exceed safe margins due mainly to short circuit faults. Each channel employs its own thermal sensor. Thermal shutdown shuts off the output MOSFET and asserts the FLG output if the die temperature reaches 135°C. The other channel is not effected.

The LND3526 will automatically reset its output when the die temperature cools down to 125°C. The LND3526 output and FLG signal will continue to cycle on and off until the device is disabled or the fault is removed.

Depending on PCB layout, package, ambient temperature etc., it may take several hundred milliseconds from the incidence of the fault to the output MOSFET being shut off.

Current-limit response

The current-limit threshold is present internally. The preset level prevents damage to the output MOSFET and external load but allows a minimum current of 0.5A through the output MOSFET of each channel. The current-limit circuit senses a portion of the output FET switch current. The reaction to an overcurrent condition varies with three scenarios:

(i) Switch Enabled into Short Circuit

If a switch is powered on or enabled into a heavy load of short circuit, the switch immediately goes into constant-current mode, reducing the output voltage. The fault flag goes low until the load is reduced.

(ii) Short Circuit Applied to Output

When a heavy load is applied, a large transient current may flow until the current limit circuitry will respond. Once this occurs, the device limits current to less than the short-circuit current limit specification.

(iii) Current-Limit Response

The LND3526 current-limit profile exhibits a small foldback effect of approximately 500mA. Once this current-limit threshold is exceeded the device enters constant-current mode. This constant current is specified as the short circuit current limit in the "Electrical Characteristics" table. It is important to note that the device will deliver load current up to the current-limit threshold, which is typically 1.6A

Fault Flag

FLG is an N-channel, open-drain MOSFET output. The fault-flag is active (low) for one or more of the following conditions: undervoltage (while $2V < V_{in} < 2.7$), current limit, or thermal shutdown.

Undervoltage Lockout

UVLO (undervoltage lockout) prevents the output MOSFET from turning on until V_{IN} exceeds approximately 2.5V. In the undervoltage state, the FLAG will be low. After the switch turns on, if the voltage drops below approximately 2.3V, UVLO shuts off the output MOSFET and signals fault flag. Undervoltage detection functions only when at least one switch is enabled.



APPLICATIONS INFORMATION

Enable Input

As with any logic input, the enable pins, ENA/ENB, must be driven to definitive logic state at all times. Floating the input can result in spurious operation. Do not drive ENA/ENB below GND.

Fault Flag Output Soft Start

The LND3526 provides a “Soft-Start” function that ramps up the ON-current to eliminate any excessive voltage drop that could occur due to charging a capacitive load in bus-powered applications. The “Soft-Start” results from a switch ON resistance, R_{ON} , that is ramped down from high impedance to $140m\Omega$ in milliseconds. This R_{ON} ramping reduces the inrush current and related transients occur when charging capacitive loads; a requirement for meeting the USB voltage drop standards for bus-powered applications.

Supply Filtering

LDI recommends the use of a $0.1\mu F$ to $1\mu F$ bypass capacitor to control transients on the power supply pin. The lack of suitable bypassing can result in ringing on the IN input when transients occur. This ringing, due to supply lead inductance, could damage LND3526 control circuitry if the $5.5V$ maximum input rating is exceeded.

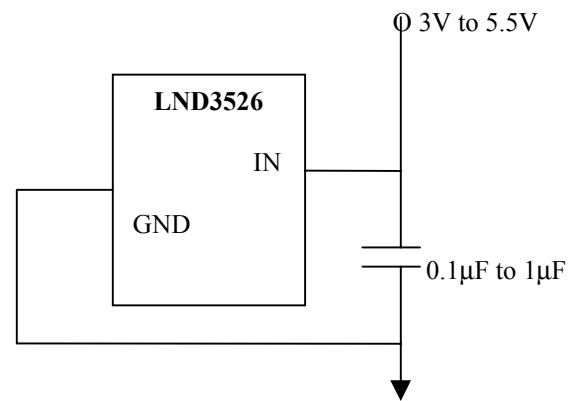

TIMING DIAGRAMS

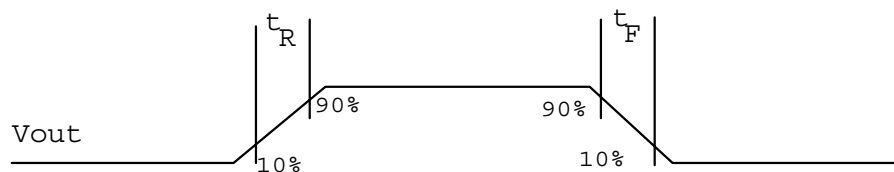

Output Rise and Fall Times

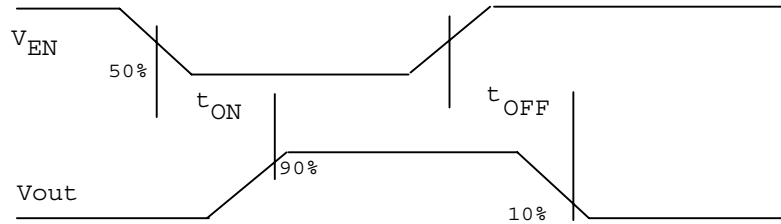

Active-Low Switch Delay Times

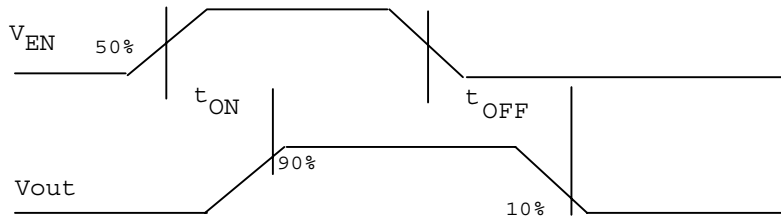

Active-High Switch Delay Times

TYPICAL CHARACTERISTICS (Temp: 25 °C)

Supply On-Current v/s Input Voltage

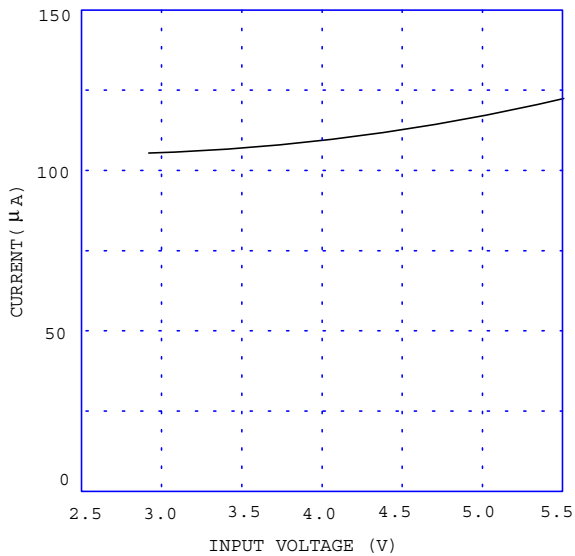

On-Resistance v/s Input Voltage

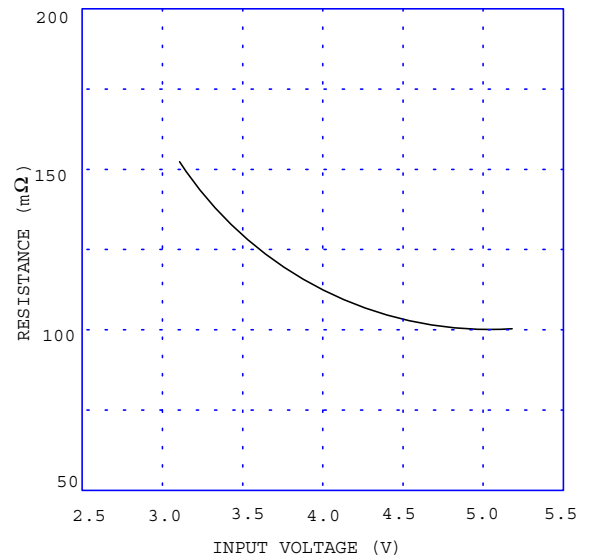

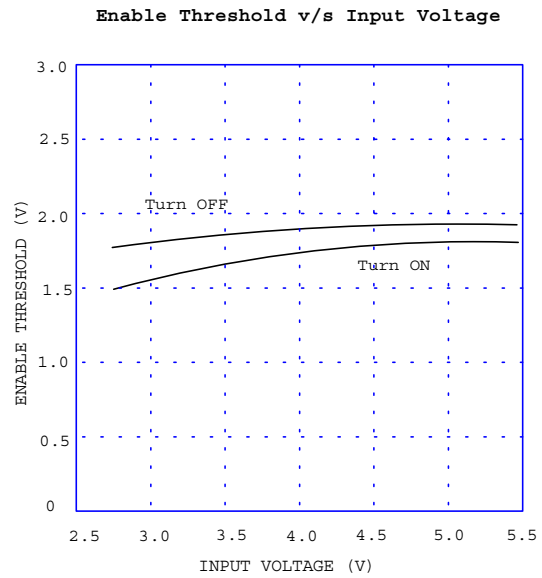
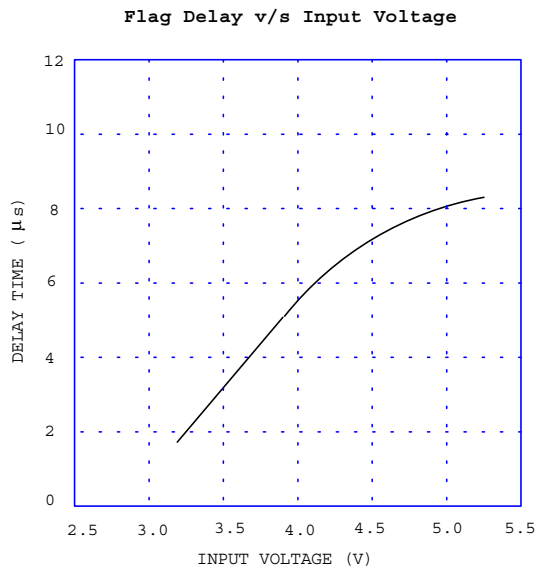

FUNCTIONAL CHARACTERISTICS

Active Low
Enable Input

Error Flag

V_{OUT}

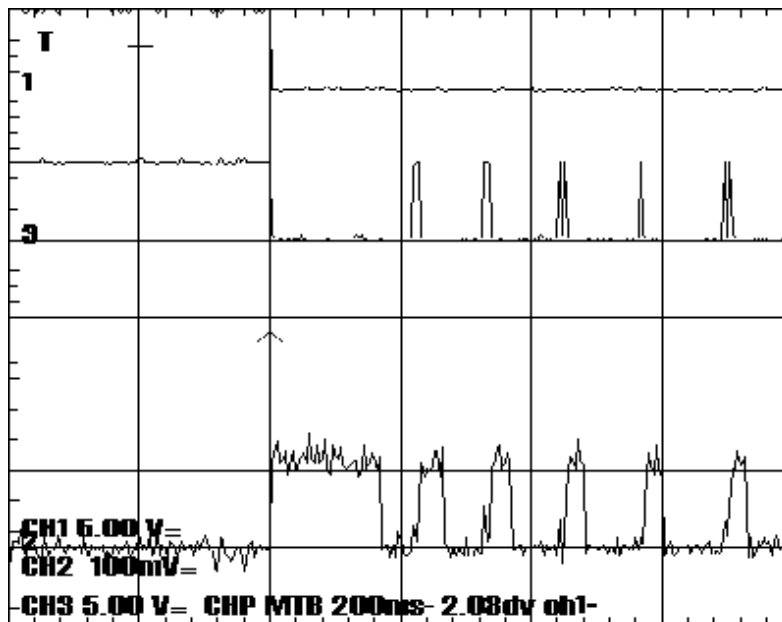

Thermal Shutdown



Active Low
Enable Input

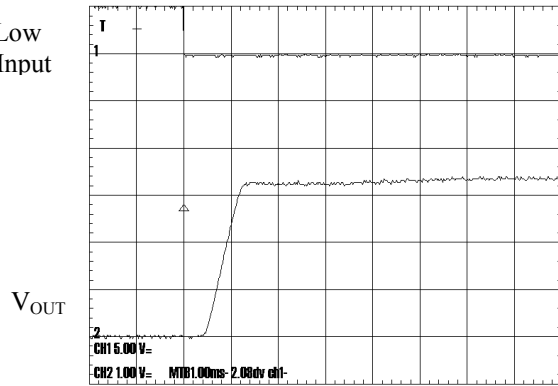

Turn-On with 47 Ω /10 μ F Load

Active Low
Enable Input

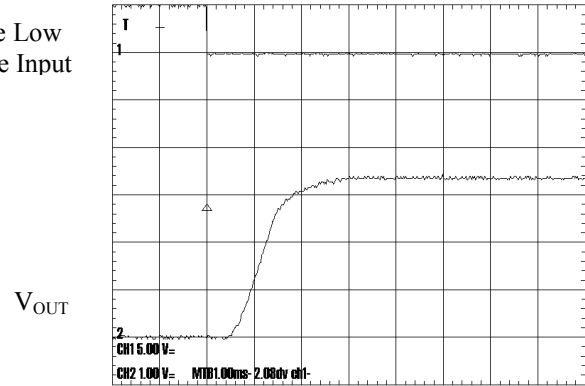

Turn-On with 47 Ω /150 μ F Load

Active Low
Enable Input

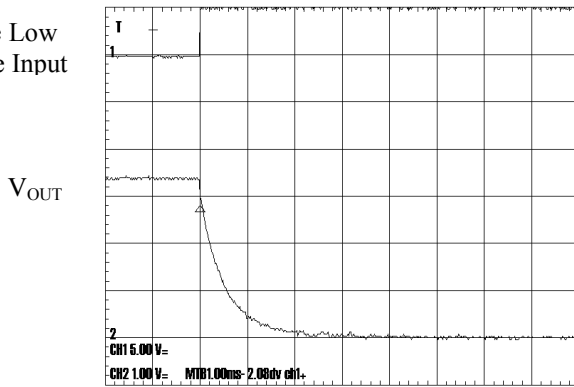

Turn-Off with 47 Ω /10 μ F Load

Active Low
Enable Input

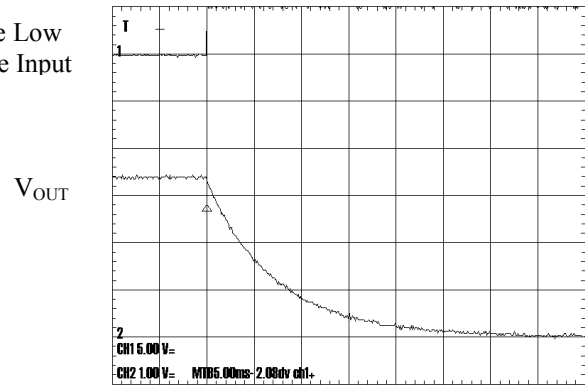

Turn-Off with 47 Ω /10 μ F Load