

Dual N-CHANNEL ENHANCEMENT MODE POWER MOSFET

MTDN9926Q8

BV_{DSS}	20V
I_D	6A
$R_{DSON(MAX)}$	28m Ω

Description

The MTDN9926Q8 provides the designer with the best combination of fast switching, ruggedized device design, low on-resistance and cost effectiveness.

The SOP-8 package is universally preferred for all commercial-industrial surface mount applications and suited for low voltage applications such as DC/DC converters.

Features

- $R_{DS(ON)}=28m\Omega @ V_{GS}=4.5V, I_D=6A$
- Simple drive requirement
- Low on-resistance
- Fast switching speed
- Capable of 2.5V gate drive
- Pb-free lead plating package

Equivalent Circuit

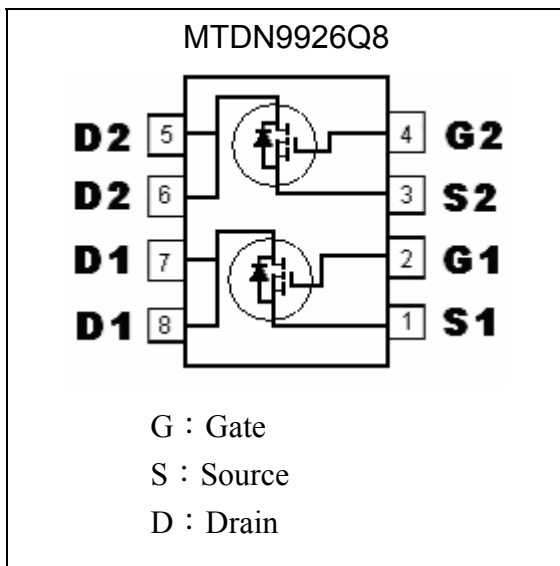

Outline

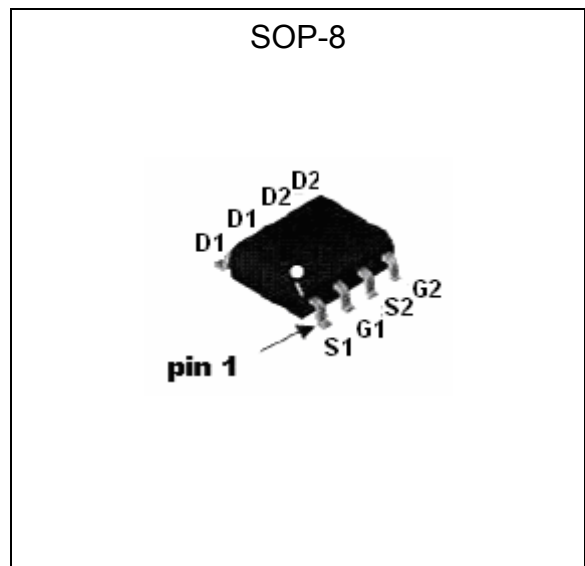

Ordering Information

Device	Package	Shipping	Marking
MTDN9926Q8	SOP-8 (Pb-free package)	3000 pcs / Tape & Reel	9926SS



Absolute Maximum Ratings (Ta=25°C)

Parameter	Symbol	Limits	Unit
Drain-Source Voltage	V _{DS}	20	V
Gate-Source Voltage	V _{GS}	±12	V
Continuous Drain Current @ V _{GS} =4.5V, T _A =25 °C (Note 1)	I _D	6	A
Continuous Drain Current @ V _{GS} =4.5V, T _A =70 °C (Note 1)	I _D	4.8	A
Pulsed Drain Current (Note 2&3)	I _{DM}	20	A
Total Power Dissipation @ T _A =25 °C Linear Derating Factor	P _d	2	W
		0.016	W / °C
Operating Junction and Storage Temperature Range	T _j , T _{stg}	-55~+150	°C
Thermal Resistance, Junction-to-Ambient (Note 1)	R _{th,ja}	62.5	°C/W

Note : 1. Surface mounted on 1 in² copper pad of FR-4 board; 135°C/W when mounted on minimum copper pad
 2. Pulse width limited by maximum junction temperature.
 3. Pulse width ≤ 300µs, duty cycle ≤ 2%

Characteristics (T_j=25°C, unless otherwise specified)

Symbol	Min.	Typ.	Max.	Unit	Test Conditions
Static					
B _V D _{SS}	20	-	-	V	V _{GS} =0, I _D =250µA
ΔB _V D _{SS} /ΔT _j	-	0.03	-	V/°C	Reference to 25°C, I _D =1mA
V _{GS(th)}	0.5	-	1.2	V	V _{DS} = V _{GS} , I _D =250µA
G _{FS}	-	20	-	S	V _{DS} =10V, I _D =6A
I _{GSS}	-	-	±100	nA	V _{GS} =±12V, V _{DS} =0
I _{DSS}	-	-	1	µA	V _{DS} =20V, V _{GS} =0
	-	-	25	µA	V _{DS} =16V, V _{GS} =0, T _j =70°C
*R _{DS(ON)}	-	-	28	mΩ	I _D =6A, V _{GS} =4.5V
	-	-	38		I _D =5.2A, V _{GS} =2.5V
Dynamic					
*Q _g	-	23	-	nC	V _{DS} =20V, I _D =6A, V _{GS} =5V
*Q _{gs}	-	4.5	-		
*Q _{gd}	-	7	-		
*t _{d(ON)}	-	30	-	ns	V _{DS} =10V, I _D =1A, V _{GS} =5V, R _G =6Ω, R _D =10Ω
*t _r	-	70	-		
*t _{d(OFF)}	-	40	-		
*t _f	-	65	-		
C _{iss}	-	1035	-	pF	V _{DS} =20V, V _{GS} =0, f=1MHz
C _{oss}	-	320	-		
C _{rss}	-	150	-		
Source-Drain Diode					
*V _{SD}	-	-	1.2	V	I _S =1.7A, V _{GS} =0V
*I _S	-	-	1.54	A	V _D =V _G =0V, V _S =1.3V

*Pulse Test : Pulse Width ≤ 300µs, Duty Cycle ≤ 2%

Characteristic Curves

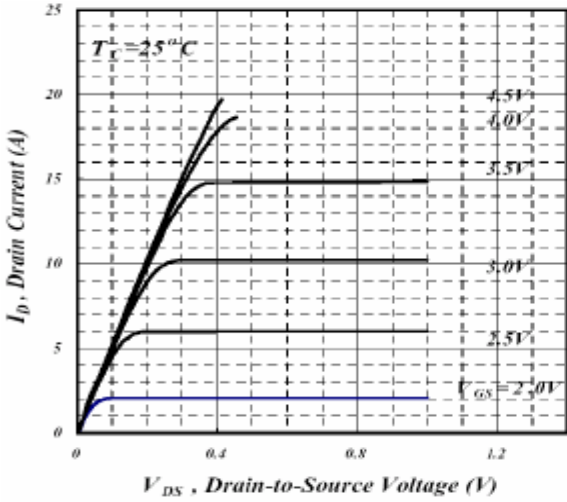

Fig 1. Typical Output Characteristics

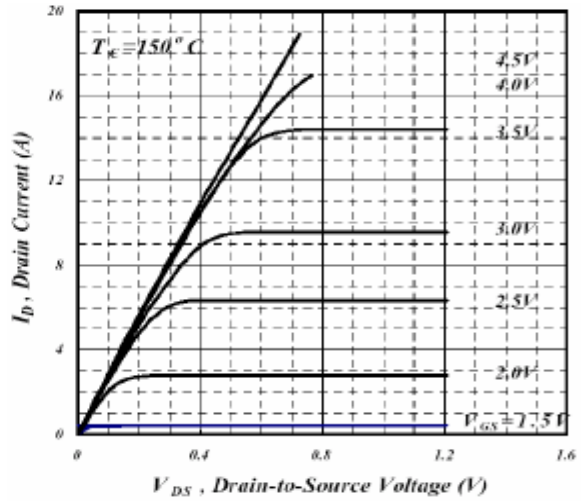

Fig 2. Typical Output Characteristics

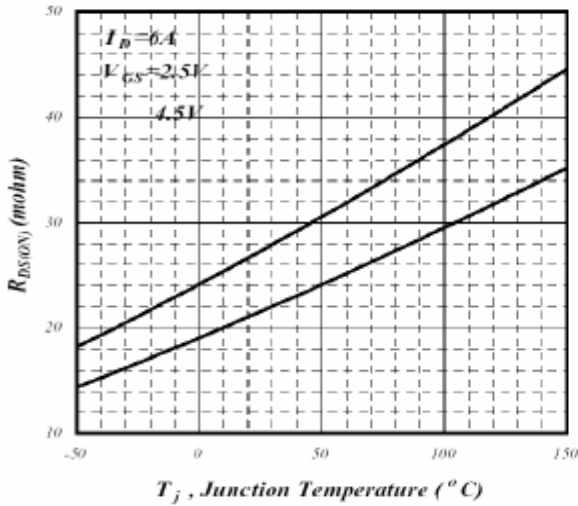

Fig 3. RDSON v.s. Junction Temperature

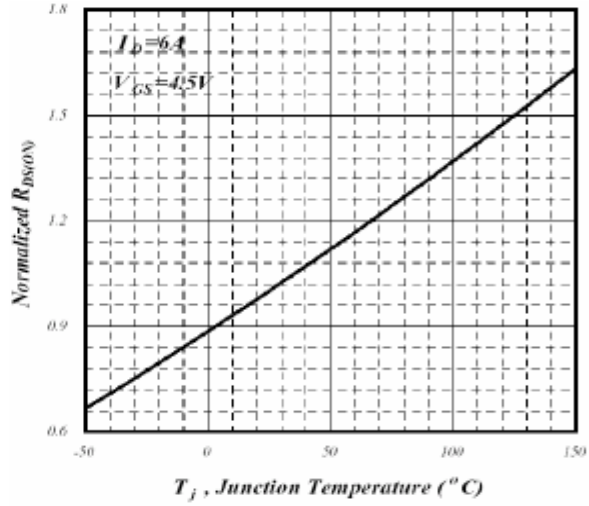

Fig 4. Normalized On-Resistance v.s. Junction Temperature

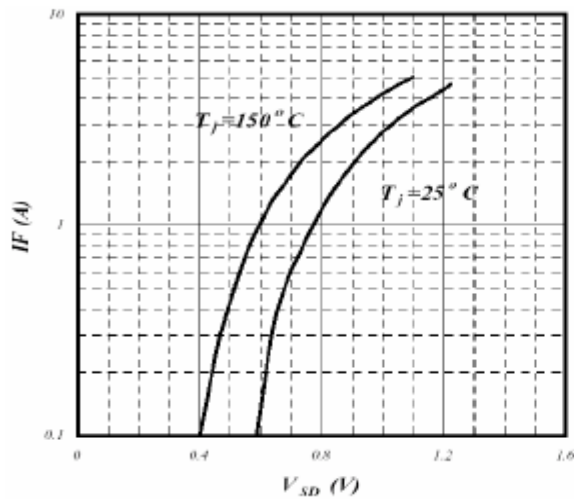

Fig 5. Forward Characteristics of Reverse Diode

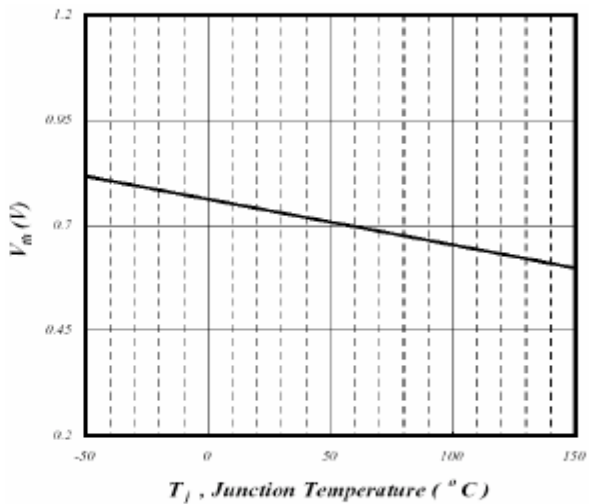

Fig 6. Gate Threshold Voltage v.s. Junction Temperature

Characteristic Curves(Cont.)

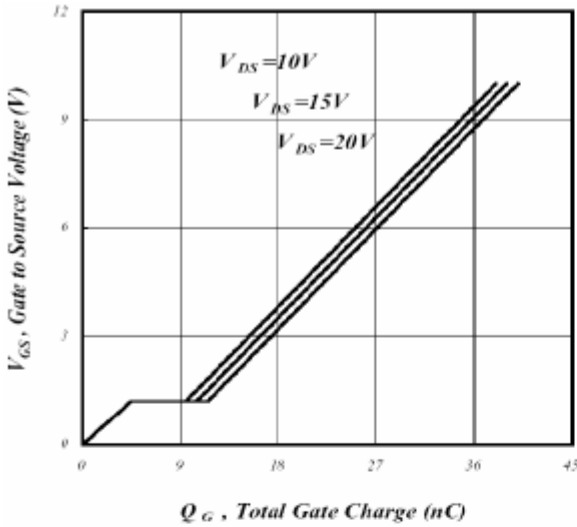

Fig 7. Gate Charge Characteristics

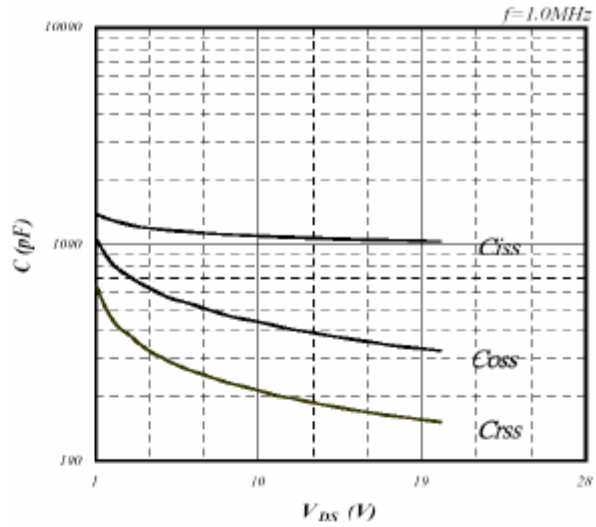

Fig 8. Typical Capacitance Characteristics

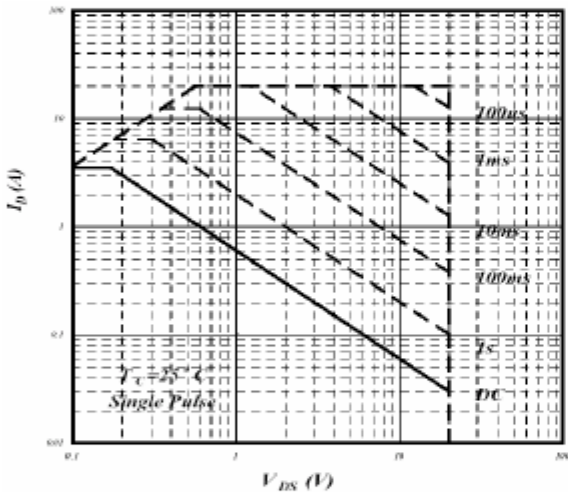

Fig 9. Maximum Safe Operating Area

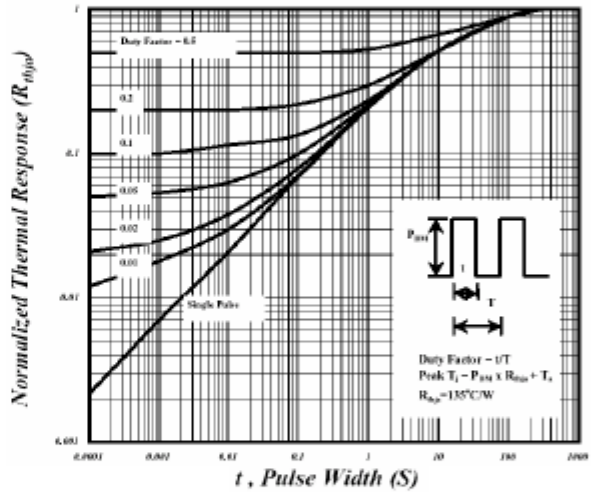

Fig 10. Effective Transient Thermal Impedance

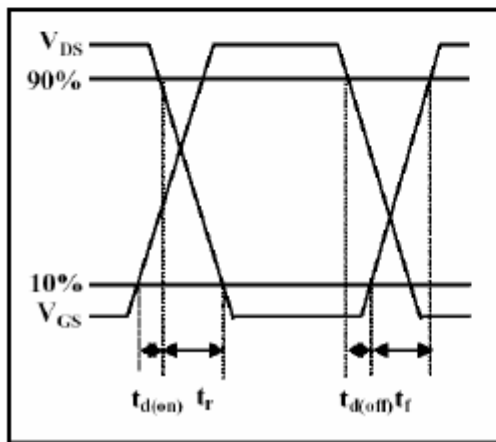

Fig 11. Switching Time Waveform

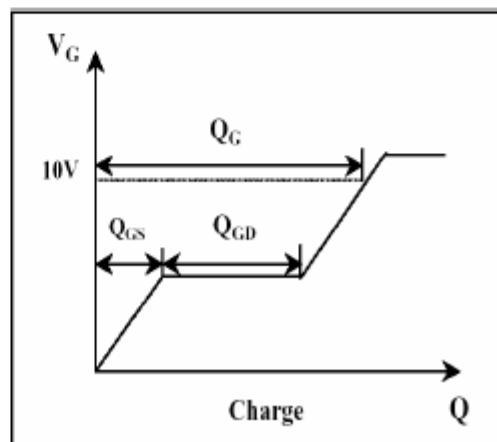
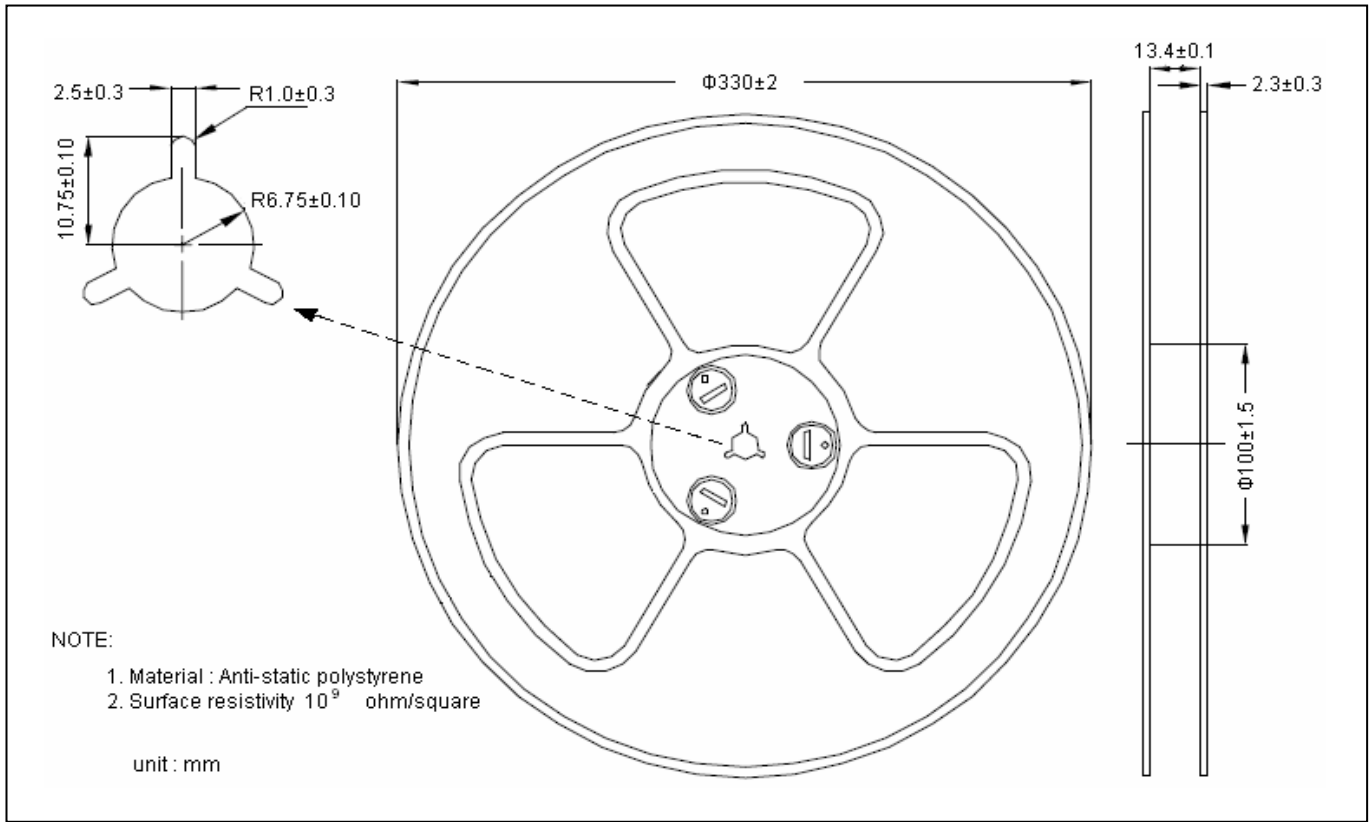
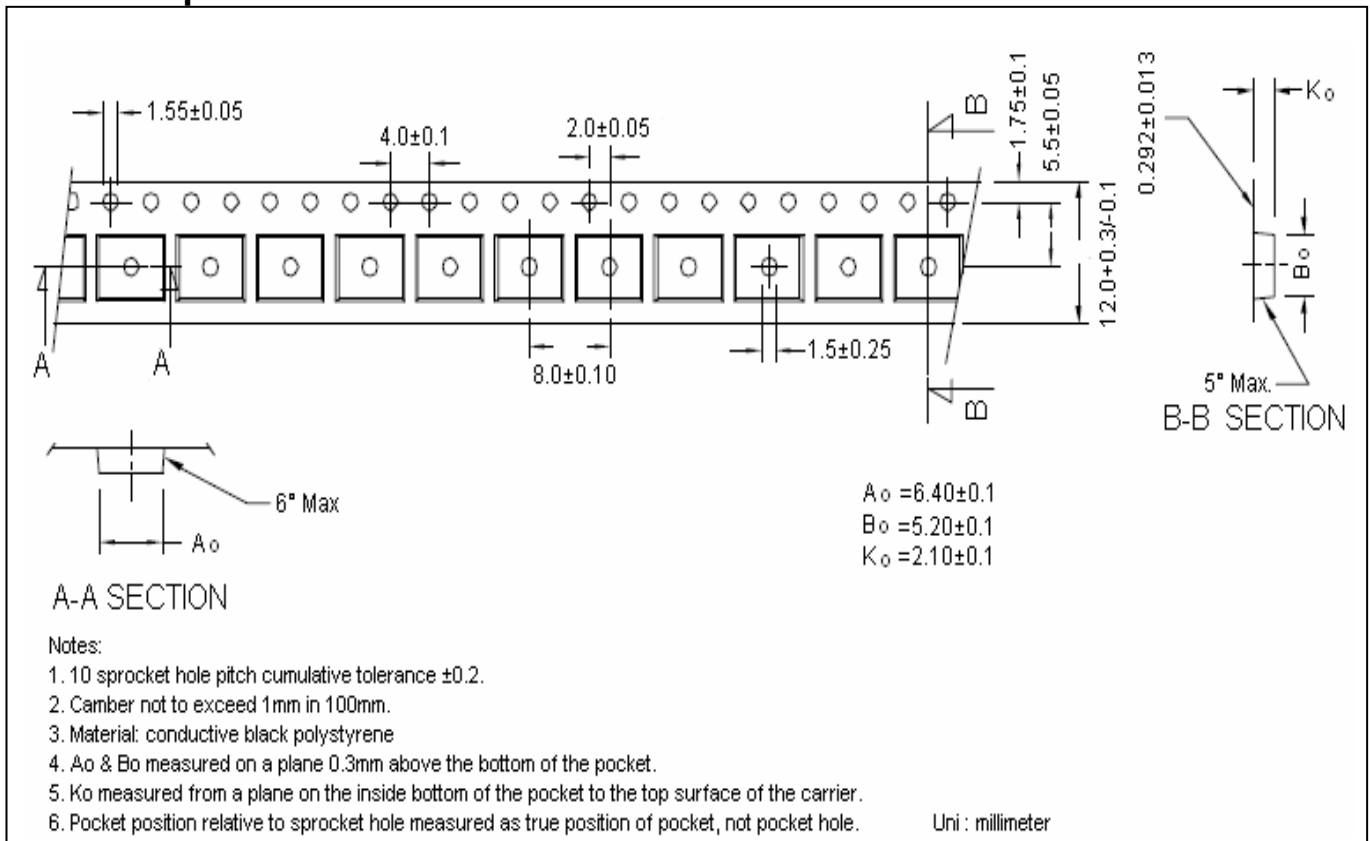

Fig 12. Gate Charge Waveform

Reel Dimension



Carrier Tape Dimension



Recommended wave soldering condition

Product	Peak Temperature	Soldering Time
Pb-free devices	260 +0/-5 °C	5 +1/-1 seconds

Recommended temperature profile for IR reflow

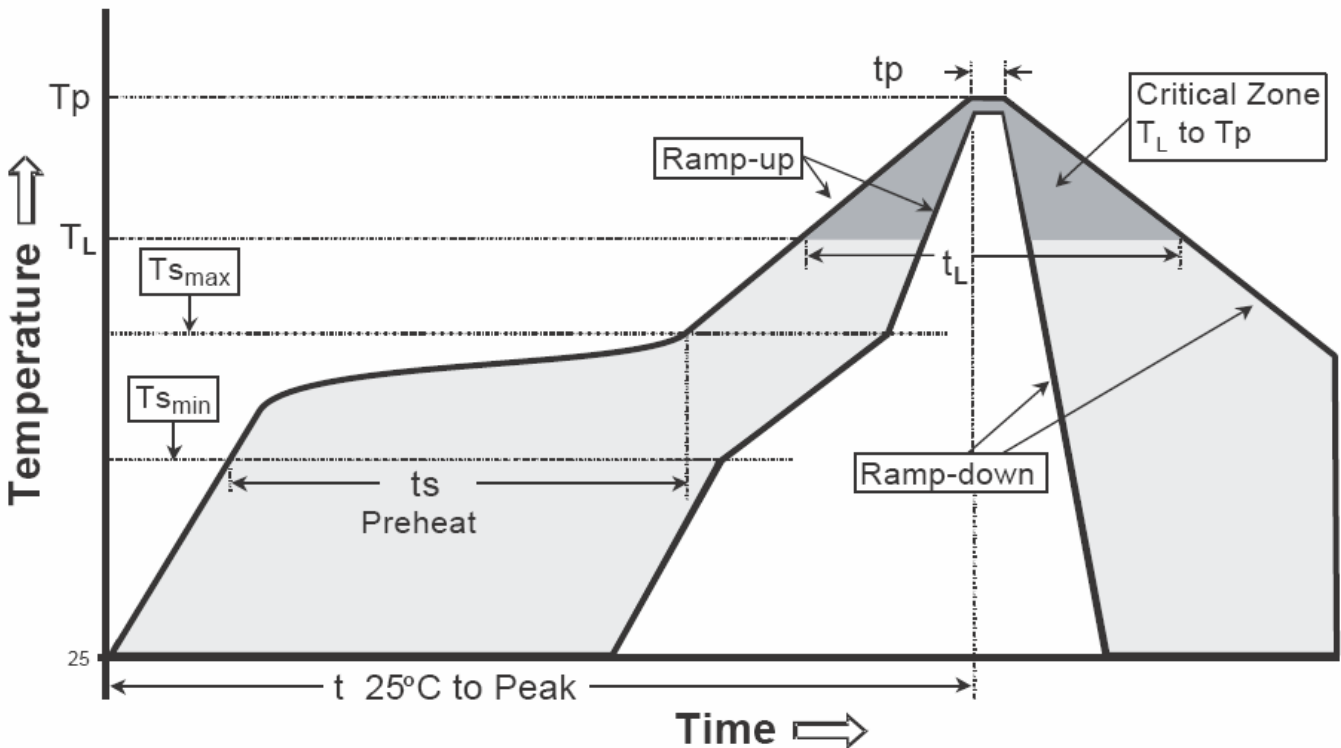

Profile feature	Sn-Pb eutectic Assembly	Pb-free Assembly
Average ramp-up rate (Tsmax to Tp)	3°C/second max.	3°C/second max.
Preheat		
-Temperature Min(Ts min)	100°C	150°C
-Temperature Max(Ts max)	150°C	200°C
-Time(ts min to ts max)	60-120 seconds	60-180 seconds
Time maintained above:		
-Temperature (TL)	183°C	217°C
- Time (tL)	60-150 seconds	60-150 seconds
Peak Temperature(TP)	240 +0/-5 °C	260 +0/-5 °C
Time within 5°C of actual peak temperature(tp)	10-30 seconds	20-40 seconds
Ramp down rate	6°C/second max.	6°C/second max.
Time 25 °C to peak temperature	6 minutes max.	8 minutes max.

Note : All temperatures refer to topside of the package, measured on the package body surface.

SOP-8 Dimension

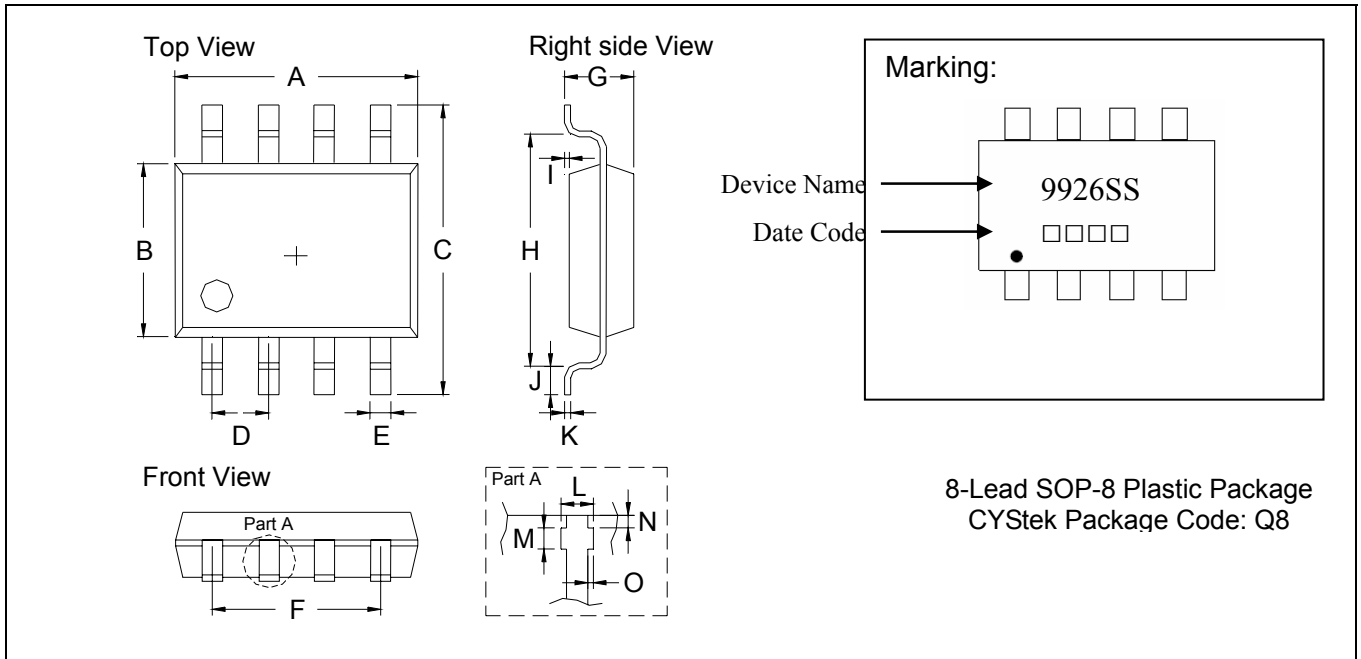

*: Typical

DIM	Inches		Millimeters		DIM	Inches		Millimeters	
	Min.	Max.	Min.	Max.		Min.	Max.	Min.	Max.
A	0.1890	0.2007	4.80	5.10	I	0.0098	REF	0.25	REF
B	0.1496	0.1654	3.80	4.20	J	0.0118	0.0354	0.30	0.90
C	0.2283	0.2441	5.80	6.20	K	0.0074	0.0098	0.19	0.25
D	0.0480	0.0519	1.22	1.32	L	0.0145	0.0204	0.37	0.52
E	0.0138	0.0193	0.35	0.49	M	0.0118	0.0197	0.30	0.50
F	0.1472	0.1527	3.74	3.88	N	0.0031	0.0051	0.08	0.13
G	0.0531	0.0689	1.35	1.75	O	0.0000	0.0059	0.00	0.15
H	0.1889	0.2007	4.80	5.10					

- Notes: 1. Controlling dimension: millimeters.
 2. Maximum lead thickness includes lead finish thickness, and minimum lead thickness is the minimum thickness of base material.
 3. If there is any question with packing specification or packing method, please contact your local CYStek sales office.

Material:

- Leads: Pure tin plated.
- Mold Compound: Epoxy resin family, flammability solid burning class: UL94V-0.

Important Notice:

- All rights are reserved. Reproduction in whole or in part is prohibited without the prior written approval of CYStek.
- CYStek reserves the right to make changes to its products without notice.
- CYStek **semiconductor products are not warranted to be suitable for use in Life-Support Applications, or systems.**
- CYStek assumes no liability for any consequence of customer product design, infringement of patents, or application assistance.