



Is Now Part of



ON Semiconductor®

To learn more about ON Semiconductor, please visit our website at
www.onsemi.com

Please note: As part of the Fairchild Semiconductor integration, some of the Fairchild orderable part numbers will need to change in order to meet ON Semiconductor's system requirements. Since the ON Semiconductor product management systems do not have the ability to manage part nomenclature that utilizes an underscore (_), the underscore (_) in the Fairchild part numbers will be changed to a dash (-). This document may contain device numbers with an underscore (_). Please check the ON Semiconductor website to verify the updated device numbers. The most current and up-to-date ordering information can be found at www.onsemi.com. Please email any questions regarding the system integration to Fairchild_questions@onsemi.com.

ON Semiconductor and the ON Semiconductor logo are trademarks of Semiconductor Components Industries, LLC dba ON Semiconductor or its subsidiaries in the United States and/or other countries. ON Semiconductor owns the rights to a number of patents, trademarks, copyrights, trade secrets, and other intellectual property. A listing of ON Semiconductor's product/patent coverage may be accessed at www.onsemi.com/site/pdf/Patent-Marking.pdf. ON Semiconductor reserves the right to make changes without further notice to any products herein. ON Semiconductor makes no warranty, representation or guarantee regarding the suitability of its products for any particular purpose, nor does ON Semiconductor assume any liability arising out of the application or use of any product or circuit, and specifically disclaims any and all liability, including without limitation special, consequential or incidental damages. Buyer is responsible for its products and applications using ON Semiconductor products, including compliance with all laws, regulations and safety requirements or standards, regardless of any support or applications information provided by ON Semiconductor. "Typical" parameters which may be provided in ON Semiconductor data sheets and/or specifications can and do vary in different applications and actual performance may vary over time. All operating parameters, including "Typicals" must be validated for each customer application by customer's technical experts. ON Semiconductor does not convey any license under its patent rights nor the rights of others. ON Semiconductor products are not designed, intended, or authorized for use as a critical component in life support systems or any FDA Class 3 medical devices or medical devices with a same or similar classification in a foreign jurisdiction or any devices intended for implantation in the human body. Should Buyer purchase or use ON Semiconductor products for any such unintended or unauthorized application, Buyer shall indemnify and hold ON Semiconductor and its officers, employees, subsidiaries, affiliates, and distributors harmless against all claims, costs, damages, and expenses, and reasonable attorney fees arising out of, directly or indirectly, any claim of personal injury or death associated with such unintended or unauthorized use, even if such claim alleges that ON Semiconductor was negligent regarding the design or manufacture of the part. ON Semiconductor is an Equal Opportunity/Affirmative Action Employer. This literature is subject to all applicable copyright laws and is not for resale in any manner.



FL73282 Half-Bridge Gate Driver

Features

- Floating Channel for Bootstrap Operation to +900 V
- Typically 350 mA / 650 mA Sourcing/Sinking Current Driving Capability for Both Channels
- Common-Mode dv/dt Noise Canceling Circuit
- Extended Allowable Negative V_S Swing to -9.8 V for Signal Propagation at $V_{CC}=V_{BS}=15$ V
- V_{CC} & V_{BS} Supply Range from 10 V to 20 V
- UVLO Functions for Both Channels
- Matched Propagation Delay Below 50 ns
- Built-in 170 ns Dead-Time
- Output in Phase with Input Signal

Description

The FL73282, a monolithic half bridge gate-drive IC, can drive MOSFETs and IGBTs that operate up to +900 V. Fairchild's high-voltage process and common mode noise canceling technique provides stable operation of the high-side driver under high-dV_S/dt noise circumstances. An advanced level-shift circuit allows high-side gate driver operation up to $V_S=-9.8$ V (typical) for $V_{BS}=15$ V. The UVLO circuits for both channels prevent malfunction when V_{CC} or V_{BS} is lower than the specified threshold voltage. Output drivers typically source/sink 350 mA / 650 mA, respectively, which is suitable for all kinds of half- and full-bridge inverters.



Figure 1. SOP 8

Applications

- Fluorescent Lamp Ballast
- HID Ballast
- SMPS
- Motor Driver
- General Purpose Half Bridge Topology

Ordering Information

Part Number	Operating Temperature Range	Package	Packing Method
FL73282MX ⁽¹⁾	-40°C to +125°C	8-Lead, Small Outline Integrated Circuit, (SOIC)	Tape & Reel

Note:

1. These devices passed wave-soldering test by JESD22A-111.

Typical Application Diagram

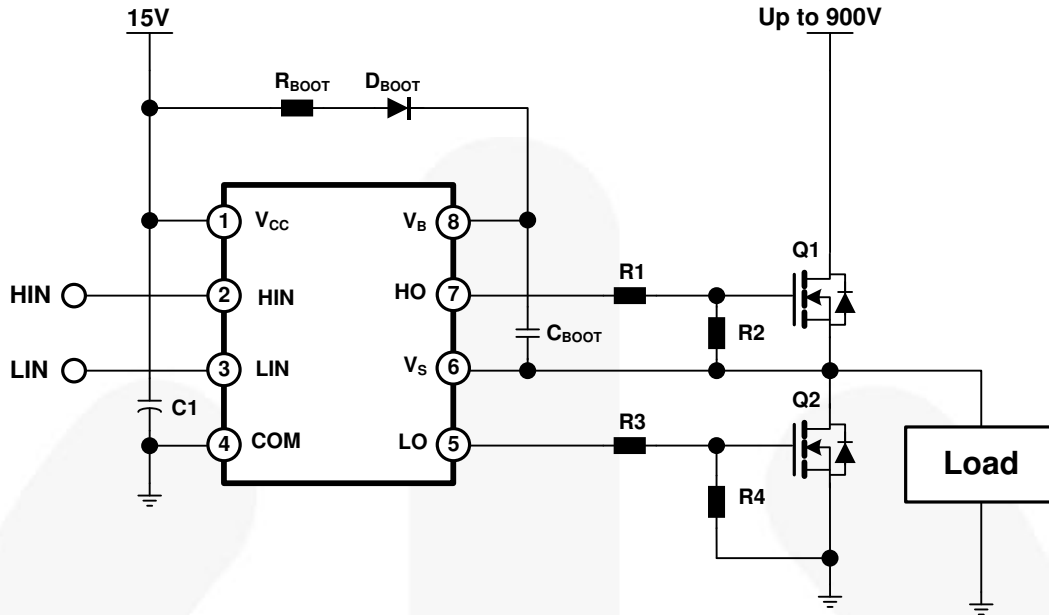

Figure 2. Application Circuit for Half Bridge Topology

Internal Block Diagram

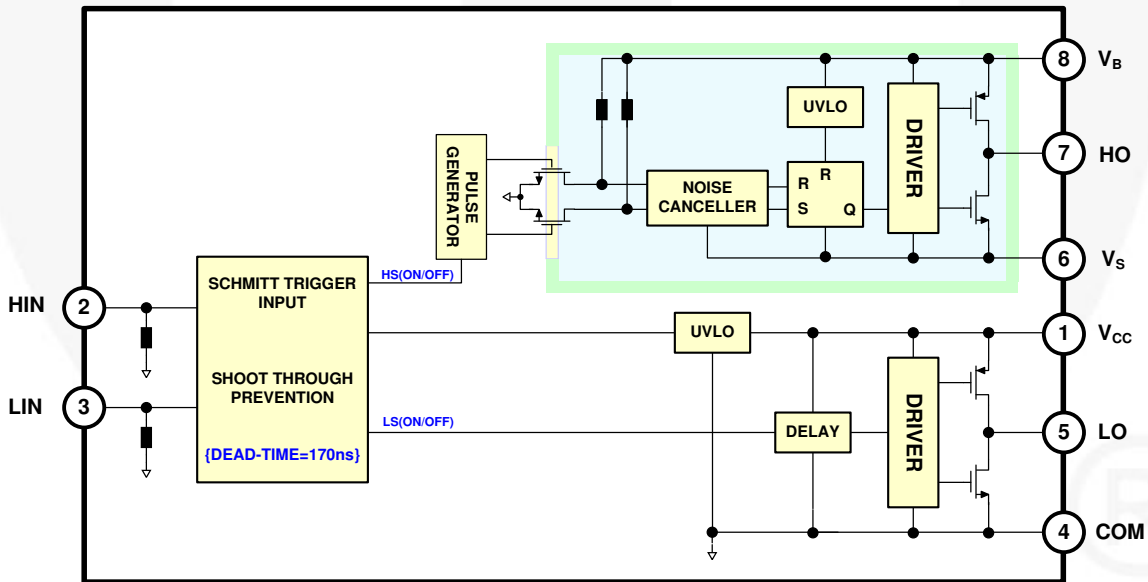

Figure 3. Functional Block Diagram

Pin Configuration

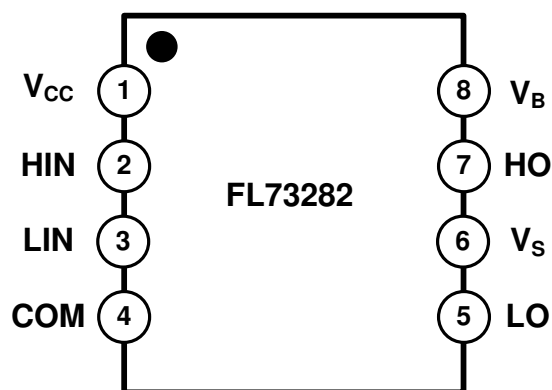

Figure 4. Pin Assignments (Top View)

Pin Definitions

Pin	Name	I/O	Description
1	V _{CC}	I	Low-Side Supply Voltage
2	HIN	I	Logic Input for High-Side Gate Driver Output
3	LIN	I	Logic Input for Low-Side Gate Driver Output
4	COM		Logic Ground and Low-Side Driver Return
5	LO	O	Low-Side Driver Output
6	V _S	I	High-Voltage Floating Supply Return
7	HO	O	High-Side Driver Output
8	V _B	I	High-Side Floating Supply

Absolute Maximum Ratings

Stresses exceeding the Absolute Maximum Ratings may damage the device. The device may not function or be operable above the recommended operating conditions and stressing the parts to these levels is not recommended. In addition, extended exposure to stresses above the recommended operating conditions may affect device reliability. The absolute maximum ratings are stress ratings only.

Symbol	Parameter	Min.	Max.	Unit
V_S	High-Side Floating Offset Voltage	V_B-24	$V_B+0.3$	V
V_B	High-Side Floating Supply Voltage	-0.3	924.0	V
V_{CC}	Low-Side and Logic-Fixed Supply Voltage	-0.3	24	V
V_{HO}	High-Side Floating Output Voltage V_{HO}	$V_S-0.3$	$V_B+0.3$	V
V_{LO}	Low-Side Floating Output Voltage V_{LO}	-0.3	$V_{CC}+0.3$	V
V_{IN}	Logic Input Voltage (HIN, LIN)	-0.3	$V_{CC}+0.3$	V
COM	Logic Ground	$V_{CC}-24$	$V_{CC}+0.3$	V
dV_S/dt	Allowable Offset Voltage Slew Rate		± 50	V/ns
$P_D^{(3)(4)(5)}$	Power Dissipation		0.625	W
θ_{JA}	Thermal Resistance		200	$^{\circ}\text{C}/\text{W}$
T_J	Junction Temperature		150	$^{\circ}\text{C}$
T_{STG}	Storage Temperature	-55	150	$^{\circ}\text{C}$

Notes:

- Mounted on 76.2 x 114.3 x 1.6 mm PCB (FR-4 glass epoxy material).
- Refer to the following standards:
JESD51-2: Integral circuit's thermal test method environmental conditions, natural convection;
JESD51-3: Low effective thermal conductivity test board for leaded surface-mount packages.
- Do not exceed maximum power dissipation (P_D) under any circumstances.

Recommended Operating Conditions

The Recommended Operating Conditions table defines the conditions for actual device operation. Recommended operating conditions are specified to ensure optimal performance to the datasheet specifications. Fairchild does not recommend exceeding them or designing to Absolute Maximum Ratings.

Symbol	Parameter	Min.	Max.	Unit
V_B	High-Side Floating Supply Voltage	V_S+10	V_S+20	V
V_S	High-Side Floating Supply Offset Voltage	$6-V_{CC}$	900	V
V_{HO}	High-Side (HO) Output Voltage	V_S	V_B	V
V_{LO}	Low-Side (LO) Output Voltage	COM	V_{CC}	V
V_{IN}	Logic Input Voltage (HIN, LIN)	COM	V_{CC}	V
V_{CC}	Low-Side Supply Voltage	10	20	V
T_A	Ambient Temperature	-40	+125	$^{\circ}\text{C}$

Static Electrical Characteristics

$V_{BIAS}(V_{CC}, V_{BS}) = 15.0\text{ V}$, $T_A = 25^\circ\text{C}$, unless otherwise specified. The V_{IN} and I_{IN} parameters are referenced to COM. The V_O and I_O parameters are referenced to V_S and COM and are applicable to the respective outputs HO and LO.

Symbol	Parameter	Condition	Min.	Typ.	Max.	Unit
Power Supply Section						
I_{QCC}	Quiescent V_{CC} Supply Current	$V_{IN}=0\text{ V or }5\text{ V}$		80	180	μA
I_{QBS}	Quiescent V_{BS} Supply Current	$V_{IN}=0\text{ V or }5\text{ V}$		50	120	μA
I_{PCC}	Operating V_{CC} Supply Current	$f_{IN}=20\text{ kHz, rms value}$			550	μA
I_{PBS}	Operating V_{BS} Supply Current	$f_{IN}=20\text{ kHz, rms value}$			600	μA
I_{LK}	Offset Supply Leakage Current	$V_B=V_S=900\text{ V}$			10	μA
Bootstrapped Supply Section						
V_{CCUV+} V_{BSUV+}	V_{CC} & V_{BS} Supply Under-Voltage Positive going Threshold		8.2	9.2	10.0	V
V_{CCUV-} V_{BSUV-}	V_{CC} & V_{BS} Supply Under-Voltage Negative going Threshold		7.6	8.7	9.6	V
V_{CCUVH} V_{BSUVH}	V_{CC} Supply Under-Voltage Lockout Hysteresis			0.5		V
Input Section						
V_{IH}	Logic "1" Input Voltage		2.5			V
V_{IL}	Logic "0" Input Voltage				0.8	V
I_{IN+}	Logic "1" Input Bias Current	$V_{IN}=5\text{ V}$		20	50	μA
I_{IN-}	Logic "0" Input Bias Current	$V_{IN}=0\text{ V}$		1.0	2.0	μA
R_{IN}	Logic Input Pull-Down Resistance		100	250		$\text{K}\Omega$
Gate Driver Output Section						
V_{OH}	High-Level Output Voltage, $V_{BIAS}-V_O$	$I_O=0\text{ A}$			85	mV
V_{OL}	Low-Level Output Voltage, V_O	$I_O=0\text{ A}$			85	mV
I_{O+}	Output HIGH Short-Circuit Pulsed Current	$V_O=0\text{ V}, V_{IN}=5\text{ V}$ with $PW \leq 10\ \mu\text{s}$	250	350		mA
I_{O-}	Output LOW Short-Circuit Pulsed Current	$V_O=15\text{ V}, V_{IN}=0\text{ V}$ with $PW \leq 10\ \mu\text{s}$	500	650		mA
V_S	Allowable Negative V_S Pin Voltage for HIN Signal Propagation to HO			-9.8	-7.0	V

Dynamic Electrical Characteristics

$V_{BIAS}(V_{CC}, V_{BS}) = 15.0\text{ V}$, $V_S = \text{COM}$, $C_L = 1000\text{ pF}$ and $T_A = 25^\circ\text{C}$, unless otherwise specified..

Symbol	Parameter	Conditions	Min.	Typ.	Max.	Unit
t_{ON}	Turn-On Propagation Delay	$V_S=0\text{ V}$	80	150	220	ns
t_{OFF}	Turn-Off Propagation Delay	$V_S=0\text{ V}$ or $900\text{ V}^{(5)}$	80	150	220	ns
t_R	Turn-On Rise Time	$V_{LIN}=V_{HIN}=5\text{ V}$		60	140	ns
t_F	Turn-Off Fall Time	$V_{LIN}=V_{HIN}=0\text{ V}$		30	80	ns
DT	Dead Time		70	170	270	ns
MT	Delay Matching, HS & LS Turn-on/off				50	ns
t_{PW}	Minimum Input Pulse Width that changes the Output ⁽⁵⁾⁽⁶⁾				220	ns

Notes:

5. These parameters are guaranteed by design.
6. The minimum input pulse width time included dead time

Typical Characteristics

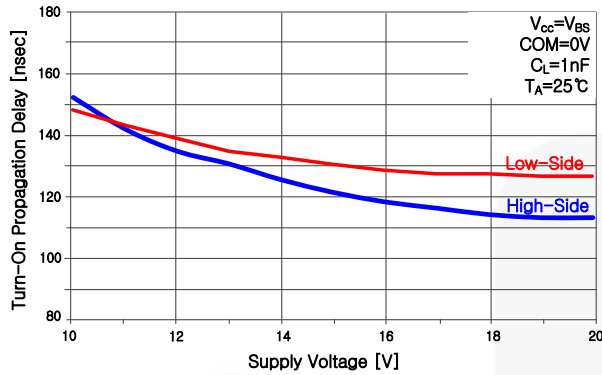

Figure 5. Turn-On Propagation Delay vs. Supply Voltage

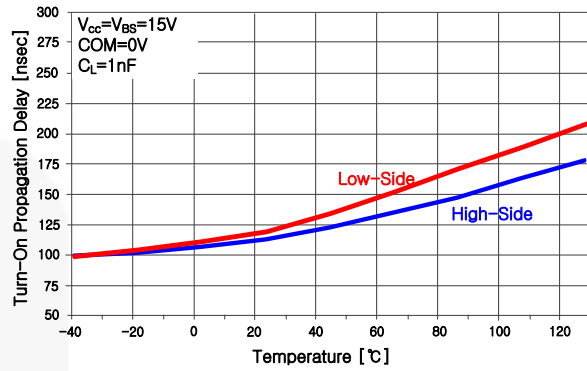

Figure 6. Turn-On Propagation Delay vs. Temperature

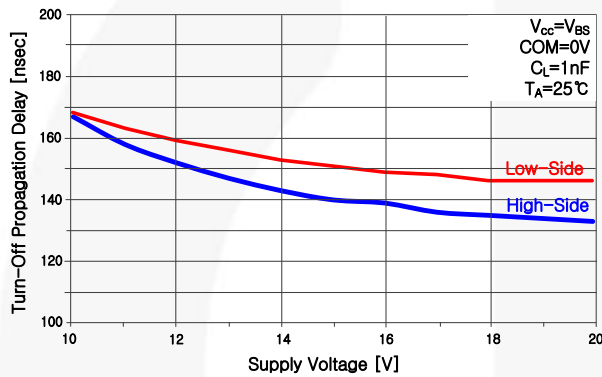

Figure 7. Turn-Off Propagation Delay vs. Supply Voltage

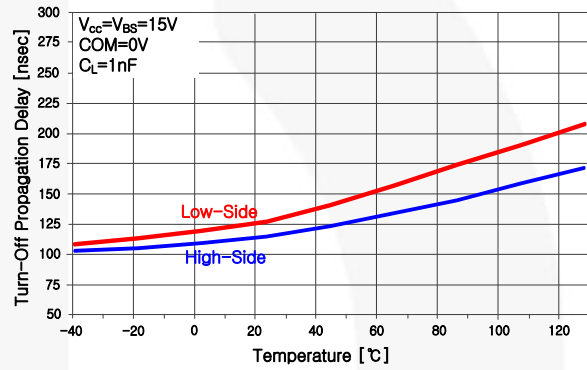

Figure 8. Turn-Off Propagation Delay vs. Temperature

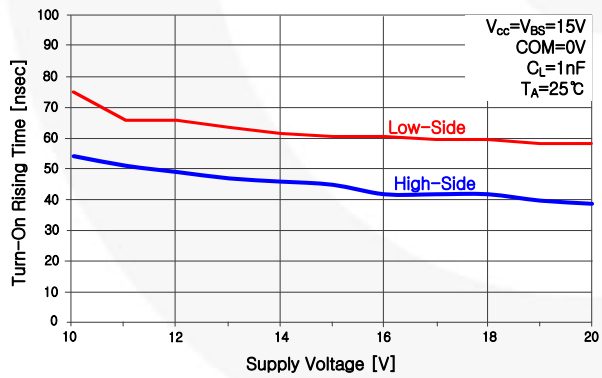

Figure 9. Turn-On Rising Time vs. Supply Voltage

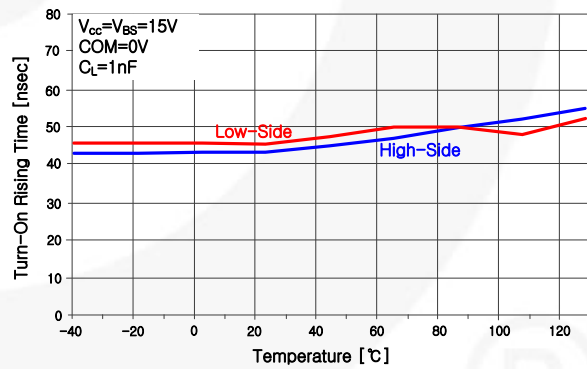

Figure 10. Turn-On Rising Time vs. Temperature

Typical Characteristics (Continued)

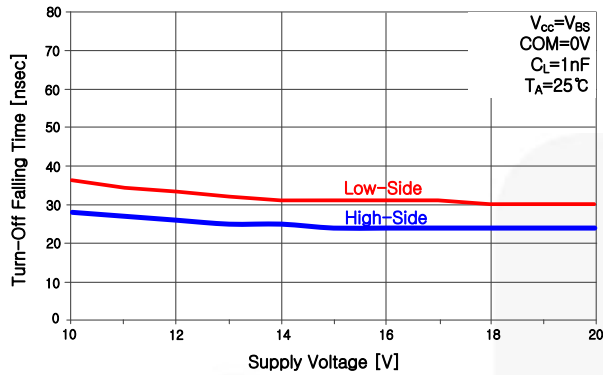

Figure 11. Turn-Off Falling Time vs. Supply Voltage

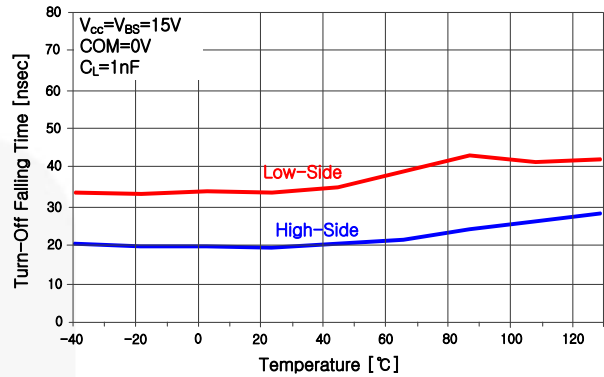

Figure 12. Turn-Off Falling vs. Temperature

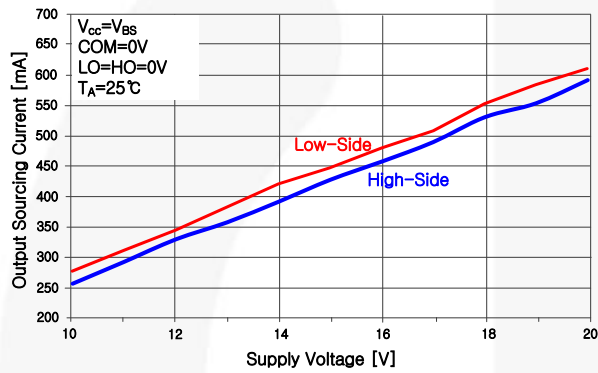

Figure 13. Output Sourcing Current vs. Supply Voltage

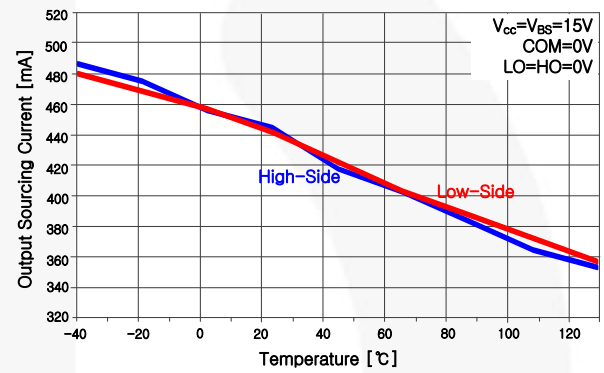

Figure 14. Output Sourcing Current vs. Temperature

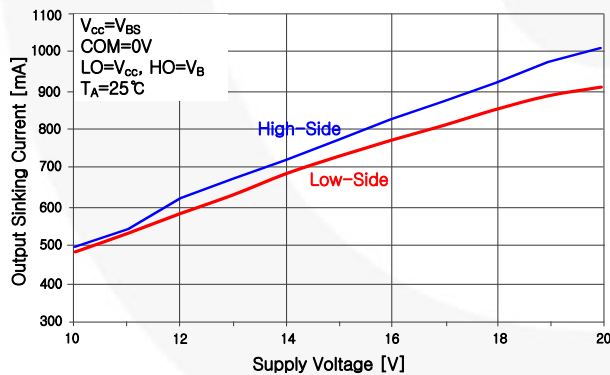

Figure 15. Output Sinking Current vs. Supply Voltage

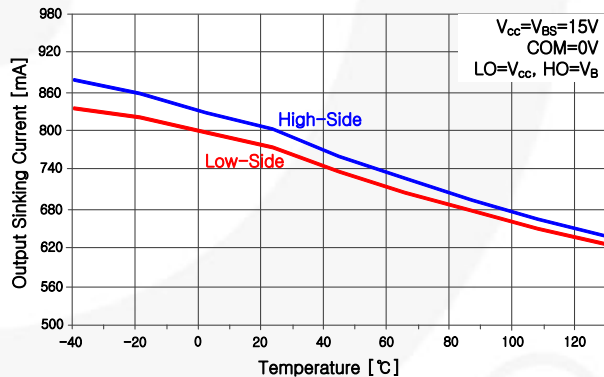

Figure 16. Output Sinking Current vs. Temperature

Typical Characteristics (Continued)

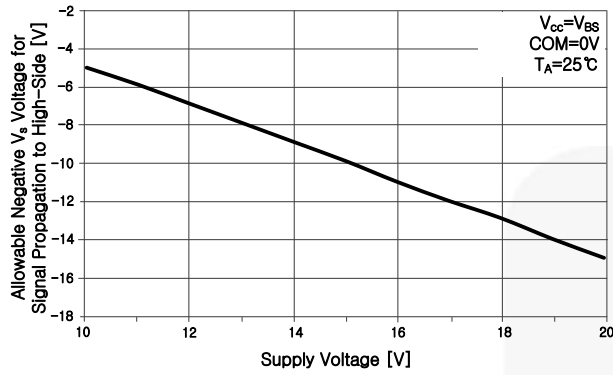

Figure 17. Allowable Negative V_S Voltage for Signal Propagation to High Side vs. Supply Voltage

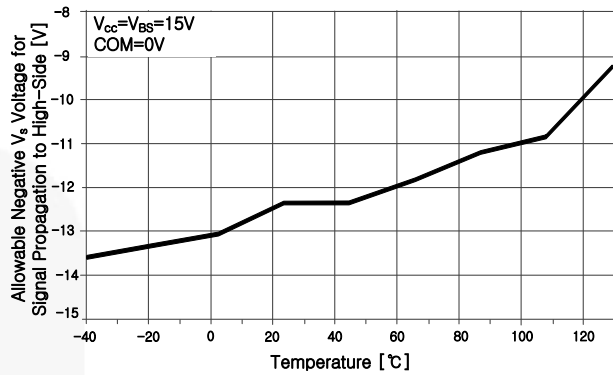

Figure 18. Allowable Negative V_S Voltage for Signal Propagation to High Side vs. Temperature

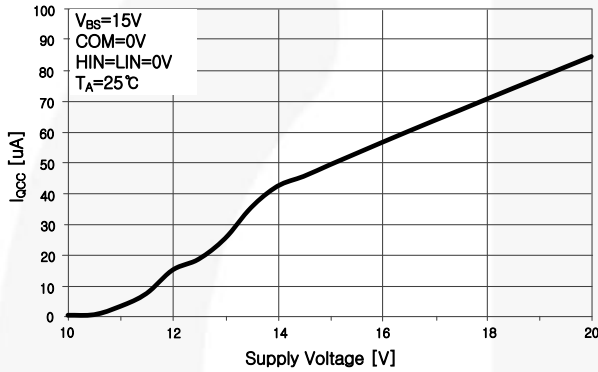

Figure 19. I_{QCC} vs. Supply Voltage

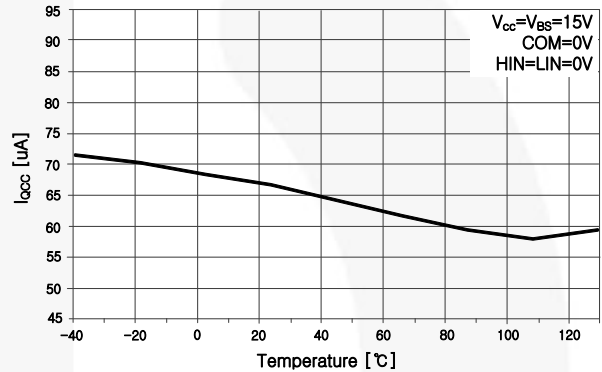

Figure 20. I_{QCC} vs. Temperature

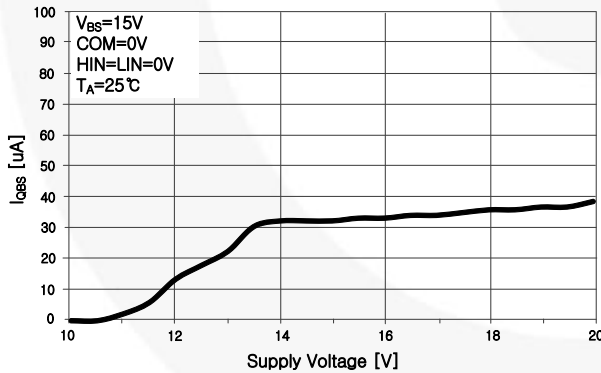

Figure 21. I_{QBS} vs. Supply Voltage

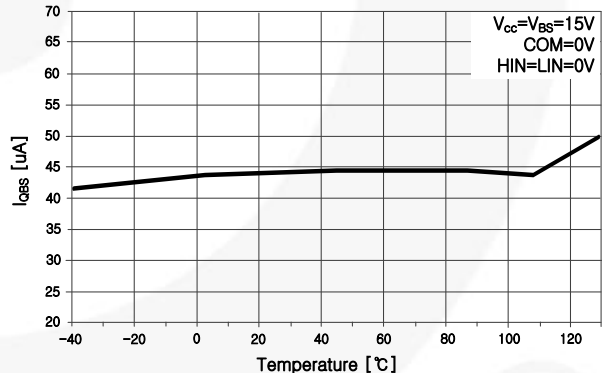

Figure 22. I_{QBS} vs. Temperature

Typical Characteristics (Continued)

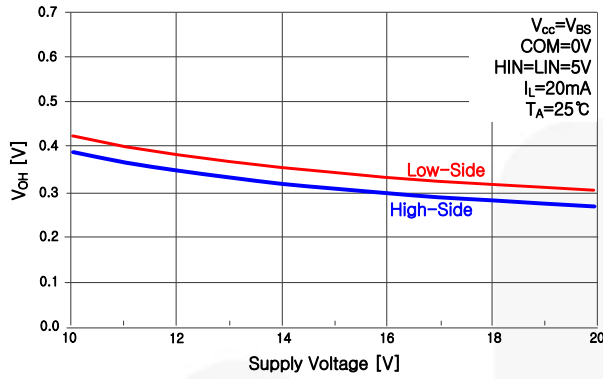

Figure 23. High-Level Output Voltage vs. Supply Voltage

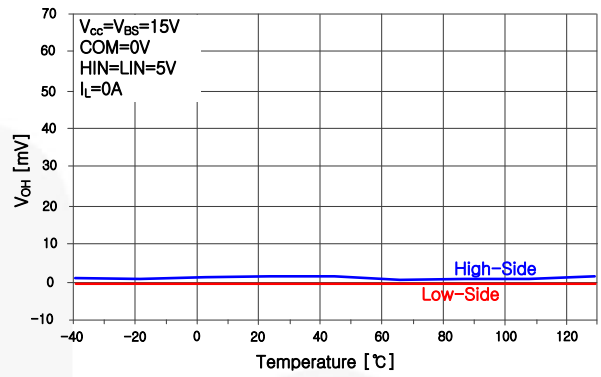

Figure 24. High-Level Output Voltage vs. Temperature

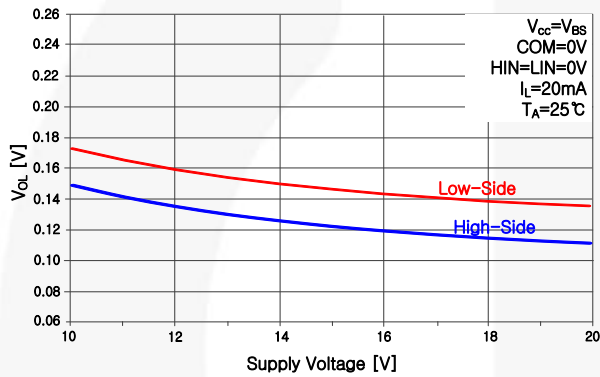

Figure 25. Low-Level Output Voltage vs. Supply Voltage

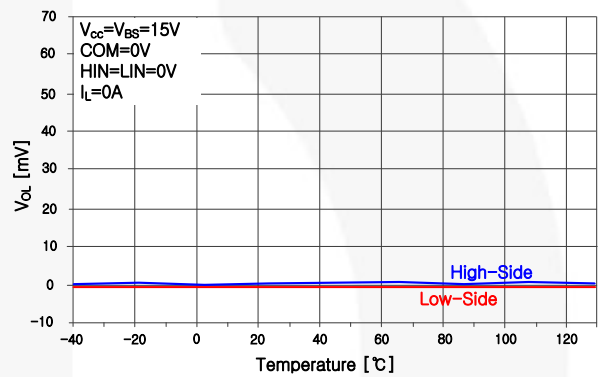

Figure 26. Low-Level Output Voltage vs. Temperature

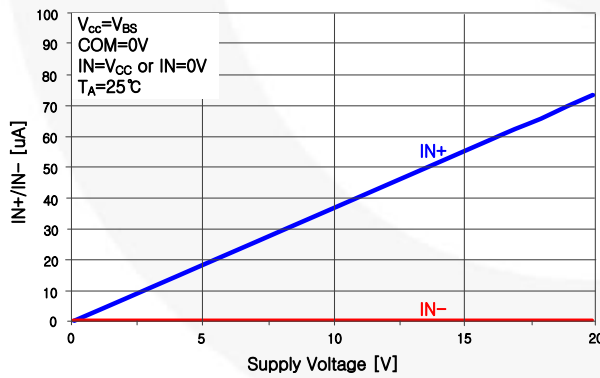

Figure 27. Input Bias Current vs. Supply Voltage

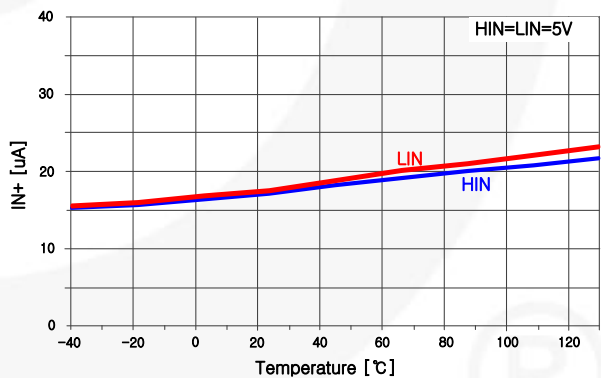

Figure 28. Input Bias Current vs. Temperature

Typical Characteristics (Continued)

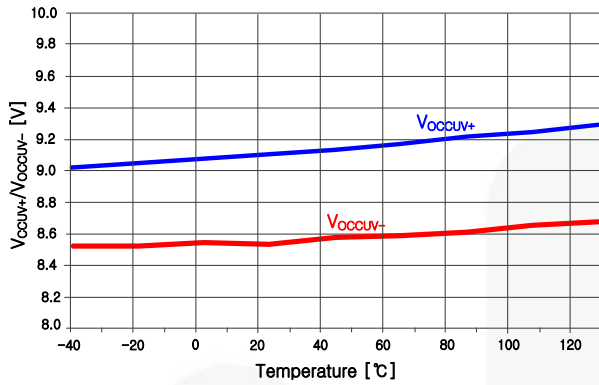

Figure 29. V_{CC} UVLO Threshold Voltage vs. Temperature

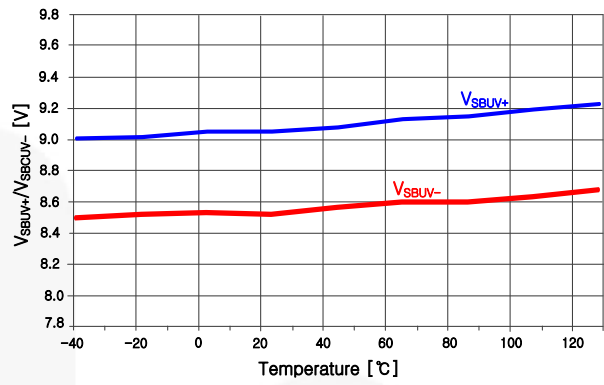

Figure 30. V_{BS} UVLO Threshold Voltage vs. Temperature

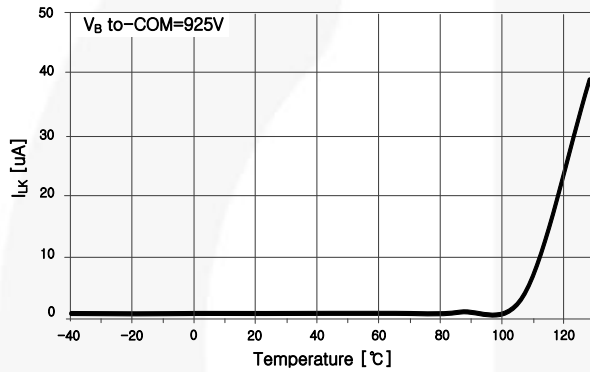

Figure 31. V_B to COM Leakage Current vs. Temperature

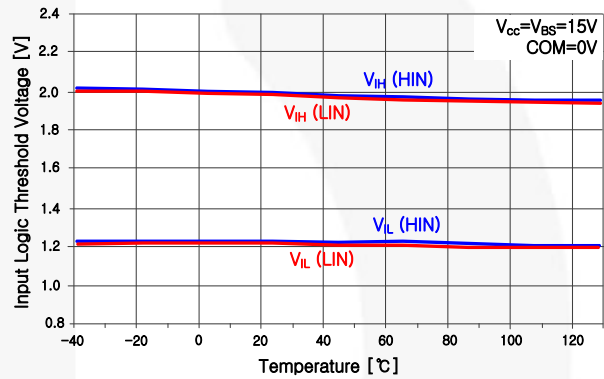

Figure 32. Input Logic Threshold Voltage vs. Temperature

Switching Time Definitions

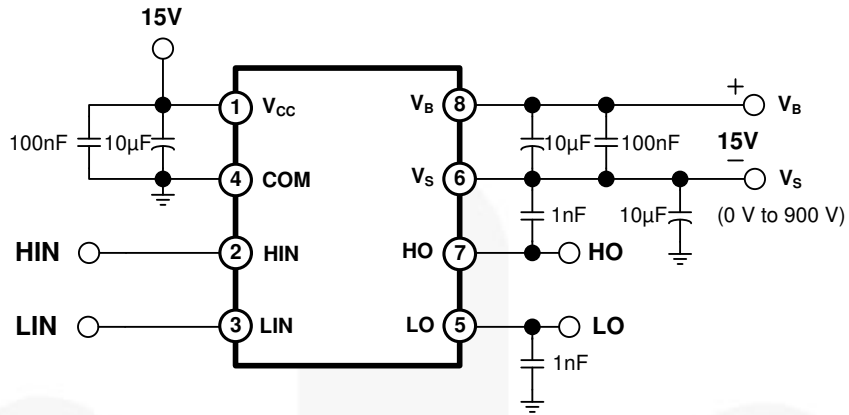

Figure 33. Switching Time Test Circuit

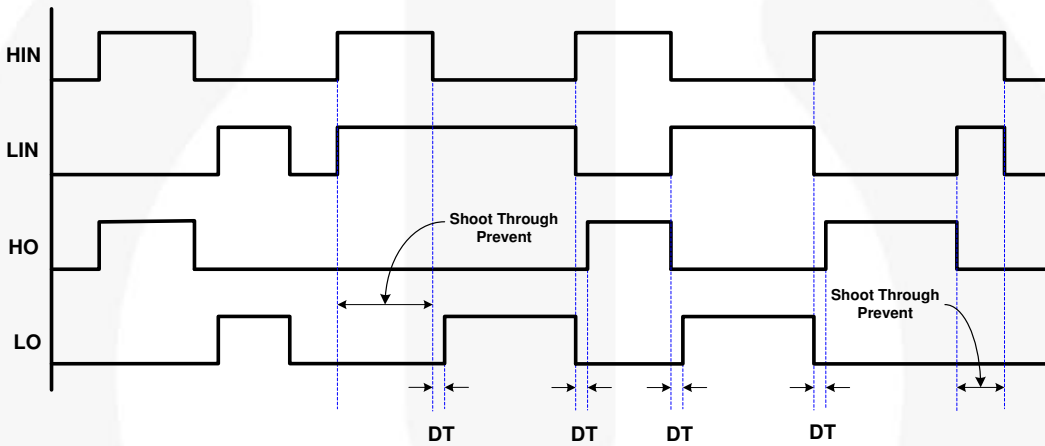

Figure 34. Input / Output Timing Diagram

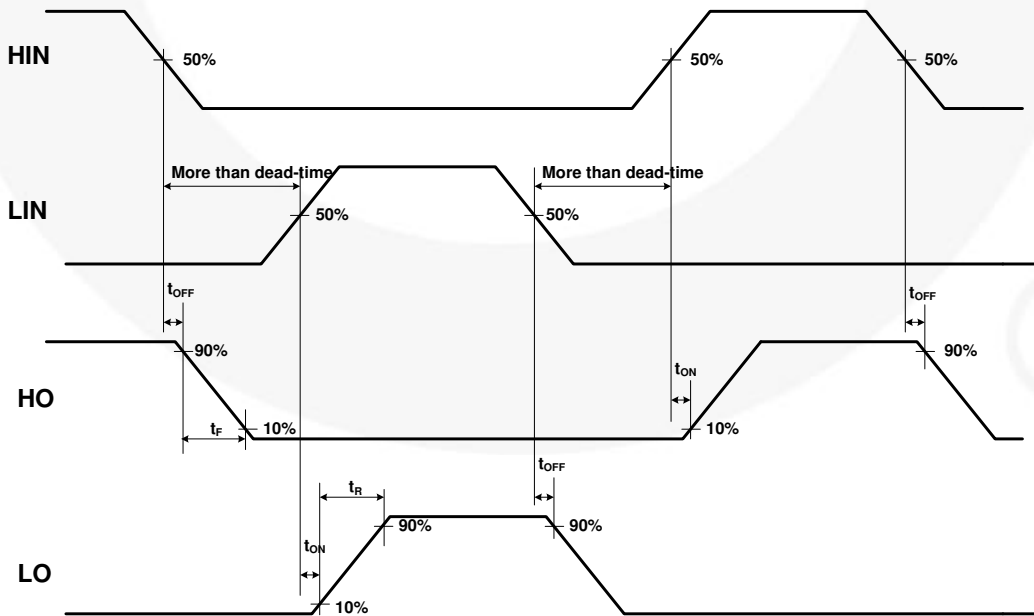

Figure 35. Switching Time Definition

Switching Time Definitions (Continued)

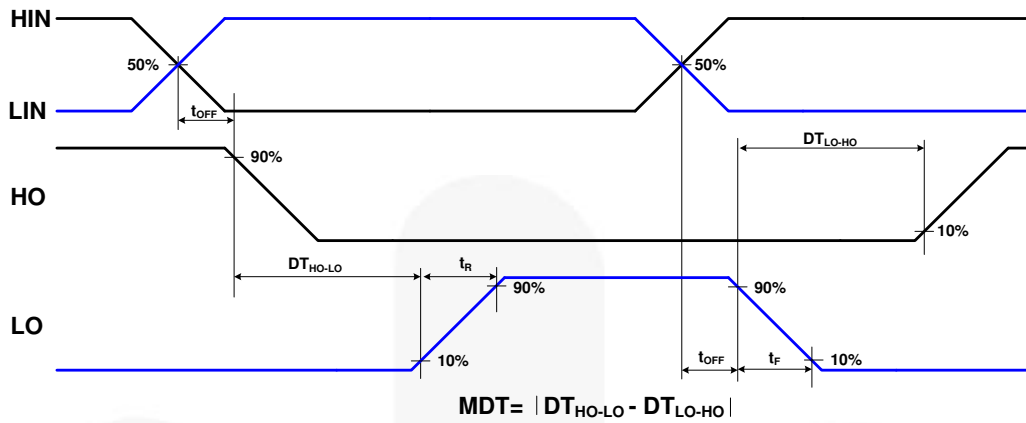
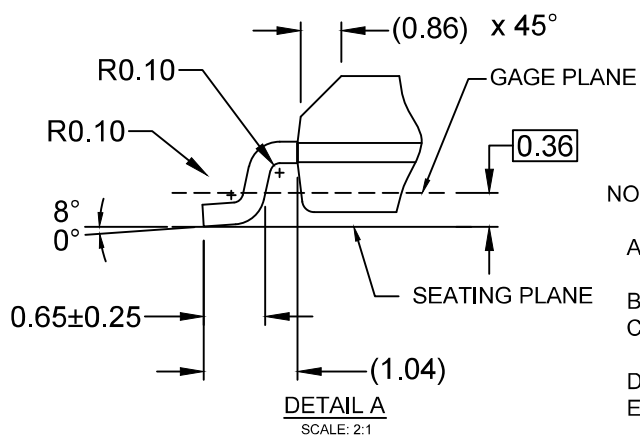
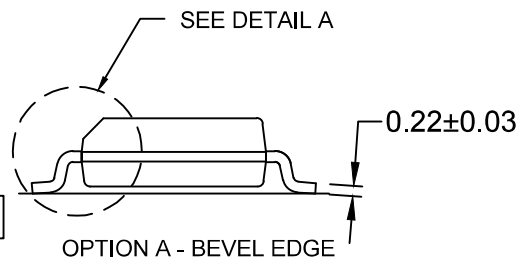
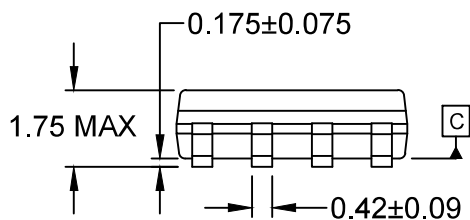
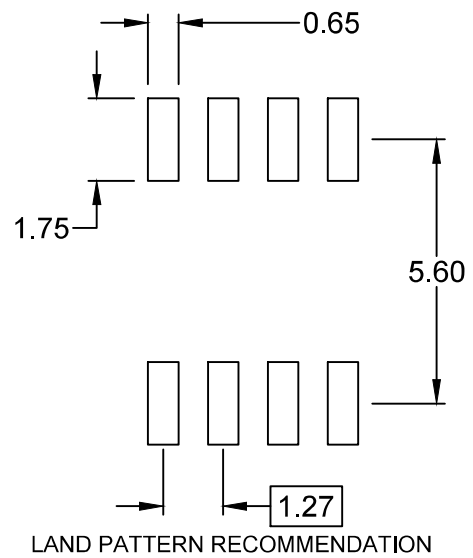
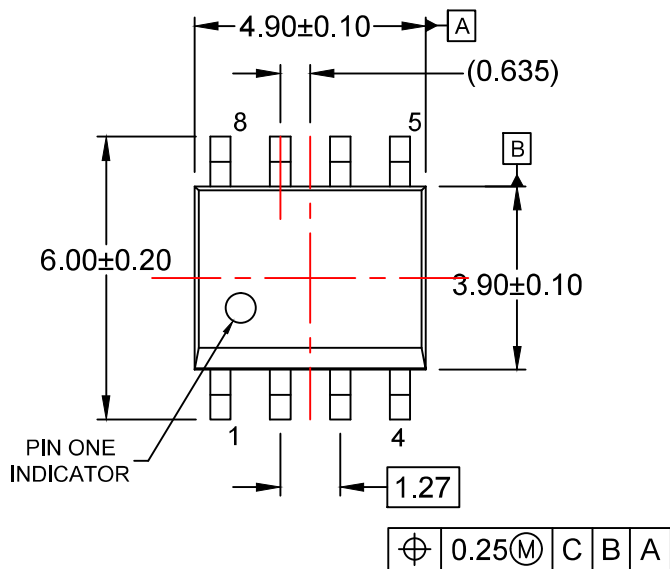

Figure 36. Internal Dead Time Definition



NOTES:

- A) THIS PACKAGE CONFORMS TO JEDEC MS-012, VARIATION AA.
- B) ALL DIMENSIONS ARE IN MILLIMETERS.
- C) DIMENSIONS DO NOT INCLUDE MOLD FLASH OR BURRS.
- D) LANDPATTERN STANDARD: SOIC127P600X175-8M
- E) DRAWING FILENAME: M08Arev16



ON Semiconductor and  are trademarks of Semiconductor Components Industries, LLC dba ON Semiconductor or its subsidiaries in the United States and/or other countries. ON Semiconductor owns the rights to a number of patents, trademarks, copyrights, trade secrets, and other intellectual property. A listing of ON Semiconductor's product/patent coverage may be accessed at www.onsemi.com/site/pdf/Patent-Marking.pdf. ON Semiconductor reserves the right to make changes without further notice to any products herein. ON Semiconductor makes no warranty, representation or guarantee regarding the suitability of its products for any particular purpose, nor does ON Semiconductor assume any liability arising out of the application or use of any product or circuit, and specifically disclaims any and all liability, including without limitation special, consequential or incidental damages. Buyer is responsible for its products and applications using ON Semiconductor products, including compliance with all laws, regulations and safety requirements or standards, regardless of any support or applications information provided by ON Semiconductor. "Typical" parameters which may be provided in ON Semiconductor data sheets and/or specifications can and do vary in different applications and actual performance may vary over time. All operating parameters, including "Typicals" must be validated for each customer application by customer's technical experts. ON Semiconductor does not convey any license under its patent rights nor the rights of others. ON Semiconductor products are not designed, intended, or authorized for use as a critical component in life support systems or any FDA Class 3 medical devices or medical devices with a same or similar classification in a foreign jurisdiction or any devices intended for implantation in the human body. Should Buyer purchase or use ON Semiconductor products for any such unintended or unauthorized application, Buyer shall indemnify and hold ON Semiconductor and its officers, employees, subsidiaries, affiliates, and distributors harmless against all claims, costs, damages, and expenses, and reasonable attorney fees arising out of, directly or indirectly, any claim of personal injury or death associated with such unintended or unauthorized use, even if such claim alleges that ON Semiconductor was negligent regarding the design or manufacture of the part. ON Semiconductor is an Equal Opportunity/Affirmative Action Employer. This literature is subject to all applicable copyright laws and is not for resale in any manner.

PUBLICATION ORDERING INFORMATION

LITERATURE FULFILLMENT:

Literature Distribution Center for ON Semiconductor
19521 E. 32nd Pkwy, Aurora, Colorado 80011 USA
Phone: 303-675-2175 or 800-344-3860 Toll Free USA/Canada
Fax: 303-675-2176 or 800-344-3867 Toll Free USA/Canada
Email: orderlit@onsemi.com

N. American Technical Support: 800-282-9855 Toll Free
USA/Canada
Europe, Middle East and Africa Technical Support:
Phone: 421 33 790 2910
Japan Customer Focus Center
Phone: 81-3-5817-1050

ON Semiconductor Website: www.onsemi.com
Order Literature: <http://www.onsemi.com/orderlit>
For additional information, please contact your local
Sales Representative