

Part Number: AAA3528AVU/ANSGCT

Pure Orange  
Super Bright Green

### Features

- Surface mount type.
- Compatible with automatic placement equipment.
- Compatible with infrared and vapor phase solder processes.
- Black case enhances contrast ratio.
- Housing material meets UL94V-0 flammability rating.
- Lens material meets UL94-HB flammability rating.
- Moisture sensitivity level : level 3.
- RoHS compliant.

### Descriptions

- The Pure Orange source color devices are made with Gallium Arsenide Phosphide on Gallium Phosphide Pure Orange Light Emitting Diode.
- The Super Bright Green source color devices are made with Gallium Phosphide Green Light Emitting Diode.

### Package Dimensions

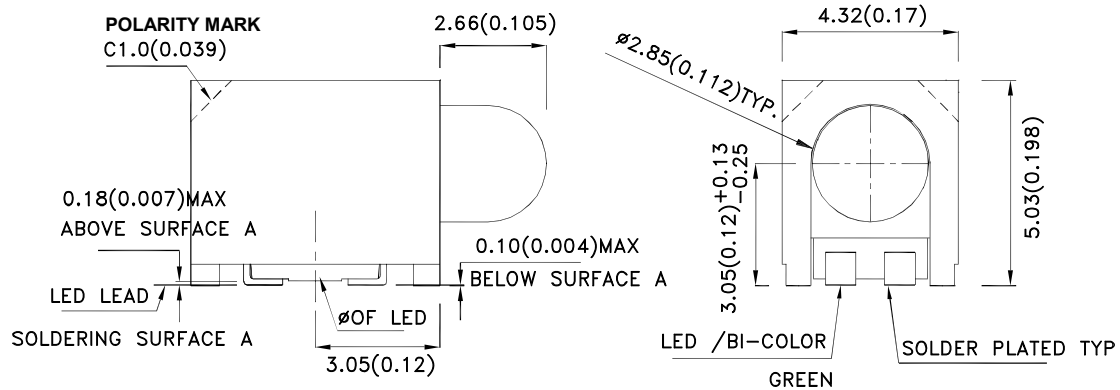

### Recommended Soldering Pattern

Tolerance:  $\pm 0.1 (0.004)$

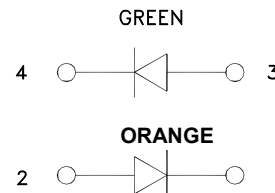
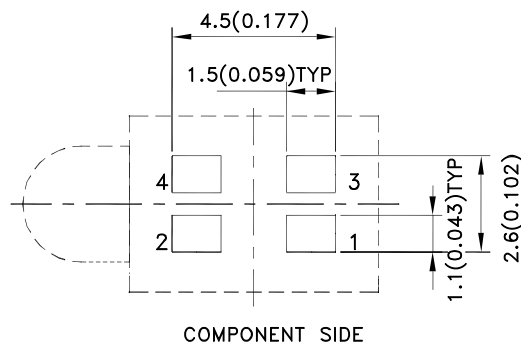

#### Notes:

1. All dimensions are in millimeters (inches).
2. Tolerance is  $\pm 0.25 (0.01)$  unless otherwise noted.
3. The specifications, characteristics and technical data described in the datasheet are subject to change without prior notice.
4. The device has a single mounting surface. The device must be mounted according to the specifications.



## Selection Guide

| Part No.          | Emitting Color (Material) | Lens Type   | Iv (mcd) [2]<br>@ 20mA |      | Viewing<br>Angle [1] |
|-------------------|---------------------------|-------------|------------------------|------|----------------------|
|                   |                           |             | Min.                   | Typ. | 2θ1/2                |
| AAA3528AVU/ANSRCT | Pure Orange (GaAsP/GaP)   | Water Clear | 5                      | 12   | 50°                  |
|                   | Super Bright Green (GaP)  |             | 5                      | 9    |                      |

Notes:

1. θ1/2 is the angle from optical centerline where the luminous intensity is 1/2 of the optical peak value.
2. Luminous intensity / luminous Flux: +/-15%.
3. Luminous intensity value is traceable to CIE127-2007 standards.

## Electrical / Optical Characteristics at TA=25°C

| Symbol                | Parameter                | Emitting Color                    | Typ.        | Max.       | Units | Test Conditions           |
|-----------------------|--------------------------|-----------------------------------|-------------|------------|-------|---------------------------|
| $\lambda_{peak}$      | Peak Wavelength          | Pure Orange<br>Super Bright Green | 607<br>565  |            | nm    | I <sub>F</sub> =20mA      |
| $\lambda_D$ [1]       | Dominant Wavelength      | Pure Orange<br>Super Bright Green | 602<br>568  |            | nm    | I <sub>F</sub> =20mA      |
| $\Delta\lambda_{1/2}$ | Spectral Line Half-width | Pure Orange<br>Super Bright Green | 35<br>30    |            | nm    | I <sub>F</sub> =20mA      |
| C                     | Capacitance              | Pure Orange<br>Super Bright Green | 15<br>15    |            | pF    | V <sub>F</sub> =0V;f=1MHz |
| V <sub>F</sub> [2]    | Forward Voltage          | Pure Orange<br>Super Bright Green | 2.05<br>2.2 | 2.5<br>2.5 | V     | I <sub>F</sub> =20mA      |
| I <sub>R</sub>        | Reverse Current          | Pure Orange<br>Super Bright Green |             | 10<br>10   | uA    | V <sub>R</sub> = 5V       |

Notes:

1. Wavelength: +/-1nm.
2. Forward Voltage: +/-0.1V.
3. Wavelength value is traceable to CIE127-2007 standards.
4. Excess driving current and / or operating temperature higher than recommended conditions may result in severe light degradation or premature failure.

## Absolute Maximum Ratings at TA=25°C

| Parameter                | Pure Orange     | Super Bright Green | Units |
|--------------------------|-----------------|--------------------|-------|
| Power dissipation        | 62.5            | 62.5               | mW    |
| DC Forward Current       | 25              | 25                 | mA    |
| Peak Forward Current [1] | 145             | 140                | mA    |
| Reverse Voltage          | 5               |                    | V     |
| Operating Temperature    | -40°C To +85°C  |                    |       |
| Storage Temperature      | -40°C To +100°C |                    |       |

Notes:

1. 1/10 Duty Cycle, 0.1ms Pulse Width.
2. Relative humidity levels maintained between 40% and 60% in production area are recommended to avoid the build-up of static electricity – Ref JEDEC/JESD625-A and JEDEC/J-STD-033.

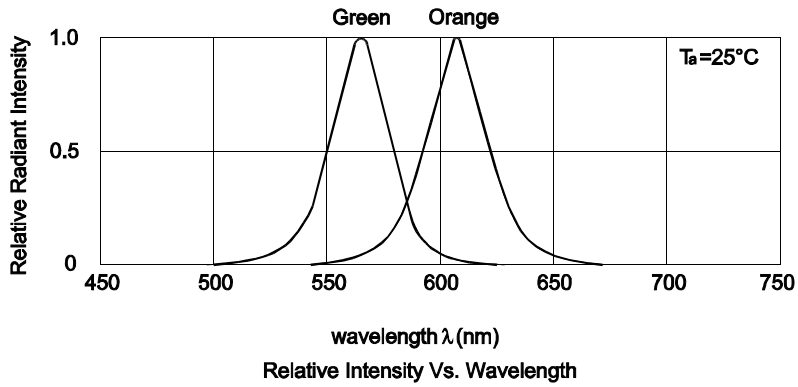

## AAA3528AVU/ANSGBT Pure Orange

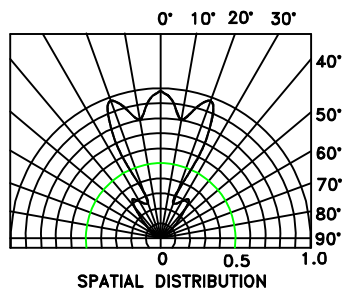
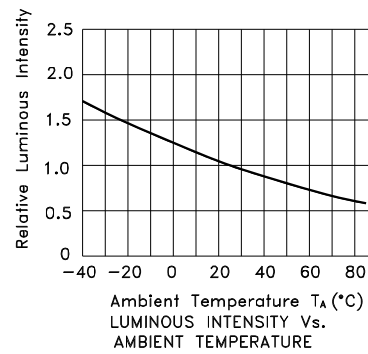
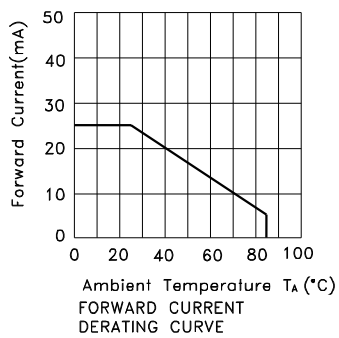
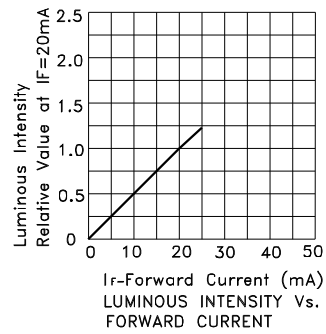
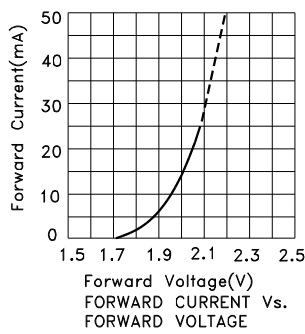

## Super Bright Green

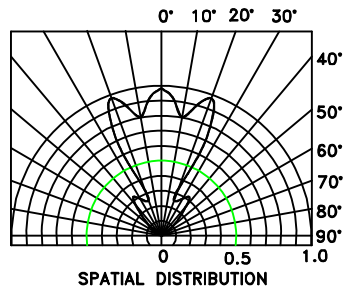
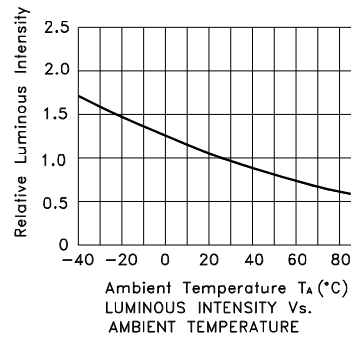
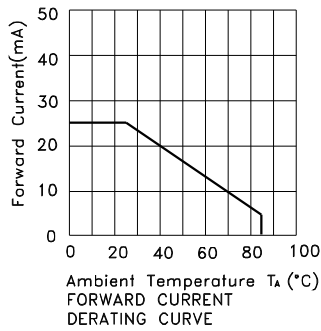
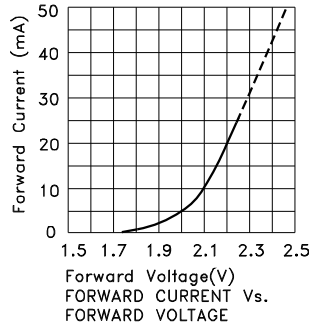

## AAA3528AVU/ANSCT

Reflow soldering is recommended and the soldering profile is shown below.  
Other soldering methods are not recommended as they might cause damage to the product.

Reflow Soldering Profile For Lead-free SMT Process.



NOTES:

1. We recommend the reflow temperature 245°C (+/-5°C). The maximum soldering temperature should be limited to 260°C.
2. Don't cause stress to the epoxy resin while it is exposed to high temperature.
3. Number of reflow process shall be 2 times or less.

### Reel Dimension

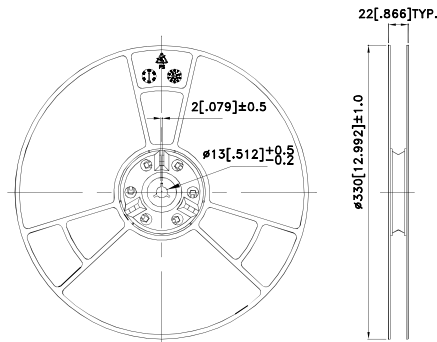

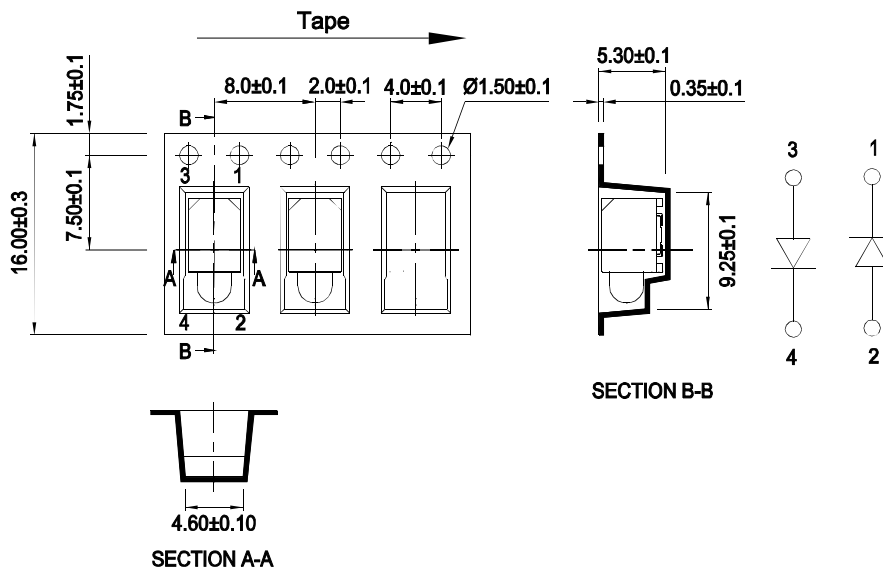

### Tape Dimensions (Units : mm)

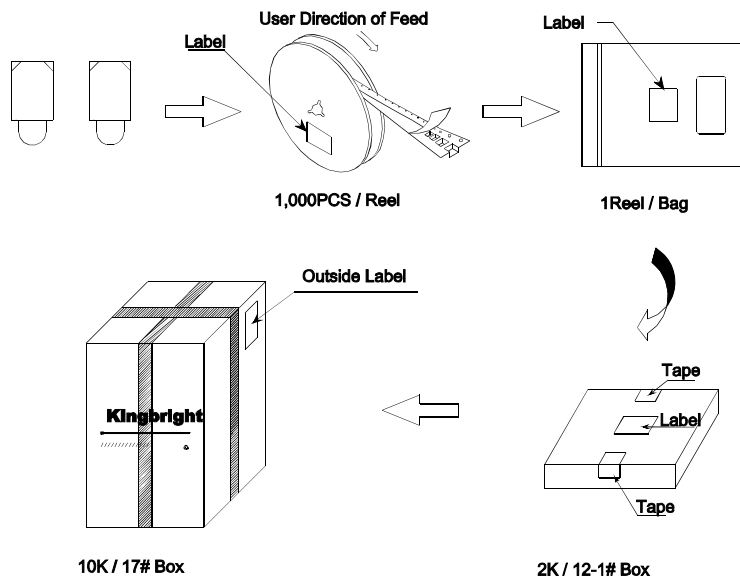

## PACKING & LABEL SPECIFICATIONS

AAA3528AVU/ANSCT



|   |      |                            |
|---|------|----------------------------|
| <b>Kingbright</b>   |      |                            |
| P/NO: AAA3528AVUxxx   |      |                            |
| QTY: 1,000 pcs  | Q.C. | Q C<br>XXXX:XXXX<br>PASSED |
| S/N: XXXX   |      |                            |
| CODE: XXX   |      |                            |
| LOT NO:   |      |                            |
|  |      |                            |
| RoHS Compliant  |      |                            |

### Terms and conditions for the usage of this document

1. The information included in this document reflects representative usage scenarios and is intended for technical reference only.
2. The part number, type, and specifications mentioned in this document are subject to future change and improvement without notice. Before production usage customer should refer to the latest datasheet for the updated specifications.
3. When using the products referenced in this document, please make sure the product is being operated within the environmental and electrical limits specified in the datasheet. If customer usage exceeds the specified limits, Kingbright will not be responsible for any subsequent issues.
4. The information in this document applies to typical usage in consumer electronics applications. If customer's application has special reliability requirements or have life-threatening liabilities, such as automotive or medical usage, please consult with Kingbright representative for further assistance.
5. The contents and information of this document may not be reproduced or re-transmitted without permission by Kingbright.
6. All design applications should refer to Kingbright application notes available at <http://www.KingbrightUSA.com/ApplicationNotes>

## Application Notes

### Introduction

Kingbright AAA3528AVU series are surface-mounted right-angle light-emitting diode (LED) circuit-board indicators. It offers the convenience of surface-mount production while offering the right-angle height profile of circuit-board indicator lamps. The part is suitable for automated SMT and lead-free reflow soldering production. The clear silicone lens extends out to provide broad viewing angles. When installed on customer's circuit board, it can provide illuminated indication or backlight panel indicators.

### Transport and Storage

Surface mount devices (SMD) are moisture sensitive components. atmospheric moisture will seep into the component package, so when placed on the circuit board for 160-200°C reflow soldering, the high temperatures cause the absorbed moisture to vaporize and rapidly expand, creating vapor pressure that could damage the LED component by causing cracks in the lens, delamination of the chip and wire bonds, or other reliability issues.

#### 1. Transportation

The product is packed in anti-static, moisture-proof mylar bags. The package should be carefully handled to avoid external pressure and accidental puncture during transport. Proper anti-static practices should be in place. If package leakage or damage is found before opening, suggest customer take the damaged package off-line for additional testing and bake to dry before use.

#### 2. Storage Conditions (Before Opening)

To prevent moisture-absorption reliability issues, the parts must be properly stored. Suggest do not open the moisture-proof package until immediately before usage (except for sample inspection purposes). The opened package must be re-sealed with fresh desiccant and humidity indicator and stored in a dry box (<30°C/60% RH).

#### 3. Humidity Control (After Opening)

After opening the moisture-proof packaging, immediately check the humidity indicator card contained inside to confirm the parts have been exposed to excess moisture. The production environment should follow IPC/JEDEC J-STD-020 standards for temperature, humidity, and exposure time.

SMD environmental exposure time accumulates as long as the parts are outside the packaging, unless they are being baked dry.

Table 1: IPC/JEDEC J-STD-020 Moisture Sensitivity Levels (MSL)

| MSL      | Allowed Exposure After Opening |               |
|----------|--------------------------------|---------------|
|          | Time                           | Conditions    |
| LEVEL 1  | No Limit                       | ≤ 30°C /85%RH |
| LEVEL 2  | 1 Year                         | ≤ 30°C /60%RH |
| LEVEL 2a | 4 Weeks                        | ≤ 30°C /60%RH |
| LEVEL 3  | 168 Hours                      | ≤ 30°C /60%RH |
| LEVEL 4  | 72 Hours                       | ≤ 30°C /60%RH |
| LEVEL 5  | 48 Hours                       | ≤ 30°C /60%RH |
| LEVEL 5a | 24 Hours                       | ≤ 30°C /60%RH |
| LEVEL 6  | Immediately upon open          | ≤ 30°C /60%RH |

#### 4. Storage of Unused And Remaining Parts

If the full reel was not consumed during production, the production environment was within limits (<30°C/60% RH), and the exposure time did not exceed the limits in Table 1, then the remaining parts may be stored as below:

- Re-sealed with desiccant.
- Stored within a dry box (5% RH). The dry box storage time would not count against the total exposure time. When the stored parts are taken out, the exposure time is accumulated from the previous production run.

## Application Notes

### 5. Humidity Control Of PCB-Mounted Parts

If the moisture-sensitive SMD parts will not undergo further reflow or other high-temperature processes, then no special treatment is required. However, if the PCB assembly requires further reflow or other high-temperature process, including rework, then the mounted SMD's exposure time should continue to accumulate against the MSL limit, unless the board is kept in a dry environment (<5% RH). If the exposure time exceeds the MSL limit, the board and part must be baked dry to reset the exposure time before undergoing further reflow.

### Installation and Usage

If the part's silicone lens extends beyond the board's edge after installation, proper protection should be made (such as covers) to prevent accidental impact or stress on the exposed lens that would cause damage or detachment. The silicone lens may withstand up to 1.5-newton in shear force when properly mounted. If external protection is not available, strongly suggest following these handling procedures to prevent damage:

1. When the PCB assembly is handled or transported after reflow soldering, care must be taken to prevent accidental contact or impact on the exposed silicone lens.
2. When the PCB assembly is installed into the casing or panel, care must be taken to maintain sufficient clearance for the lens.
3. Do not subject the silicone lens to outside impact or friction.

### Cleaning

1. Do not use unknown chemicals or acidic solvents to clean the part. Please check to insure the cleaning solvent will not corrode epoxy resin, silicone resin, silver plating, and other component materials before using.
2. Kingbright suggests ethanol as a safe solvent for use with the surface mount devices. Softly wipe away any surface particles, avoiding excessive force scratching the surface or damaging the structures. Then place down and allow to naturally dry under room temperature conditions before further use. Do not soak the component in the solvent.