



300mA Low Dropout CMOS Positive Voltage Regulator

CMOS Positive Voltage Regulator

Description

The FM2123 series of positive, linear regulators feature low quiescent current (30 μ A typ.) with low dropout voltage, making them ideal for battery applications. These rugged devices have both Thermal Shutdown, and Current Fold-back to prevent device failure under the "Worst" of operating conditions. The GM2123 is stable with an output capacitance of 2.2 μ F or greater.

Features

- Very Low Dropout Voltage
- Guaranteed 300mA output
- Over-Temperature Shutdown
- Current Limiting
- Short Circuit Current Fold-back
- Factory Pre-set Output Voltage
- Highly Accurate $\pm 1.5\%$
- Low Temperature Coefficient

Applications

- Battery Powered Widgets
- Instrumentation
- Wireless Devices
- Cordless Phones
- PC Peripherals
- Portable Electronics
- Electronic Scales

Package Dimensions

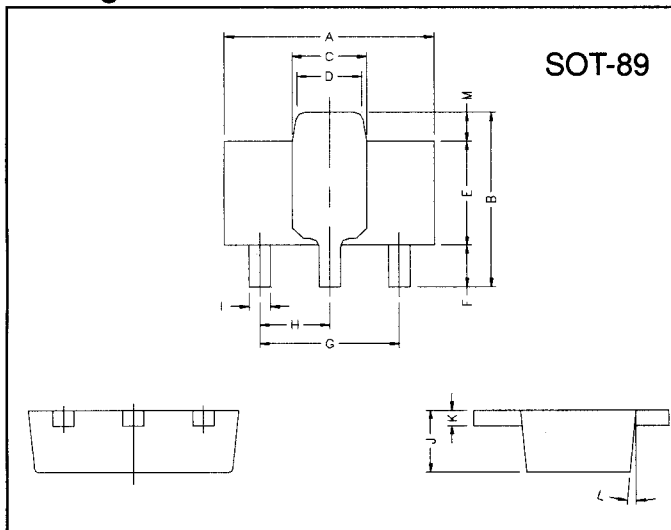

Block Diagram

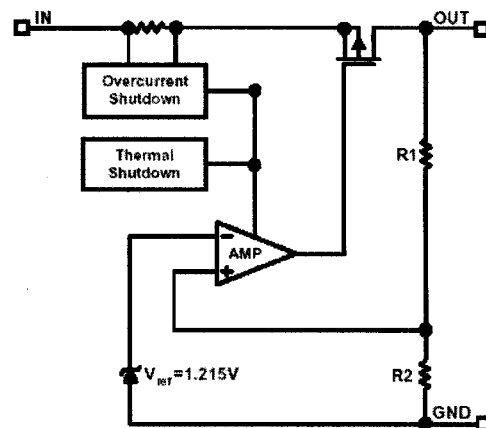

Marking :

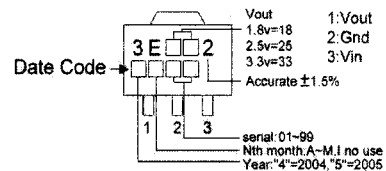

REF.	Millimeter		REF.	Millimeter	
	Min.	Max.		Min.	Max.
A	4.4	4.6	G	3.00	REF.
B	4.05	4.25	H	1.50	REF.
C	1.50	1.70	I	0.40	0.52
D	1.30	1.50	J	1.40	1.60
E	2.40	2.60	K	0.35	0.41
F	0.89	1.20	L	5° TYP.	
			M	0.70 REF.	

Typical Application Circuit

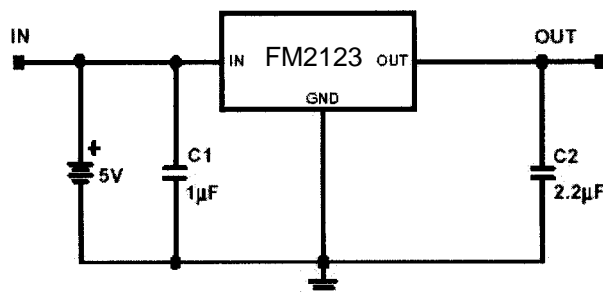



300mA Low Dropout CMOS Positive Voltage Regulator

Absolute Maximum Ratings

Parameter	Symbol	Ratings	Unit
Input Voltage	V _{IN}	8	V
Output Current	I _{OUT}	PD/(V _{IN} -V _O)	mA
Output Voltage	V _{OUT}	1.3~5	V
Operating Ambient Temperature	T _{opr}	-40 ~ +85	°C
Junction Temperature	T _j	-40 ~ +125	°C
Maximum Junction Temperature	T _{j Max}	150	°C
Thermal Resistance	θ _{jc}	38	°C/W
	θ _{ja}	180	°C/W
Power Dissipation(ΔT=100°C)	PD	550	mW
EDS Classification		B	

Electrical Characteristics Ta=25°C

Parameter	Symbol	Condition	Min	TYP	Max	Unit	
Output Voltage	V _{OUT(E)} (Note1)	V _{IN} =V _{OUT(T)} +1V, I _o =1mA	-1.5%	V _{OUT(T)} (Note2)	1.5%	V	
Output Current	I _o	V _{IN} =V _{OUT(T)} +2V, V _{OUT} ≥V _{OUT(E)} *0.96	300	-	-	mA	
Current Limit	I _{LIM}	V _O >1.2V	300	450	-	mA	
Load Regulation	REG _{LOAD}	V _{IN} =V _{OUT(T)} +2V, I _o =1mA to 300mA	-1	0.2	1	%	
Dropout Voltage	V _{DROPOUT}	I _o =300mA V _O =V _{OUT(E)} -2%	1.3V ≤ V _{OUT(T)} ≤ 2.0V	-	-	1300	mV
			2.0V < V _{OUT(T)} ≤ 2.8V	-	-	400	
			2.8V < V _{OUT(T)}	-	-	300	
Quiescent Current	I _q	V _{IN} =V _{OUT(T)} +1V	-	30	50	μA	
Line Regulation	REG _{LINE}	I _o =1mA V _{IN} =V _{OUT(T)} +1 to V _{OUT(T)} +2	1.3V ≤ V _{OUT(T)} ≤ 1.4V	-0.2	-	0.2	%
			1.4V < V _{OUT(T)} ≤ 2.0V	-0.15	-	0.15	
			2.0V < V _{OUT(T)} < 4.0V	-0.1	0.02	0.1	
			4.0V ≤ V _{OUT(T)}	-0.4	0.2	0.4	
Input Voltage	V _{IN}		Note3	-	7	V	
Over Temperature Shutdown	OTS		-	150	-	°C	
Over Temperature Hysteresis	OTH		-	30	-	°C	
Output Voltage Temperature Coefficient	TC		-	30	-	ppm/°C	
Short Circuit Current(Note4)	I _{SC}	V _{IN} =V _{OUT(T)} +1V V _{OUT} =0V	-	150	300	mA	
Power Supply Rejection	PSRR	I _o =100mA C _o =2.2μF	f=1kHz	-	50	-	dB
			f=10kHz	-	20	-	
			f=100kHz	-	15	-	
Output Voltage Noise	e _N	f=10Hz~100kHz I _o =10mA				μVrms	

Note 1: V_{OUT(E)} =Effective Output Voltage (i.e. the output voltage when "V_{OUT(T)} +1.0V" is provided at the V_{IN} pin while maintaining a certain I_{OUT} value).

2: V_{OUT(T)} =Specified Output Voltage

3: V_{IN(MIN)} =V_{OUT}+V_{DROPOUT}

4: To prevent the Short Circuit Current protection feature from being prematurely activated, the input voltage must be applied before a current source load is applied.



300mA Low Dropout CMOS Positive Voltage Regulator

Ordering Information (contd.)

Part Number	Marking	Output Voltage	Part Number	Marking	Output Voltage
FM2123-13	3E132 XXXX	1.3V	FM2123-15	3E152 XXXX	1.5V
FM2123-18	3E182 XXXX	1.8V	FM2123-19	3E192 XXXX	1.9V
FM2123-20	3E202 XXXX	2.0V	FM2123-25	3E252 XXXX	2.5V
FM2123-27	3E272 XXXX	2.7V	FM2123-28	3E282 XXXX	2.8V
FM2123-29	3E292 XXXX	2.9V	FM2123-30	3E302 XXXX	3.0V
FM2123-31	3E312 XXXX	3.1V	FM2123-33	3E332 XXXX	3.3V
FM2123-34	3E342 XXXX	3.4V	FM2123-35	3E352 XXXX	3.5V
FM2123-36	3E362 XXXX	3.6V	FM2123-37	3E372 XXXX	3.7V
FM2123-38	3E382 XXXX	3.8V	FM2123-50	3E502 XXXX	5.0V

Characteristics Curve

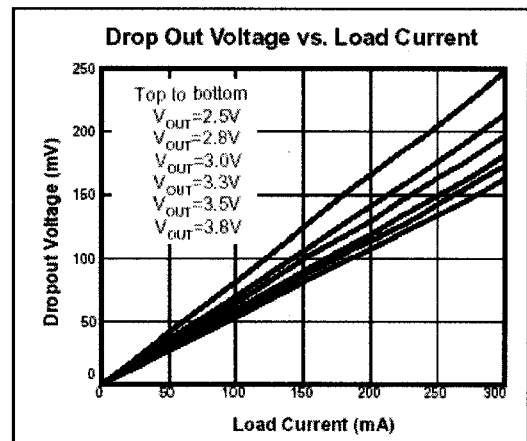
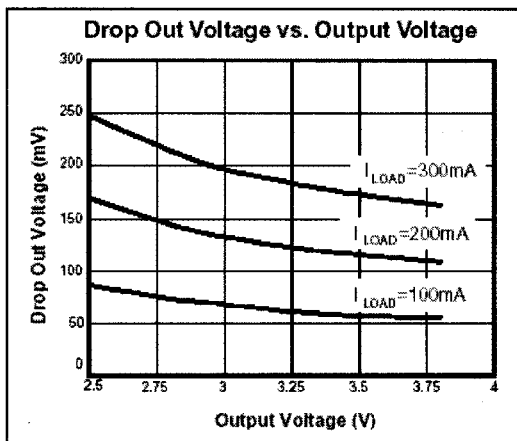
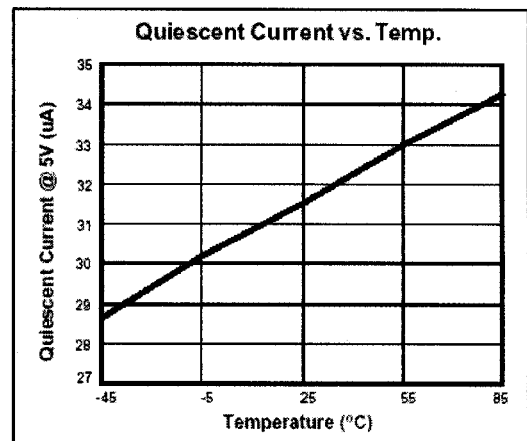
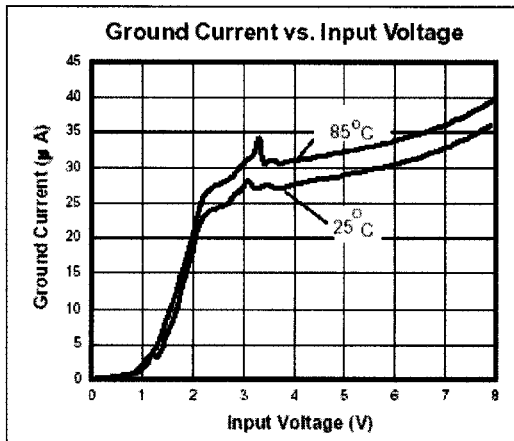



300mA Low Dropout CMOS Positive Voltage Regulator

