

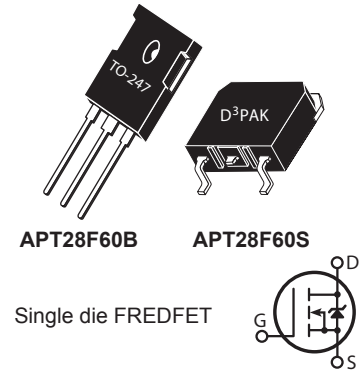

N-Channel FREDFET

Power MOS 8™ is a high speed, high voltage N-channel switch-mode power MOSFET. This 'FREDFET' version has a drain-source (body) diode that has been optimized for high reliability in ZVS phase shifted bridge and other circuits through reduced t_{rr} , soft recovery, and high recovery dv/dt capability. Low gate charge, high gain, and a greatly reduced ratio of C_{rSS}/C_{iSS} result in excellent noise immunity and low switching loss. The intrinsic gate resistance and capacitance of the poly-silicon gate structure help control di/dt during switching, resulting in low EMI and reliable paralleling, even when switching at very high frequency.



FEATURES

- Fast switching with low EMI
- Low t_{rr} for high reliability
- Ultra low C_{rSS} for improved noise immunity
- Low gate charge
- Avalanche energy rated
- RoHS compliant 

TYPICAL APPLICATIONS

- ZVS phase shifted and other full bridge
- Half bridge
- PFC and other boost converter
- Buck converter
- Single and two switch forward
- Flyback

Absolute Maximum Ratings

Symbol	Parameter	Ratings	Unit
I_D	Continuous Drain Current @ $T_C = 25^\circ C$	30	A
	Continuous Drain Current @ $T_C = 100^\circ C$	19	
I_{DM}	Pulsed Drain Current ^①	105	
V_{GS}	Gate-Source Voltage	±30	V
E_{AS}	Single Pulse Avalanche Energy ^②	780	mJ
I_{AR}	Avalanche Current, Repetitive or Non-Repetitive	14	A

Thermal and Mechanical Characteristics

Symbol	Characteristic	Min	Typ	Max	Unit
P_D	Total Power Dissipation @ $T_C = 25^\circ C$			520	W
$R_{\theta JC}$	Junction to Case Thermal Resistance			0.24	$^\circ C/W$
$R_{\theta CS}$	Case to Sink Thermal Resistance, Flat, Greased Surface		0.11		
T_J, T_{STG}	Operating and Storage Junction Temperature Range	-55		150	$^\circ C$
T_L	Soldering Temperature for 10 Seconds (1.6mm from case)			300	
W_T	Package Weight		0.22		oz
			6.2		g
Torque	Mounting Torque (TO-264 Package), 4-40 or M3 screw			10	in·lbf
				1.1	N·m

Static Characteristics
T_J = 25°C unless otherwise specified
APT28F60B_S

Symbol	Parameter	Test Conditions	Min	Typ	Max	Unit
V _{BR(DSS)}	Drain-Source Breakdown Voltage	V _{GS} = 0V, I _D = 250μA	600			V
ΔV _{BR(DSS)}/ΔT_J}	Breakdown Voltage Temperature Coefficient	Reference to 25°C, I _D = 250μA		0.57		V/°C
R _{DS(on)}	Drain-Source On Resistance ^③	V _{GS} = 10V, I _D = 14A		0.17	0.22	Ω
V _{GS(th)}	Gate-Source Threshold Voltage	V _{GS} = V _{DS} , I _D = 1mA	2.5	4	5	V
ΔV _{GS(th)}/ΔT_J}	Threshold Voltage Temperature Coefficient			-10		mV/°C
I _{DSS}	Zero Gate Voltage Drain Current	V _{DS} = 600V V _{GS} = 0V			250	μA
		T _J = 25°C T _J = 125°C			1000	
I _{GSS}	Gate-Source Leakage Current	V _{GS} = ±30V			±100	nA

Dynamic Characteristics
T_J = 25°C unless otherwise specified

Symbol	Parameter	Test Conditions	Min	Typ	Max	Unit
g _{fs}	Forward Transconductance	V _{DS} = 50V, I _D = 14A		27		S
C _{iss}	Input Capacitance	V _{GS} = 0V, V _{DS} = 25V f = 1MHz		5575		pF
C _{rss}	Reverse Transfer Capacitance			55		
C _{oss}	Output Capacitance			510		
C _{o(cr)} ^④	Effective Output Capacitance, Charge Related	V _{GS} = 0V, V _{DS} = 0V to 400V		270		pF
C _{o(er)} ^⑤	Effective Output Capacitance, Energy Related			140		
Q _g	Total Gate Charge	V _{GS} = 0 to 10V, I _D = 14A, V _{DS} = 300V		140		nC
Q _{gs}	Gate-Source Charge			30		
Q _{gd}	Gate-Drain Charge			60		
t _{d(on)}	Turn-On Delay Time	Resistive Switching V _{DD} = 400V, I _D = 14A R _G = 4.7Ω ^⑥ , V _{GG} = 15V		31		ns
t _r	Current Rise Time			36		
t _{d(off)}	Turn-Off Delay Time			95		
t _f	Current Fall Time			29		

Source-Drain Diode Characteristics

Symbol	Parameter	Test Conditions	Min	Typ	Max	Unit
I _S	Continuous Source Current (Body Diode)	MOSFET symbol showing the integral reverse p-n junction diode (body diode)			30	A
I _{SM}	Pulsed Source Current (Body Diode) ^①				105	
V _{SD}	Diode Forward Voltage	I _{SD} = 14A, T _J = 25°C, V _{GS} = 0V			1.0	V
t _{rr}	Reverse Recovery Time	I _{SD} = 14A ^③ di _{SD} /dt = 100A/μs V _{DD} = 100V	T _J = 25°C		230	ns
			T _J = 125°C		430	
Q _{rr}	Reverse Recovery Charge		T _J = 25°C		0.83	μC
			T _J = 125°C		2.07	
I _{rrm}	Reverse Recovery Current		T _J = 25°C		8.0	A
		T _J = 125°C		11.2		
dv/dt	Peak Recovery dv/dt	I _{SD} ≤ 14A, di/dt ≤ 1000A/μs, V _{DD} = 400V, T _J = 125°C			20	V/ns

① Repetitive Rating: Pulse width and case temperature limited by maximum junction temperature.

② Starting at T_J = 25°C, L = 7.96mH, R_G = 25Ω, I_{AS} = 14A.

③ Pulse test: Pulse Width < 380μs, duty cycle < 2%.

④ C_{o(cr)} is defined as a fixed capacitance with the same stored charge as C_{oss} with V_{DS} = 67% of V_{(BR)DSS}.

⑤ C_{o(er)} is defined as a fixed capacitance with the same stored energy as C_{oss} with V_{DS} = 67% of V_{(BR)DSS}. To calculate C_{o(er)} for any value of V_{DS} less than V_{(BR)DSS}, use this equation: C_{o(er)} = -1.33E-7/V_{DS}² + 3.06E-8/V_{DS} + 8.83E-11.

⑥ R_G is external gate resistance, not including internal gate resistance or gate driver impedance. (MIC4452)

Microsemi reserves the right to change, without notice, the specifications and information contained herein.

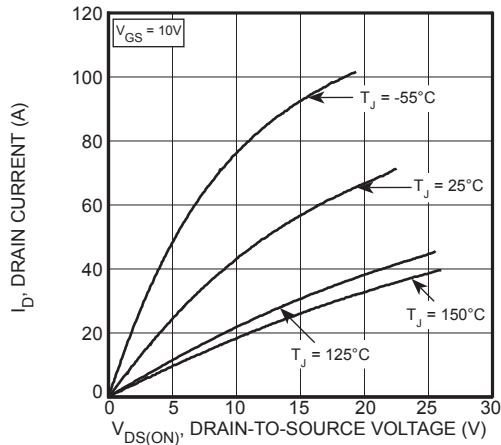

Figure 1, Output Characteristics

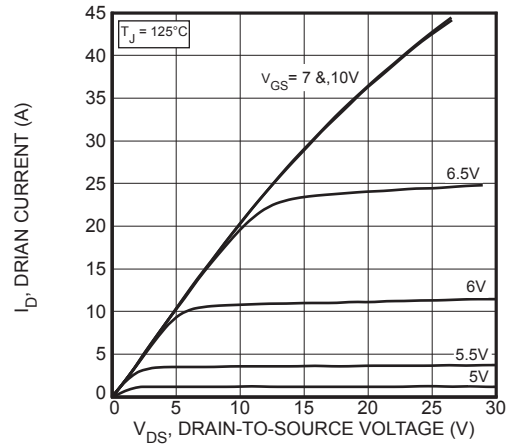

Figure 2, Output Characteristics

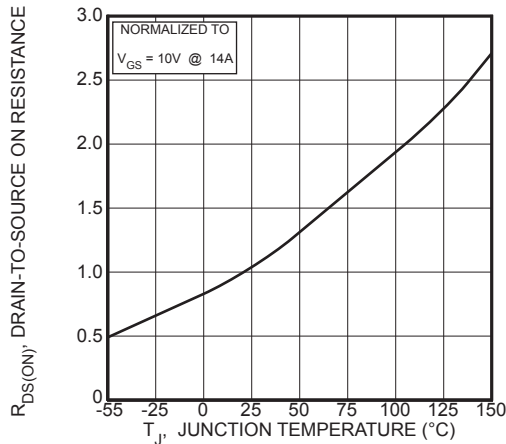

Figure 3, $R_{DS(ON)}$ vs Junction Temperature

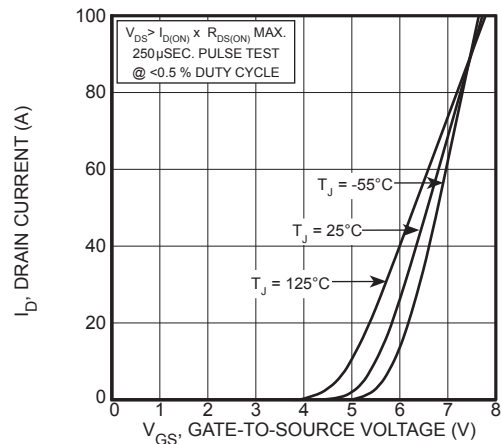

Figure 4, Transfer Characteristics

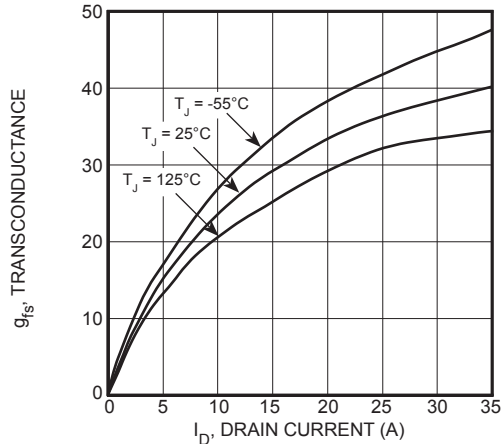

Figure 5, Gain vs Drain Current

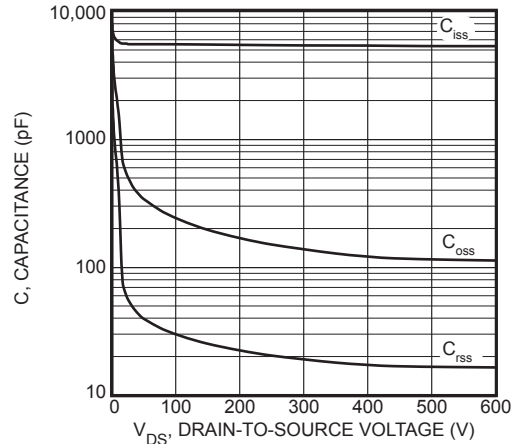

Figure 6, Capacitance vs Drain-to-Source Voltage

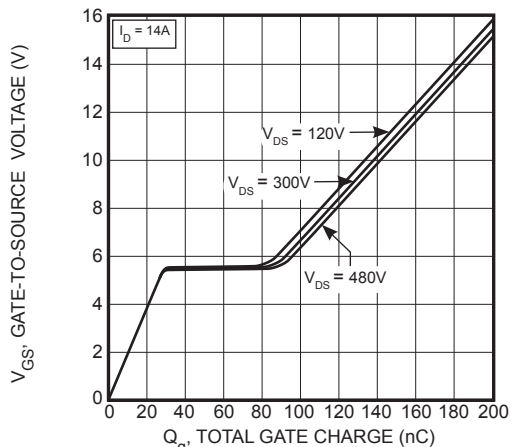

Figure 7, Gate Charge vs Gate-to-Source Voltage

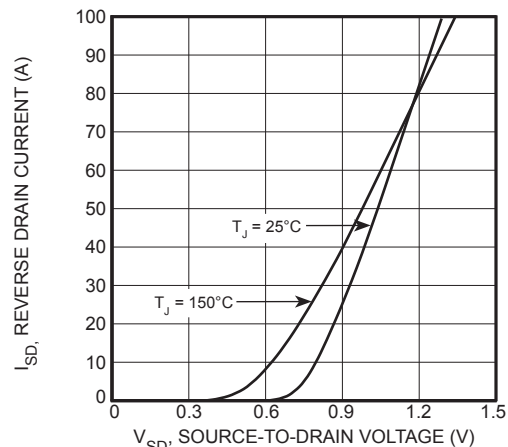

Figure 8, Reverse Drain Current vs Source-to-Drain Voltage

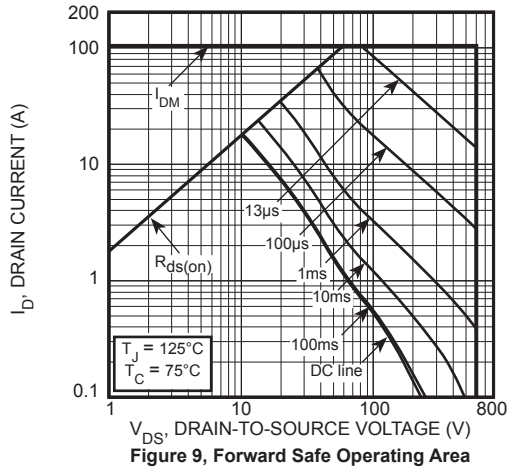

Figure 9, Forward Safe Operating Area

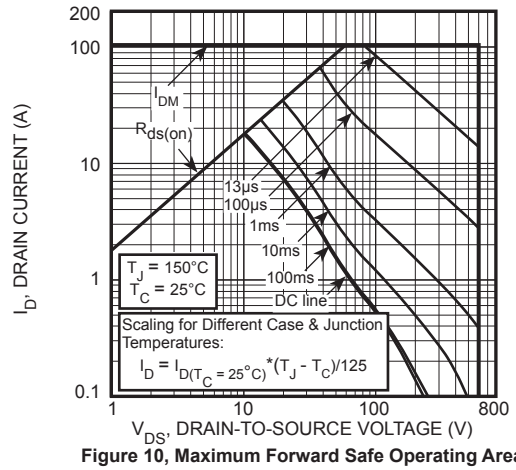

Figure 10, Maximum Forward Safe Operating Area

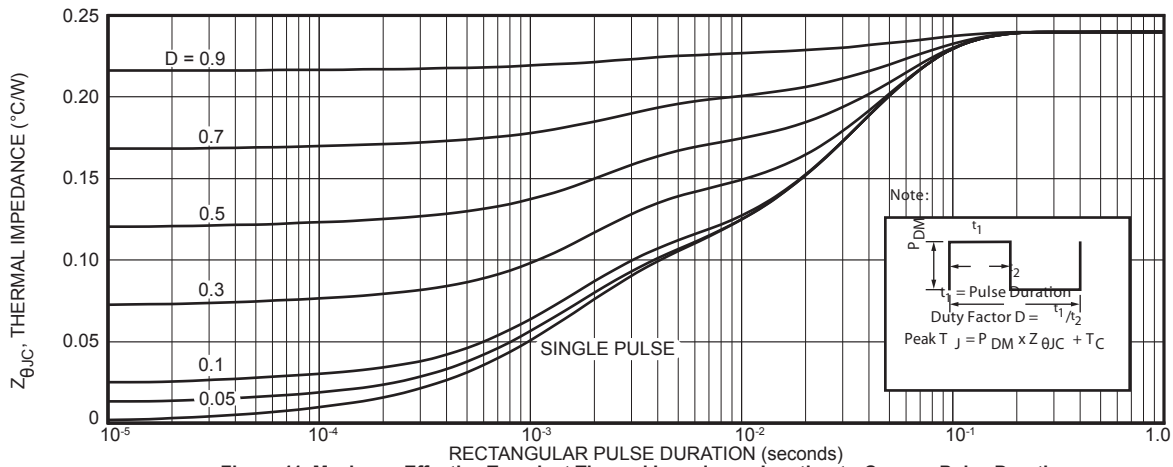
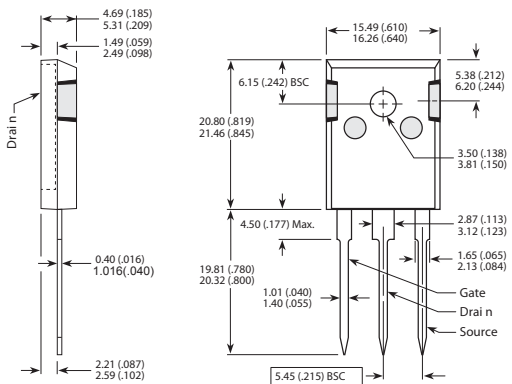

Figure 11. Maximum Effective Transient Thermal Impedance Junction-to-Case vs Pulse Duration

TO-247 (B) Package Outline

e1 SAC: Tin, Silver, Copper



Dimensions in Millimeters (Inches)

D³PAK Package Outline

e3 100% Sn Plated

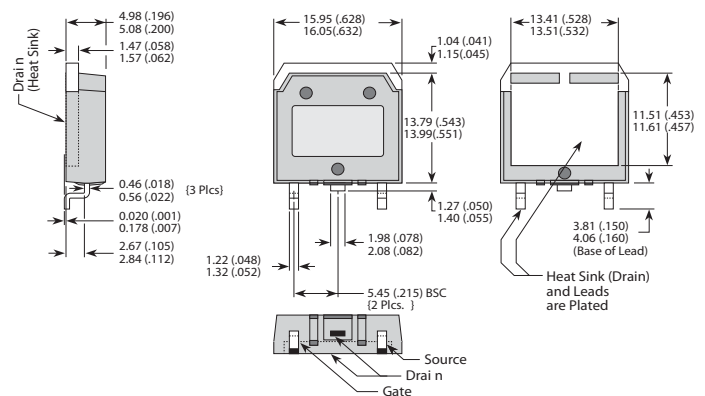

Dimensions in Millimeters (Inches)