



# RFU630-13105

RFU63x

RFID

**SICK**  
Sensor Intelligence.



### Ordering information

Type	Part no.
RFU630-13105	1057943

Other models and accessories → [www.sick.com/RFU63x](http://www.sick.com/RFU63x)



### Detailed technical data

#### Features

<b>Version</b>	Long Range
<b>Product category</b>	Write/read device with integrated antenna
<b>Radio approval</b>	China (800 900 RFID 设备检验标准)
<b>Frequency band</b>	UHF (860 MHz ... 960 MHz)
<b>Carrier frequency</b>	920.625 MHz ... 924.375 MHz
<b>Output power</b>	2 W (ERP, with integrated antenna, alternatively 30 dBm at the external antenna port, output power adjustable)
<b>RFID standard</b>	EPCglobal UHF Class 1 Generation 2, ISO/IEC 18000-6 C
<b>Modulation</b>	PR-ASK, DSB-ASK
<b>MTBF</b>	14 years
<b>Scanning range</b>	Typ. 5 m <sup>1)</sup>
<b>Antenna</b>	Integrated (circular polarized, axial ration typ. 2 dB, 72° field opening, front to back ratio > 17 dB), additionally 3 external antenna ports
<b>Service functions</b>	Parameter cloning with integrated microSD memory card slot or externally via CMC module in CDB620
<b>Further functions</b>	Cloning function (microSD memory card or system), diagnosis, updatable firmware, freely programmable data output format, Heartbeat, triggering, SICK AppSpace functionalities can be enabled with the SD card accessory SDK6U-P00100

<sup>1)</sup> Depending on transponder used and ambient conditions.

#### Interfaces

<b>Ethernet</b>	✓, TCP/IP
Function	Host, AUX
Data transmission rate	10/100 MBit/s
<b>PROFINET</b>	✓
Function	PROFINET Single Port, PROFINET Dual Port (optional via external connection module CDF600-2)

	Data transmission rate	10/100 MBit/s
<b>EtherNet/IP™</b>		✓
	Data transmission rate	10/100 MBit/s
<b>EtherCAT®</b>		✓
	Type of fieldbus integration	Optional over external fieldbus module CDF600
<b>Serial</b>		✓, RS-232, RS-422, RS-485
	Function	Host, AUX
	Data transmission rate	0.3 kBaud ... 115.2 kBaud, AUX: 57.6 kBaud (RS-232)
<b>CAN</b>		✓
	Remark	CSN (SICK CAN Sensor Network)
	Function	Host
<b>PROFIBUS DP</b>		✓
	Type of fieldbus integration	Optional over external fieldbus module CDF600-2
<b>DeviceNet™</b>		✓
	Type of fieldbus integration	Optional available externally
<b>USB</b>		✓
	Remark	USB 2.0
	Function	AUX
<b>Switching inputs</b>		4 ("Sensor 1", "Sensor 2", 2 inputs via optional parameter storage CMC600 in CDB620/CDM420)
<b>Switching outputs</b>		4 ("Result 1", "Result 2", 2 outputs via optional parameter storage CMC600 in CDB620/CDM420)
<b>Optical indicators</b>		8 LEDs, one of them multi-colored (function configurable via SOPAS ET, alternatively controlling with sw commands, status displays)
<b>Acoustic indicators</b>		1 beeper/buzzer (can be switched off, can be allocated as a result indication function)
<b>Operating elements</b>		2 buttons (choose and start/stop functions)
<b>Configuration software</b>		SOPAS ET

## Mechanics/electronics

<b>Electrical connection</b>	1 x M12, 17-pin male connector 1 x M12, 4-pin Ethernet female connector
<b>Operating voltage</b>	18 V DC ... 30 V DC
<b>Power consumption</b>	< 20 W, with switching outputs not connected and full transmit power
<b>Housing</b>	Aluminum die cast
<b>Housing color</b>	Blue, black, silver
<b>Enclosure rating</b>	IP67
<b>Protection class</b>	III
<b>Weight</b>	3.5 kg
<b>Dimensions (L x W x H)</b>	239 mm x 239 mm x 64 mm

## Ambient data

<b>Electromagnetic compatibility (EMC)</b>	EN 61000-6-4 (2007-09) / EN 61000-6-2 (2009-05)
<b>Vibration resistance</b>	EN 60068-2-6 (2008-02)
<b>Shock resistance</b>	EN 60068-2-27 (2009-05)
<b>Ambient operating temperature</b>	-25 °C ... +60 °C

<b>Storage temperature</b>	-30 °C ... +70 °C
<b>Permissible relative humidity</b>	± 90 %, Non-condensing

## Classifications

<b>ECl@ss 5.0</b>	27280401
<b>ECl@ss 5.1.4</b>	27280401
<b>ECl@ss 6.0</b>	27280401
<b>ECl@ss 6.2</b>	27280401
<b>ECl@ss 7.0</b>	27280401
<b>ECl@ss 8.0</b>	27280401
<b>ECl@ss 8.1</b>	27280401
<b>ECl@ss 9.0</b>	27280401
<b>ETIM 6.0</b>	EC002998
<b>UNSPSC 16.0901</b>	52161523

## Dimensional drawing (Dimensions in mm (inch))

RFU63x with antenna

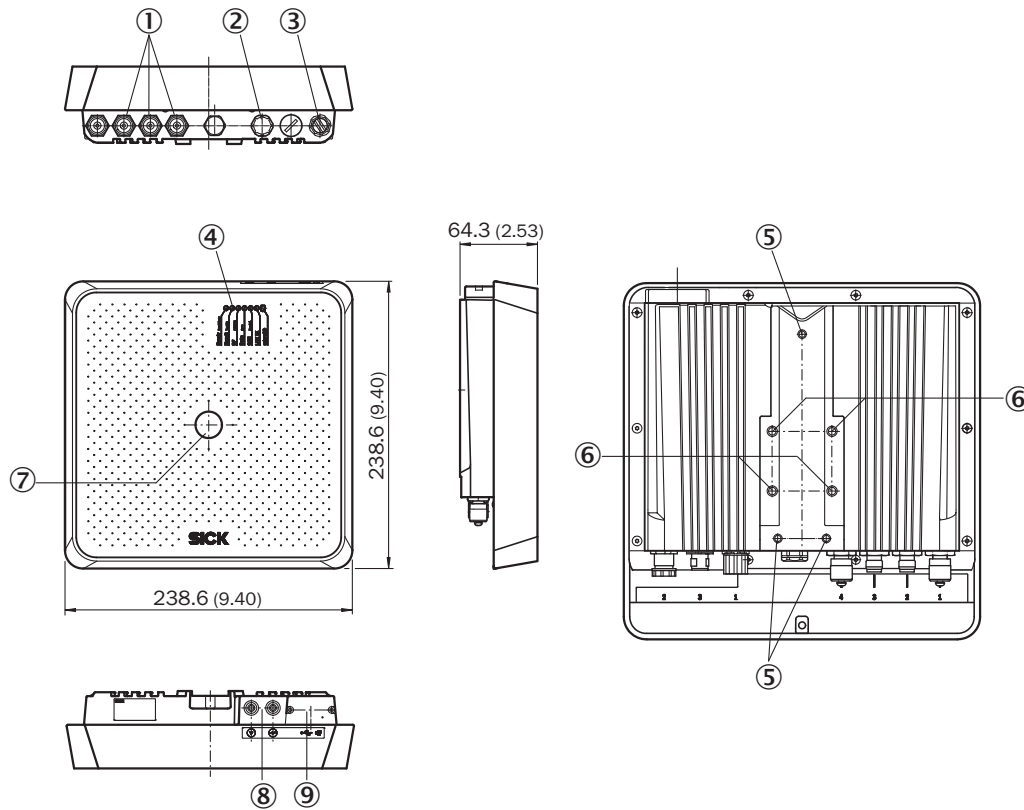



- ① 3 x antenna input ("external", TNC plug, reverse)
- ② "Power/Serial Data/CAN/I/O" connection
- ③ Ethernet connection
- ④ 7 x LED for status display
- ⑤ 3 x M5 threaded mounting holes, 8 mm deep
- ⑥ 4 x M6 threaded mounting holes, 11 mm deep
- ⑦ 1 x LED multi-color (process feedback)
- ⑧ Function buttons
- ⑨ Micro-USB female connector and slot for microSD memory card, behind screw-mounted cover

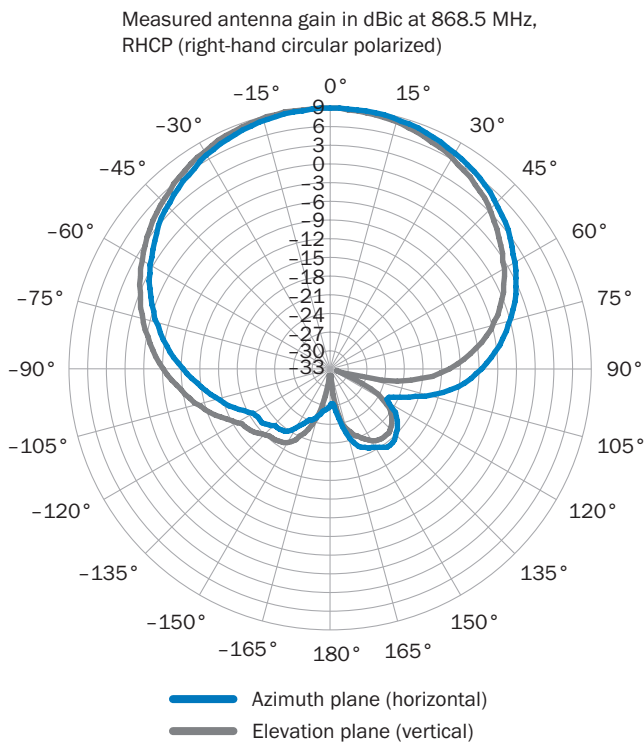



Radiation pattern



Recommended accessories

Other models and accessories → [www.sick.com/RFU63x](http://www.sick.com/RFU63x)

	Brief description	Type	Part no.
<b>Mounting brackets and plates</b>			
	Mounting bracket for wall mounting, incl. assembly material	Mounting bracket	2060912
<b>Modules</b>			
	Connection device basic for connecting one sensor with 2 A fuse, 5 cable glands and RS-232 interface to sensor via M12, 17-pin female connector, all outputs available on screw/spring-loaded terminals.	CDB650-204	1064114
	Fieldbus proxy/gateway for connecting identification sensors to PROFIBUS-DP networks (PROFIBUS interface: 2 x M12, male connector/female connector, 5-pin)	CDF600-2100	1058965
	Fieldbus proxy/gateway for connecting identification sensors to PROFIBUS-DP networks (PROFIBUS interface: 1 x D-Sub, female connector, 9-pin)	CDF600-2103	1058966
	Fieldbus proxy/gateway for connecting one identification sensor to PROFINET-IO networks (interface 2 x M12, female connector/female connector, 4-pin)	CDF600-2200	1062460
<b>Power supply units and power supply cables</b>			
	Power supply unit with pre-assembled M12 female connector, 17-pin, dimensions (L x W x H): 102 mm x 36 mm x 53 mm	Power supply unit	2062249

	Brief description	Type	Part no.
Plug connectors and cables			
	Head A: female connector, M12, 17-pin, straight Head B: male connector, D-Sub-HD, 15-pin, straight Cable: Power, serial, CAN, digital I/Os, shielded, 0.9 m	Connection cable (male connector - female connector)	2049764
	Head A: male connector, M12, 4-pin, straight, D-coded Head B: male connector, RJ45, 8-pin, straight Cable: Ethernet, twisted pair, PUR, halogen-free, shielded, 2 m	SSL-2J04-G02ME	6034414
	Head A: male connector, USB-A Head B: male connector, Micro-B Cable: USB 2.0, unshielded, 2 m	USB cable	6036106
Storage media			
	Code for activating the SICK AppSpace functions. MicroSD memory card with 1 GB for industrial use.	SDK6U-P00100 SICK AppSpace	1076012
RFID transponder			
	UHF transponder, global, thermoplastic, 51.5 mm x 47.5 mm x 10 mm, Impinj Monza 4 QT	On-metal transponder (52 mm x 48 mm x 10 mm)	6052346

## SICK AT A GLANCE

SICK is one of the leading manufacturers of intelligent sensors and sensor solutions for industrial applications. A unique range of products and services creates the perfect basis for controlling processes securely and efficiently, protecting individuals from accidents and preventing damage to the environment.

We have extensive experience in a wide range of industries and understand their processes and requirements. With intelligent sensors, we can deliver exactly what our customers need. In application centers in Europe, Asia and North America, system solutions are tested and optimized in accordance with customer specifications. All this makes us a reliable supplier and development partner.

Comprehensive services complete our offering: SICK LifeTime Services provide support throughout the machine life cycle and ensure safety and productivity.

For us, that is “Sensor Intelligence.”

## WORLDWIDE PRESENCE:

Contacts and other locations –[www.sick.com](http://www.sick.com)