

DFNWB2X2-6L-A Power Management MOSFETS-Schottky

CJLJF3117P P-channel MOSFET and Schottky Barrier Diode

$V_{(BR)DSS}/V_R$	$R_{DS(on)MAX}$	I_D/I_O
-20V	100mΩ@-4.5V	-3.3A
	135mΩ@-2.5V	
	250mΩ@-1.8V	
30V	/	2A

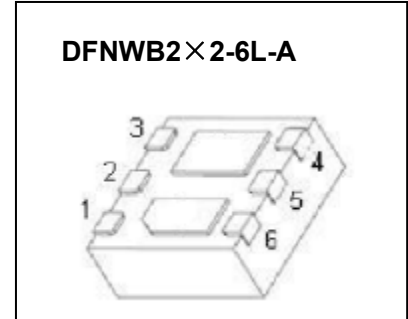

FEATURE

- Independent Pinout to Each Device to Ease Circuit Design
- High Current Schottky Diode

APPLICATION

- Optimized for Portable Applications Like Cell Phones, Digital Cameras, Media Players, etc
- DC-DC Buck Circuits
- Li-ion Battery Applications
- Color Display and Camera Flash Regulators

MARKING

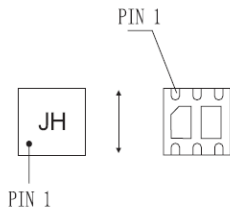

Equivalent Circuit

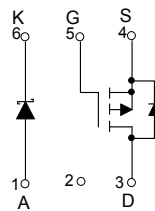

Maximum ratings ($T_a=25^\circ\text{C}$ unless otherwise noted)

Symbol Para	meter	Value	Unit
P-MOSFET			
V_{DS}	Drain-Source Voltage	-20	V
V_{GS}	Gate-Source Voltage	±8	V
I_D	Continuous Drain Current	-3.3	A
I_{DM}^*	Pulse Drain Current	-10	A
Schottky Barrier Diode			
V_{RRM}	Peak Repetitive Reverse Voltage	30	V
V_R	DC Blocking Voltage	30	V
I_O	Average Rectified Forward Current	2	A
Power Dissipation, Temperature and Thermal Resistance			
P_D	Power Dissipation	0.75	W
$R_{\theta JA}$	Thermal Resistance from Junction to Ambient	83.3	$^\circ\text{C}/\text{W}$
T_j	Junction Temperature	150	$^\circ\text{C}$
T_{stg}	Storage Temperature	-55~+150	$^\circ\text{C}$
T_L	Lead Temperature for Soldering Purposes(1/8" from case for 10 s)	260	$^\circ\text{C}$

*Repetitive rating: Pluse width limited by junction temperature.

MOSFET ELECTRICAL CHARACTERISTICS

$T_a=25^\circ\text{C}$ unless otherwise specified

Parameter	Symbol	Test conditions	Min	Typ	Max	Unit
P-MOSFET						
STATIC PARAMETERS						
Drain-source breakdown voltage	$V_{(BR)DSS}$	$V_{GS}=0V, I_D=-250\mu A$	-20			V
Zero gate voltage drain current	I_{DSS}	$V_{DS}=-16V, V_{GS}=0V$			-1	μA
Gate-body leakage current	I_{GSS}	$V_{GS}=\pm 8V, V_{DS}=0V$			± 100	nA
Gate threshold voltage	$V_{GS(th)}$	$V_{DS}=V_{GS}, I_D=-250\mu A$	-0.4	-0.7	-1	V
Drain-source on-resistance(note1)	$R_{DS(on)}$	$V_{GS}=-4.5V, I_D=-2A$		58	100	m Ω
		$V_{GS}=-2.5V, I_D=-2A$		80	135	m Ω
		$V_{GS}=-1.8V, I_D=-1.6A$		120	250	m Ω
Forward transconductance(note1)	g_{FS}	$V_{DS}=-5V, I_D=-2A$	2.5			S
Diode forward voltage(note1)	V_{SD}	$I_S=-1A, V_{GS}=0V$			-1	V
DYNAMIC PARAMETERS (note 2)						
Input capacitance	C_{iss}	$V_{DS}=-10V, V_{GS}=0V, f=1MHz$		531		pF
Output capacitance	C_{oss}			91		pF
Reverse transfer capacitance	C_{rss}			56		pF
SWITCHING PARAMETERS (note 2)						
Turn-on delay time	$t_{d(on)}$	$V_{GS}=-4.5V, V_{DD}=-5V,$ $R_G=6\Omega, I_D=-1A$		5.2		ns
Turn-on rise time	t_r			13.2		ns
Turn-off delay time	$t_{d(off)}$			13.7		ns
Turn-off fall time	t_f			19.1		ns
Total Gate Charge	Q_g	$V_{DS}=-10V, V_{GS}=-4.5V,$ $I_D=-2A$		5.5	6.2	nC
Gate-Source Charge	Q_{gs}			1.0		nC
Gate-Drain Charge	Q_{gd}			1.4		nC
Gate Resistance	R_g			8.8		Ω
SCHOTTKY BARRIER DIODE						
Forward voltage	V_F	$I_F=0.1A$			0.39	V
		$I_F=1A$			0.55	V
Reverse current	I_R	$V_R=30V$			20	μA
		$V_R=20V$			8	μA
		$V_R=10V$			4.5	μA
Junction capacitance	C_j	$V_R=5V, f=1MHz$		30		pF

Note:

- 1.Pulse test: pulse width =300 μs , duty cycle $\leq 2\%$
- 2.These parameters have no way to verify.

Typical Characteristics

P-channel Characteristics

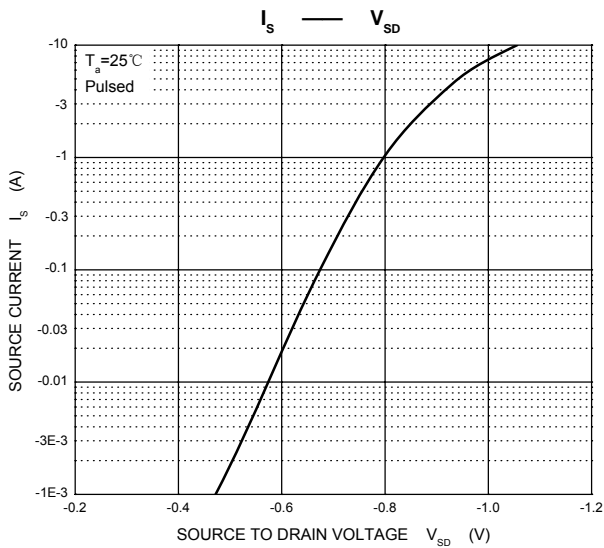
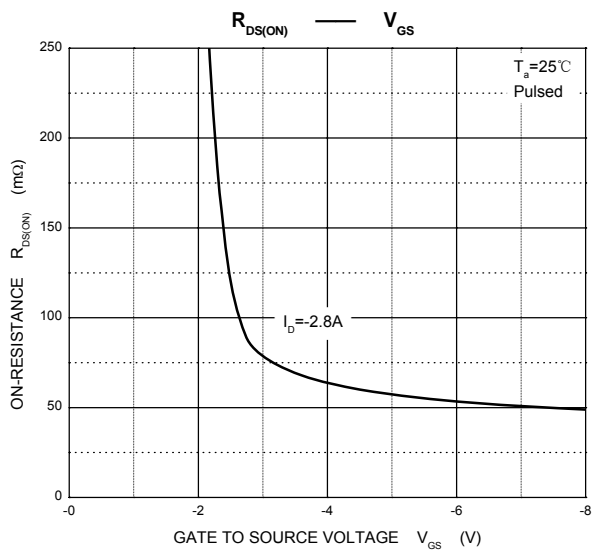
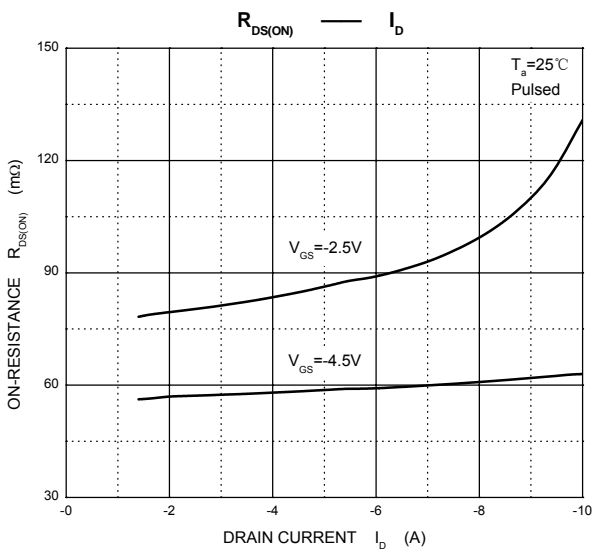
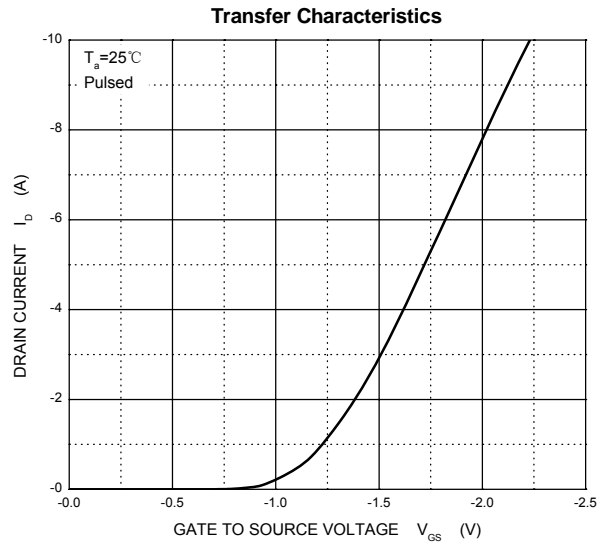
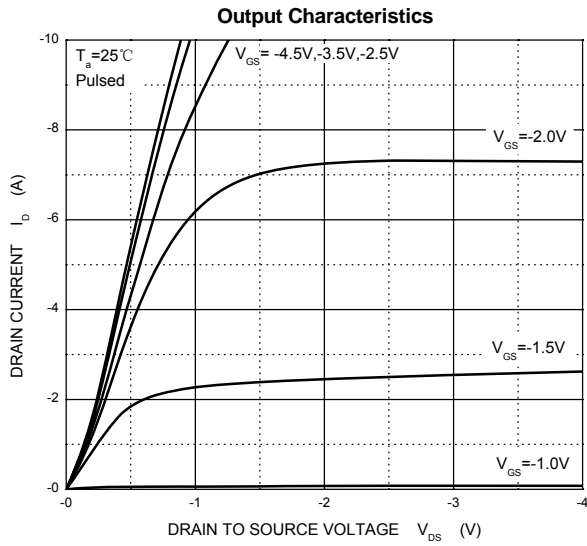

Typical Characteristics

Schottky Characteristics

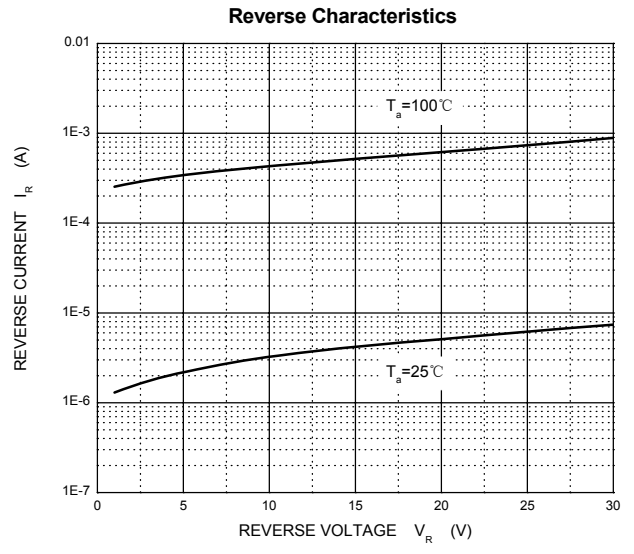
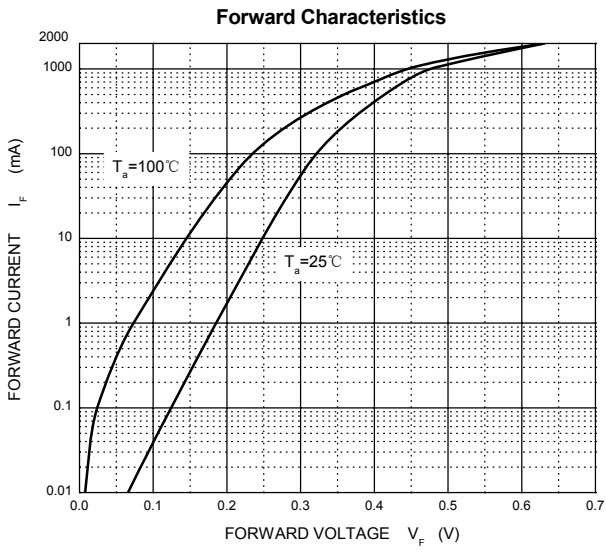

DFNWB2X2-6L-A Package Outline Dimensions

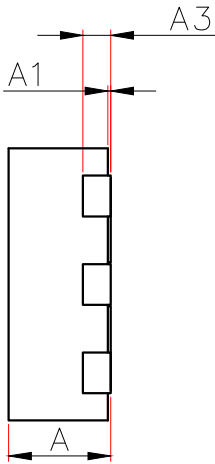
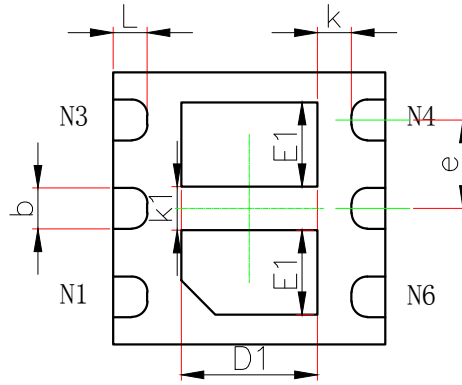
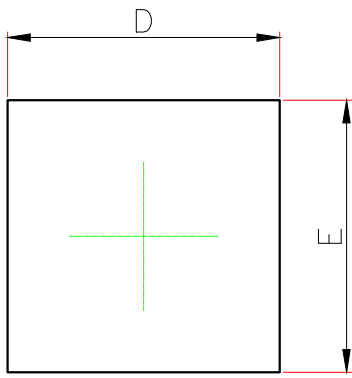

Symbol	Dimensions In Millimeters		Dimensions In Inches	
	MIN.	MAX.	MIN.	MAX.
A	0.700	0.800	0.028	0.031
A1	0.000	0.050	0.000	0.002
A3	0.203REF.		0.008REF.	
D	1.900	2.100	0.075	0.083
E	1.900	2.100	0.075	0.083
D1	0.900	1.100	0.035	0.043
E1	0.520	0.720	0.020	0.028
b	0.250	0.350	0.010	0.014
e	0.650TYP.		0.026TYP.	
k	0.200MIN.		0.008MIN.	
k1	0.320REF.		0.013REF.	
L	0.200	0.300	0.008	0.012

DFNWB2X2-6L-A Suggested Pad Layout

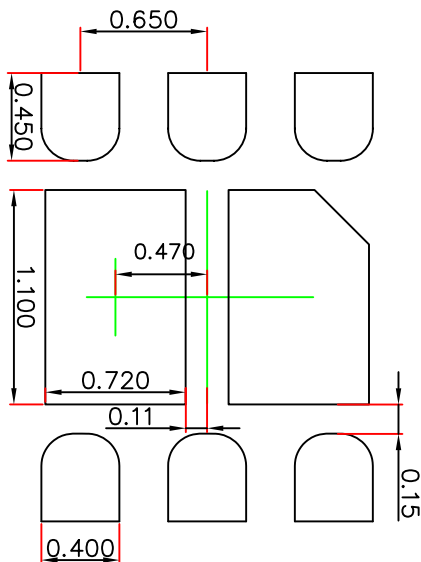

Note:

1. Controlling dimension: in millimeters.
2. General tolerance: ± 0.050 mm.
3. The pad layout is for reference purposes only.

NOTICE

JCET reserve the right to make modifications, enhancements, improvements, corrections or other changes without further notice to any product herein. JCET does not assume any liability arising out of the application or use of any product described herein.

DFNWB2X2-6L Tape and Reel

DFNWB2×2-6L Embossed Carrier Tape

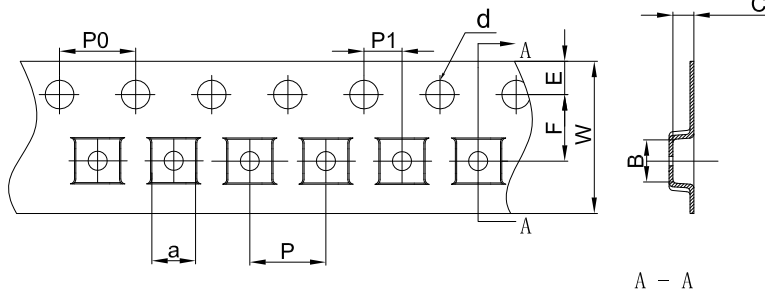

Packaging Description:

DFNWB2×2-6L parts are shipped in tape. The carrier tape is made from a dissipative (carbon filled) polycarbonate resin. The cover tape is a multilayer film (Heat Activated Adhesive in nature) primarily composed of polyester film, adhesive layer, sealant, and anti-static sprayed agent. These reeled parts in standard option are shipped with 3,000 units per 7" or 18.0cm diameter reel. The reels are clear in color and is made of polystyrene plastic (anti-static coated).

Dimensions are in millimeter

Pkg type	a	B	C	d	E	F	P0	P	P1	W
DFNWB2×2-6L	2.30	2.30	1.10	Ø1.50	1.75	3.50	4.00	4.00	2.00	8.00

DFNWB2×2-6L Tape Leader and Trailer

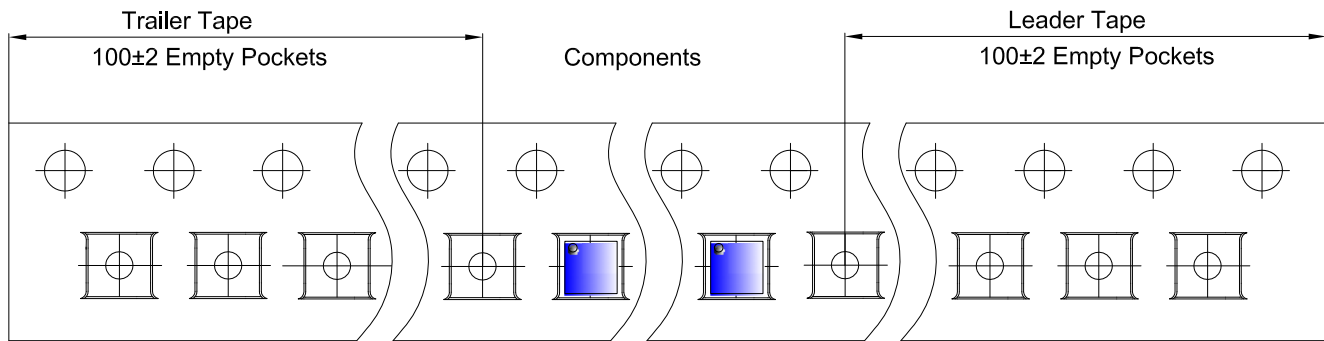

DFNWB2×2-6L Reel

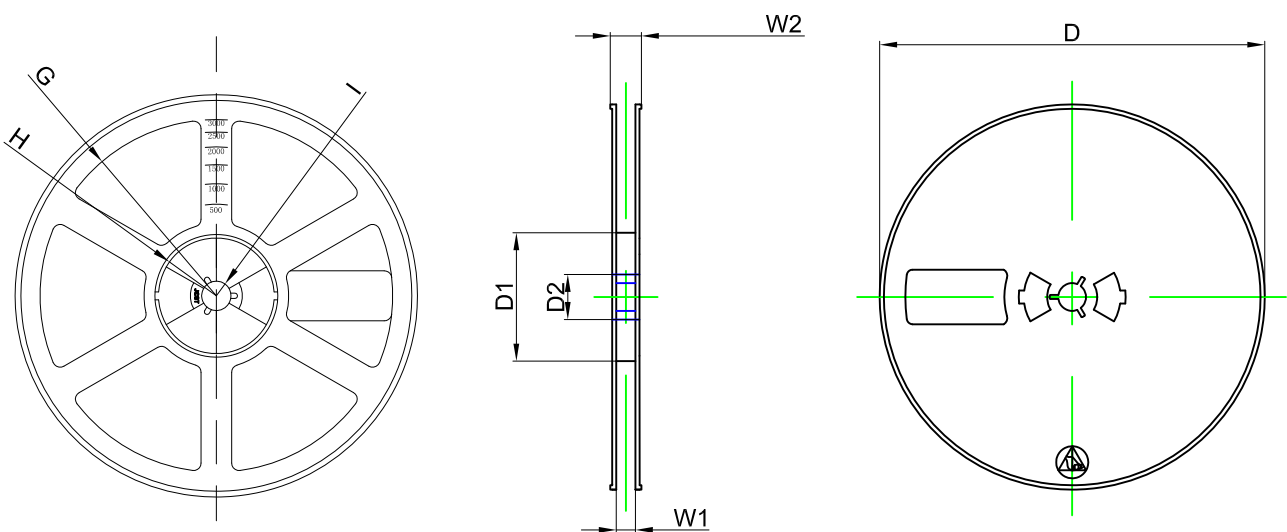

Dimensions are in millimeter

Reel Option	D	D1	D2	G	H	I	W1	W2
7"Dia	Ø180.00	60.00	13.00	R78.00	R25.60	R6.50	9.50	13.10

REEL	Reel Size	Box	Box Size(mm)	Carton	Carton Size(mm)	G.W.(kg)
3000 pcs	7 inch	30,000 pcs	203×203×195	120,000 pcs	438×438×220	