

Description

The plerow™ PLL synthesizer module was designed for use in wireless and wire-line systems in a wide range of frequency from 50 MHz to 6 GHz. ASB's PLL provides exceptionally low spurious and phase noise performance with fast locking time and low current consumption. All products are available in a surface-mount type package.



Specifications

Parameter	Unit	Min.	Typical	Max.
Frequency Range	MHz		2032.5	
Output Power	dBm		3	
Supply Voltage	V		5	
Current Consumption	mA		30	
2 nd Harmonics	dBc		-25	
Spurious Level	dBc		-65	
Reference Frequency	MHz		10	
Reference Input Level	dBm		0	
Phase Noise (C / N)				
@ 1 kHz			-80	
@ 10 kHz	dBc/Hz		-95	
@ 100 kHz			-115	
Output Impedance	Ω		50	
Operating Temp. Range	°C	-40	25	85
Package Type & Size	mm	SMT, 12.7W×12.7L×3H		

1) Measurement conditions are as follows: T = 25°C, V_{CC} = 5 V, Freq. = 2032.5 MHz, 50 ohm system.

2) The phase noise tolerance could be within +/- 2 dBc/Hz depending upon the noise applied to PLL from the dc power supplier.

More Information

Website: www.asb.co.kr
E-mail: sales@asb.co.kr

Tel: (82) 42-528-7220
Fax: (82) 42-528-7222

ASB Inc., 44-14, Techno 10-ro,
Yuseong-gu Daejeon, 305-510,
Korea

Outline Drawing

Type	Dimension
PLL IC + VCO + ROM	12.7 x 12.7 x 3

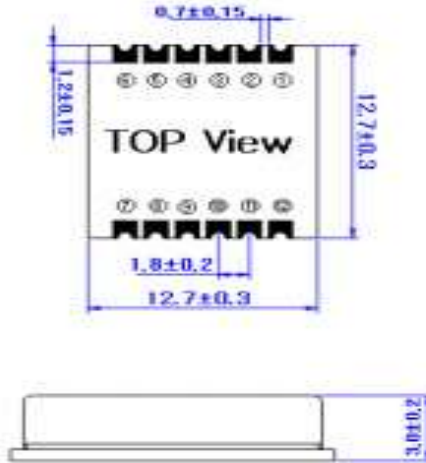

Pin Out for PLL			
Pin No.	Application	Pin No.	Application
1	GROUND	7	VCC (VCO)
2	GROUND	9	RF OUT
3	GROUND	11	VCC (PLL)
4	OSC IN	12	LOCK DETECT
All other Pins are Grounded / Internal ROM			

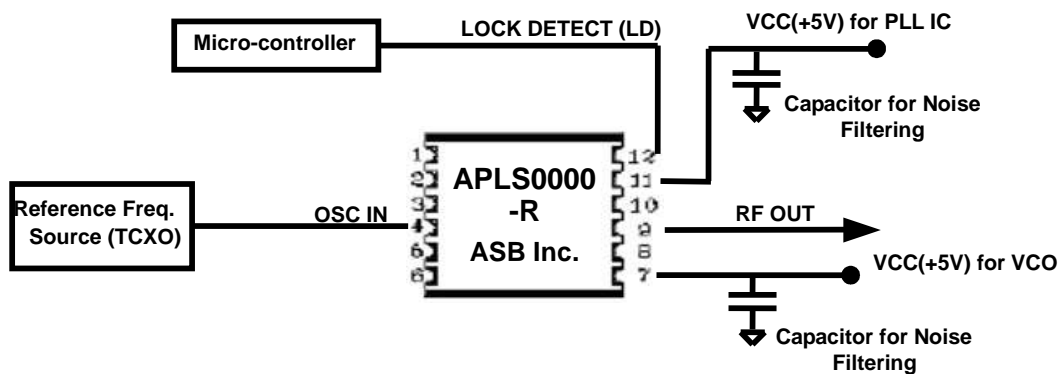

Copyright ©2006-2017 ASB Inc. All rights reserved. Datasheet subject to change without notice. ASB assumes no responsibility for any errors which may appear in this datasheet. No part of the datasheet may be copied or reproduced in any form or by any means without the prior written consent of ASB.