

RJ45 10/100 Base-T Jack with Magnetic Module

ARJ11B

RoHS
Compliant



16.26 x 13.84 x 21.59mm

FEATURES:

- Excellent EMI suppression
- Meet IEEE 802.3 standards and FCC mechanical requirements
- Low Cost, RoHS Compliant Reflow-able device

APPLICATIONS:

- LAN-on-Motherboard (LOM)
- SOHO (ADSL modems), Hubs.
- Suitable for CAT 5 & 6 Fast Ethernet Cable or better UTP

STANDARD SPECIFICATIONS:

Operating Temperature: - 0°C to + 70°C
Storage Temperature: - 40°C to +85°C

Part Number	Turns Ratio ±5%		EMI Fingers	LED (L/R)	Insertion Loss (dB max)
	TX	RX			0.3-100 MHz
ARJ11B-MASAA-MU2 to ARJ11B-MASAI-MU2	1CT:1CT	1CT:1CT	YES	---	-1
ARJ11B-MASAJ-MU2 to ARJ11B-MASAM-MU2	1CT:1CT	1CT:1CT	YES	---	-1
ARJ11B-MASAN-LU2 to ARJ11B-MASBF-LU2	1CT:1	1CT:1CT	YES	---	-1
ARJ11B-MESCB-A-B-ELT2	1CT:1	1CT:1	NO	G/Y	-1
ARJ11B-MASCB-LT2	1CT:1	1CT:1	YES	---	-1
ARJ11B-MBSCB-A-B-ELT2	1CT:1	1CT:1	YES	G/Y	-1
ARJ11B-MDSBQ-MU2	1CT:1CT	1CT:1CT	NO	---	-1
ARJ11B-MESBQ-A-B-EMU2	1CT:1CT	1CT:1CT	NO	G/Y	-1
ARJ11B-MASBQ-MU2	1CT:1CT	1CT:1CT	YES	---	-1
ARJ11B-MBSBQ-A-B-EMU2	1CT:1CT	1CT:1CT	YES	G/Y	-1
ARJ11B-MFSBQ-A-A-EMU2	1CT:1CT	1CT:1CT	YES	G/G	-1
ARJ11B-MASAJ-MU2	1CT:1CT	1CT:1CT	YES	---	-1
ARJ11B-MASBR-QU2	1CT:1.414CT	1CT:1CT	YES	---	-1
ARJ11B-MFSBR-A-A-EQU2	1CT:1.414CT	1CT:1CT	YES	G/G	-1
ARJ11B-MDSAO-LU2	1CT:1	1CT:1CT	NO	---	-1
ARJ11B-MESAO-A-B-ELU2	1CT:1	1CT:1CT	NO	G/Y	-1
ARJ11B-MESAO-A-A-ELU2	1CT:1	1CT:1CT	NO	G/G	-1
ARJ11B-MASAO-LU2	1CT:1	1CT:1CT	YES	---	-1
ARJ11B-MBSAO-A-B-ELU2	1CT:1	1CT:1CT	YES	G/Y	-1
ARJ11B-MFSAO-A-A-ELU2	1CT:1	1CT:1CT	YES	G/G	-1
ARJ11B-MFSAO-BA-A-GLU2	1CT:1	1CT:1CT	YES	YG/G	-1
ARJ11B-MBSAP-A-B-ELU2	1CT:1	1CT:1CT	YES	G/Y	-1
ARJ11B-MASAC-MU2	1CT:1CT	1CT:1CT	YES	---	-1
ARJ11B-MASAD-OW2	1CT:1.41CT	1CT:1.41CT	YES	---	---
ARJ11B-MBSAI-A-B-EMU2	1CT:1CT	1CT:1CT	YES	G/Y	-1
ARJ11B-MASCC-MU2	1CT:1CT	1CT:1CT	YES	---	-1
ARJ11B-MESBW-B-A-EMU2	1CT:1CT	1CT:1CT	NO	Y/G	-1

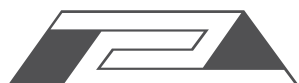

RJ45 10/100 Base-T Jack with Magnetic Module

ARJ11B

RoHS
Compliant



16.26 x 13.84 x 21.59mm

STANDARD SPECIFICATIONS: 25°C (contd)

Part Number	Return Loss (dB min @ 100Ω±15Ω)				Crosstalk (dB min)			Common Mode Rejection (dB min)			Hipot (Vrms)
	1-30 MHz	40 MHz	50 MHz	60-80 MHz	30 MHz	60 MHz	100 MHz	30 MHz	60 MHz	100 MHz	
ARJ11B-MASAA-MU2 to ARJ11B-MASAI-MU2	-18	-16	-14	-12	-45	-40	-35	-35	-30	-25	1500
ARJ11B-MASAJ-MU2 to ARJ11B-MASAM-MU2	-18	-16	-14	-12	-45	-40	-35	-35	-30	-25	1500
ARJ11B-MASAN-LU2 to ARJ11B-MASBF-LU2	-18	-16	-14	-12	-45	-40	-35	-35	-30	-25	1500
ARJ11B-MESCB-A-B-ELT2	-18	-16	-12	-10	-40	-35	-30	-30	-20	-20	1500
ARJ11B-MASCB-LT2	-18	-16	-12	-10	-40	-35	-30	-30	-20	-20	1500
ARJ11B-MBSCB-A-B-ELT2	-18	-16	-12	-10	-40	-35	-30	-30	-20	-20	1500
ARJ11B-MDSBQ-MU2	-18	-16	-12	-10	-40	-35	-30	-30	-20	-20	1500
ARJ11B-MESBQ-A-B-EMU2	-18	-16	-12	-10	-40	-35	-30	-30	-20	-20	1500
ARJ11B-MASBQ-MU2	-18	-16	-12	-10	-40	-35	-30	-30	-20	-20	1500
ARJ11B-MBSBQ-A-B-EMU2	-18	-16	-12	-10	-40	-35	-30	-30	-20	-20	1500
ARJ11B-MFSBQ-A-A-EMU2	-18	-16	-12	-10	-40	-35	-30	-30	-20	-20	1500
ARJ11B-MASAJ-MU2	-18	-16	-12	-10	-40	-35	-30	-30	-20	-20	1500
ARJ11B-MASBR-QU2	-18	-16	-12	-10	-40	-35	-30	-30	-20	-20	1500
ARJ11B-MFSBR-A-A-EQU2	-18	-16	-12	-10	-40	-35	-30	-30	-20	-20	1500
ARJ11B-MDSAO-LU2	-18	-16	-12	-10	-40	-35	-30	-30	-20	-20	1500
ARJ11B-MESAO-A-B-ELU2	-18	-16	-12	-10	-40	-35	-30	-30	-20	-20	1500
ARJ11B-MESAO-A-A-ELU2	-18	-16	-12	-10	-40	-35	-30	-30	-20	-20	1500
ARJ11B-MASAO-LU2	-18	-16	-12	-10	-40	-35	-30	-30	-20	-20	1500
ARJ11B-MBSAO-A-B-ELU2	-18	-16	-12	-10	-40	-35	-30	-30	-20	-20	1500
ARJ11B-MFSAO-A-A-ELU2	-18	-16	-12	-10	-40	-35	-30	-30	-20	-20	1500
ARJ11B-MFSAO-BA-A-GLU2	-18	-16	-12	-10	-40	-35	-30	-30	-20	-20	1500
ARJ11B-MBSAP-A-B-ELU2	-18	-16	-12	-10	-40	-35	-30	-30	-20	-20	1500
ARJ11B-MASAC-MU2	-18	-16	-12	-10	-40	-35	-30	-30	-20	-20	1500
ARJ11B-MASAD-OW2	--	--	--	--	-40	-35	-30	-30	-20	-20	1500
ARJ11B-MBSAI-A-B-EMU2	-18	-16	-12	-10	-40	-35	-30	-30	-20	-20	1500
ARJ11B-MASCC-MU2	-18	-16	-12	-10	-40	-35	-30	-30	-20	-20	1500
ARJ11B-MESBW-B-A-EMU2	-18	-16	-12	-10	-40	-35	-30	-30	-20	-20	1500

Contact Abracon for more custom configurations. See options to build a custom configuration.

OPTIONS & PART IDENTIFICATION:

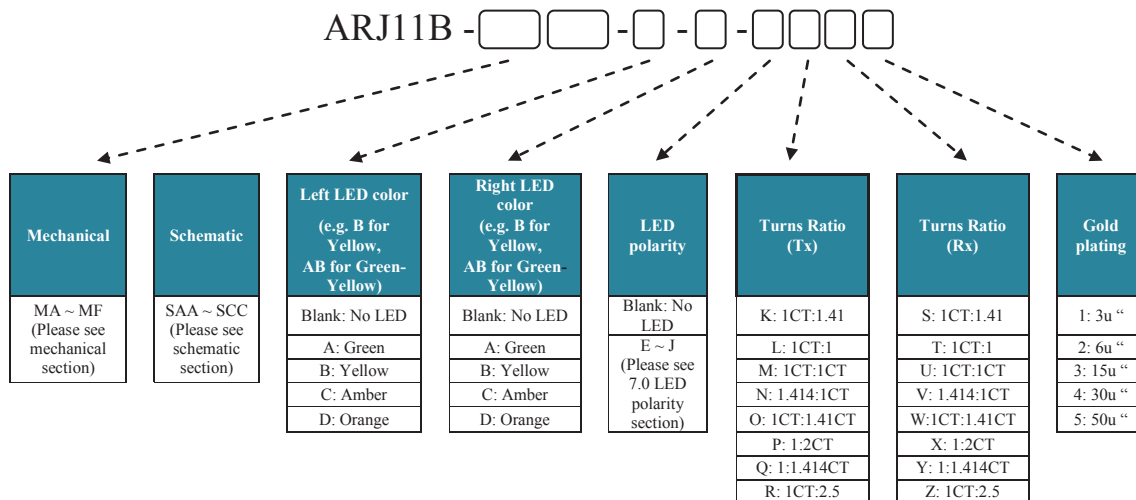

ABRACON IS
ISO 9001:2008
CERTIFIED



ABRACON
CORPORATION

Visit www.abracon.com for Terms & Conditions of Sale
30332 Esperanza, Rancho Santa Margarita, California 92688
tel 949-546-8000 | fax 949-546-8001 | www.abracon.com

Revised: 04.21.11

RJ45 10/100 Base-T Jack with Magnetic Module

ARJ11B

RoHS
Compliant



16.26 x 13.84 x 21.59mm

SCHEMATICS

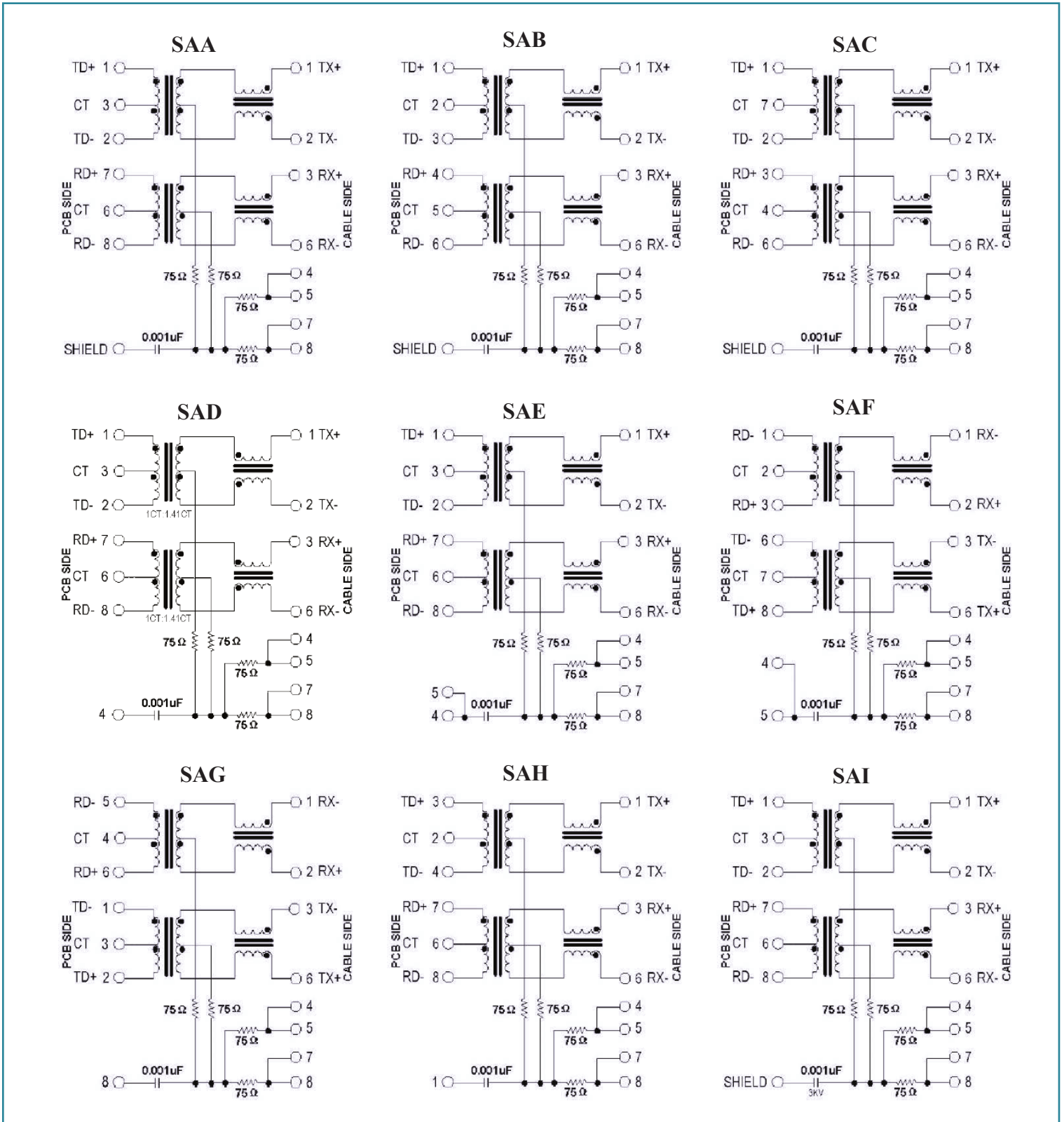

ABRACON IS
ISO 9001:2008
CERTIFIED



ABRACON
CORPORATION

Visit www.abracon.com for Terms & Conditions of Sale
30332 Esperanza, Rancho Santa Margarita, California 92688
tel 949-546-8000 | fax 949-546-8001 | www.abracon.com

Revised: 04.21.11

RJ45 10/100 Base-T Jack with Magnetic Module

ARJ11B

RoHS
Compliant



16.26 x 13.84 x 21.59mm

SCHEMATICS

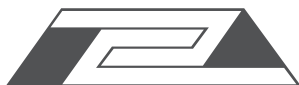
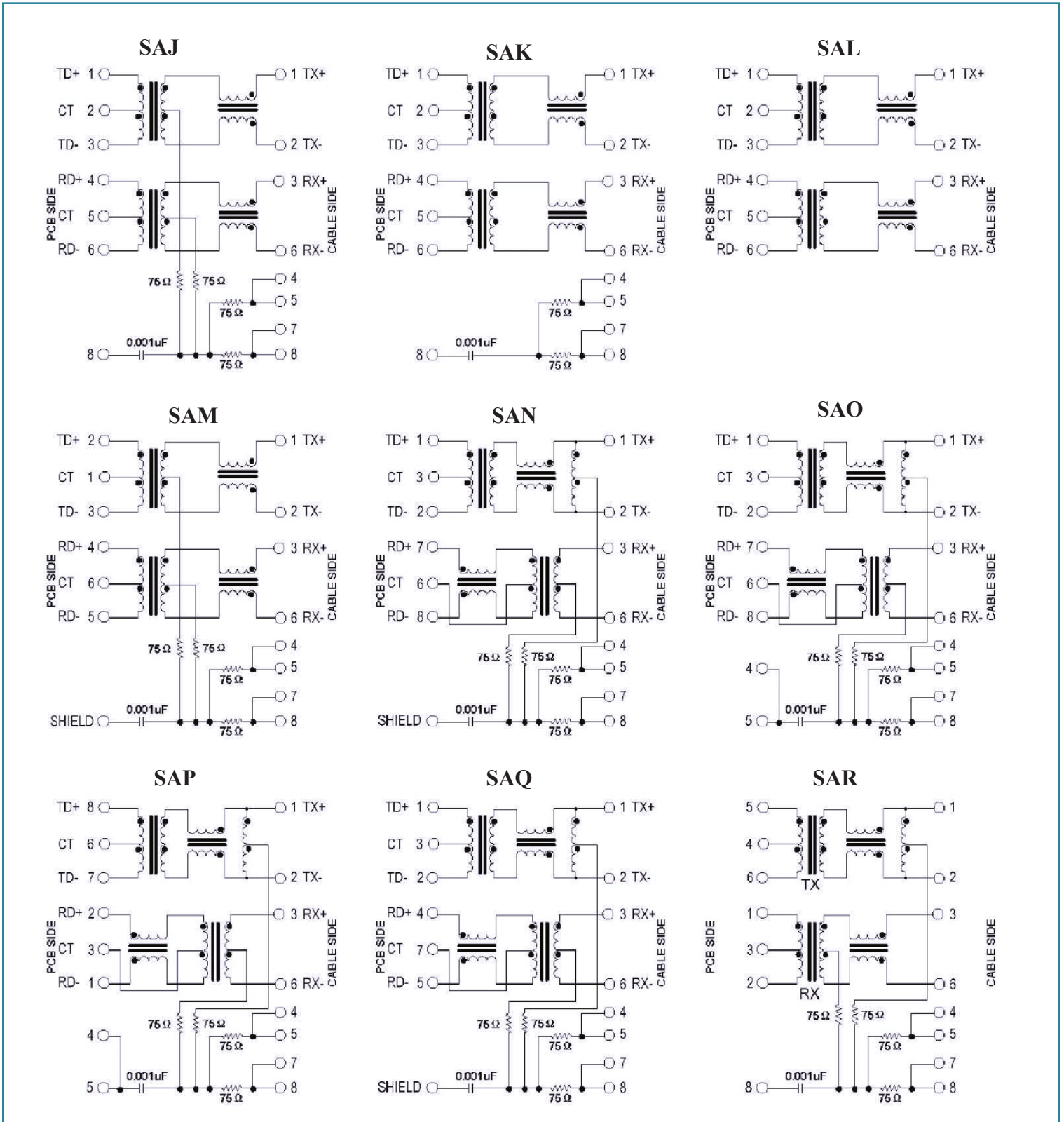

RJ45 10/100 Base-T Jack with Magnetic Module

ARJ11B

RoHS
Compliant



16.26 x 13.84 x 21.59mm

SCHEMATICS

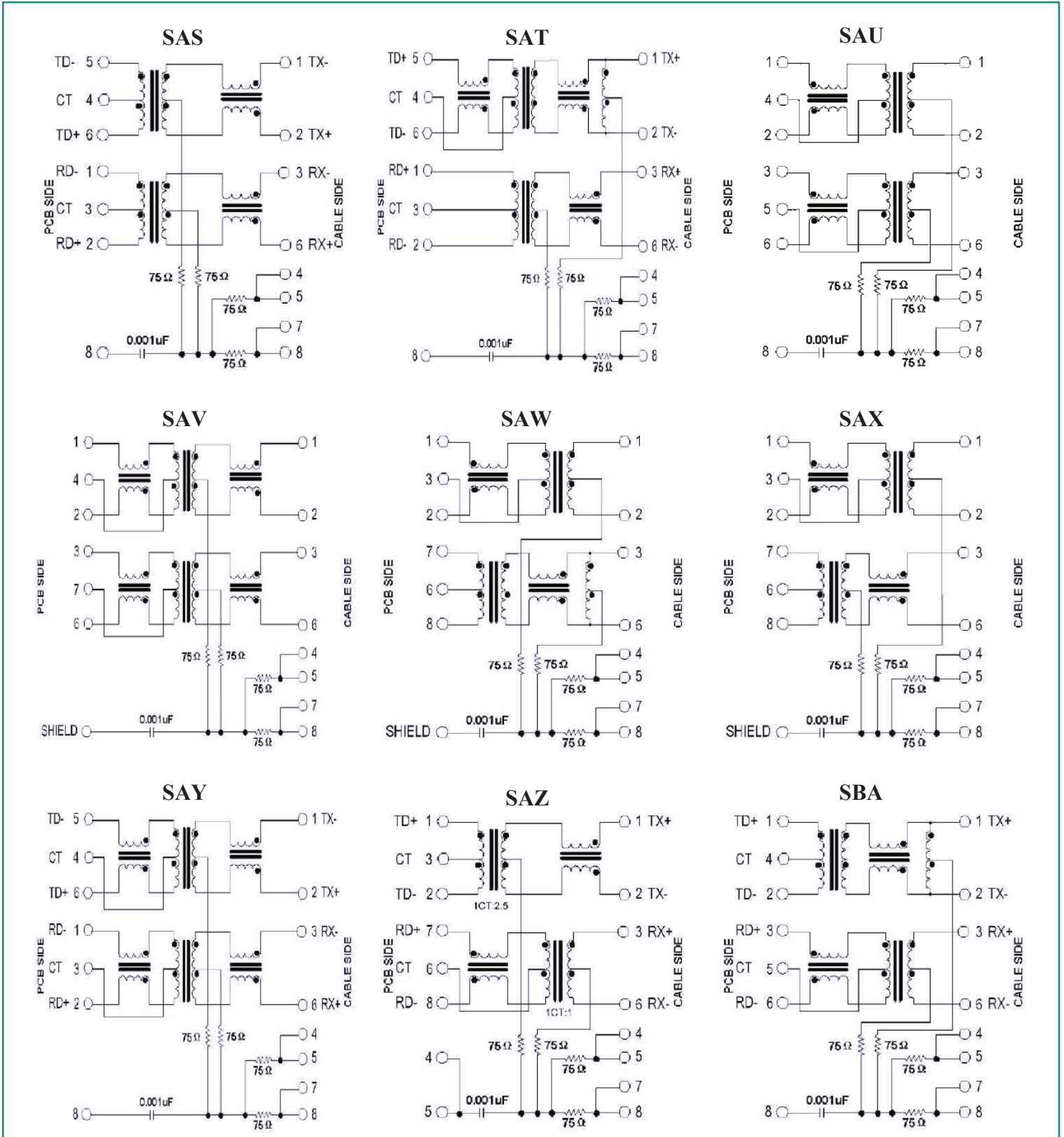

ABRACON IS
ISO 9001:2008
CERTIFIED

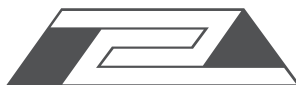

ABRACON
CORPORATION

Visit www.abracon.com for Terms & Conditions of Sale
30332 Esperanza, Rancho Santa Margarita, California 92688
tel 949-546-8000 | fax 949-546-8001 | www.abracon.com

Revised: 04.21.11

RJ45 10/100 Base-T Jack with Magnetic Module

ARJ11B

RoHS
Compliant



16.26 x 13.84 x 21.59mm

SCHEMATICS

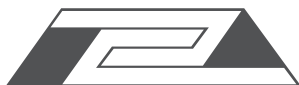
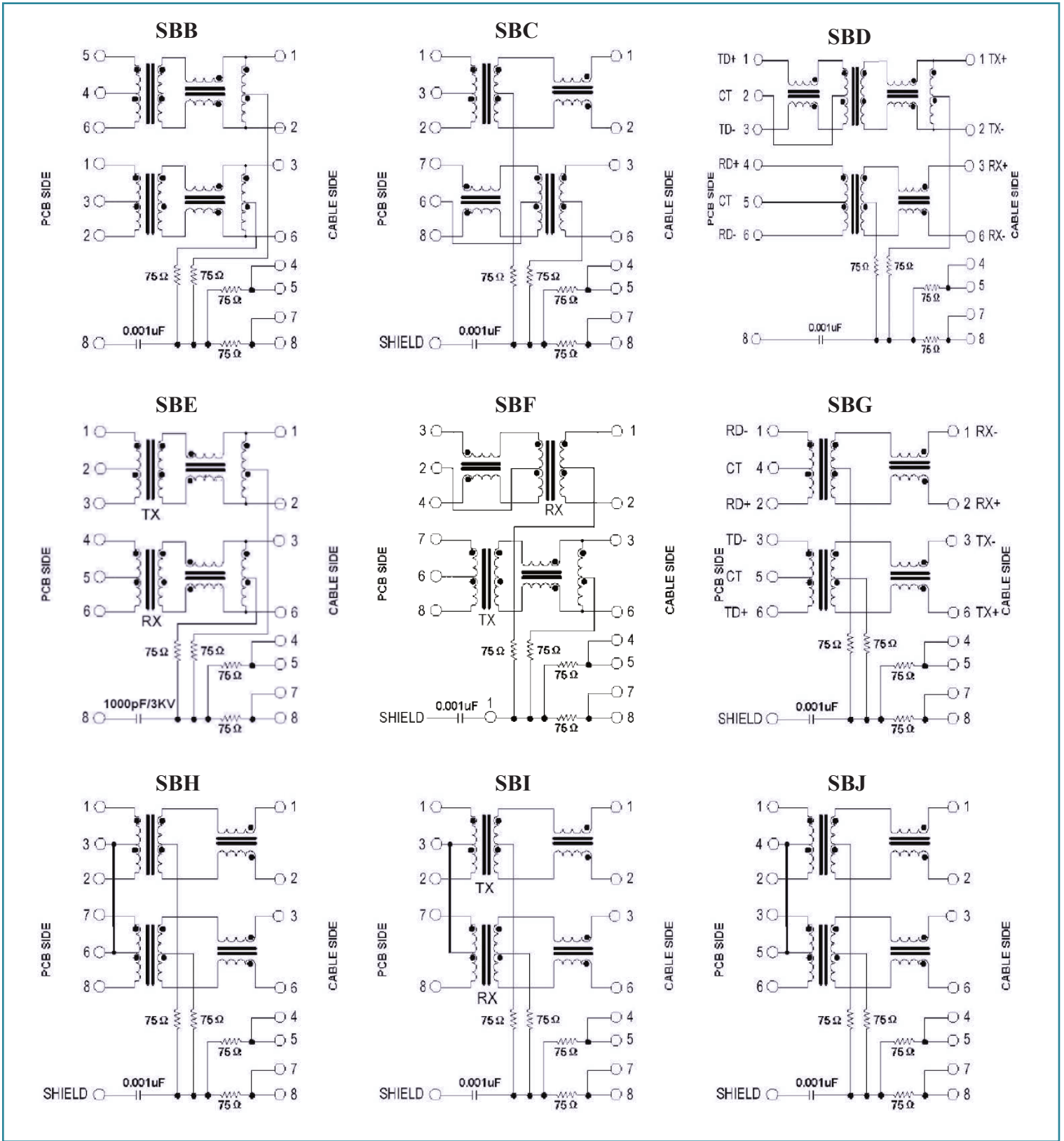

RJ45 10/100 Base-T Jack with Magnetic Module



16.26 x 13.84 x 21.59mm

ARJ11B

RoHS
Compliant

SCHEMATICS

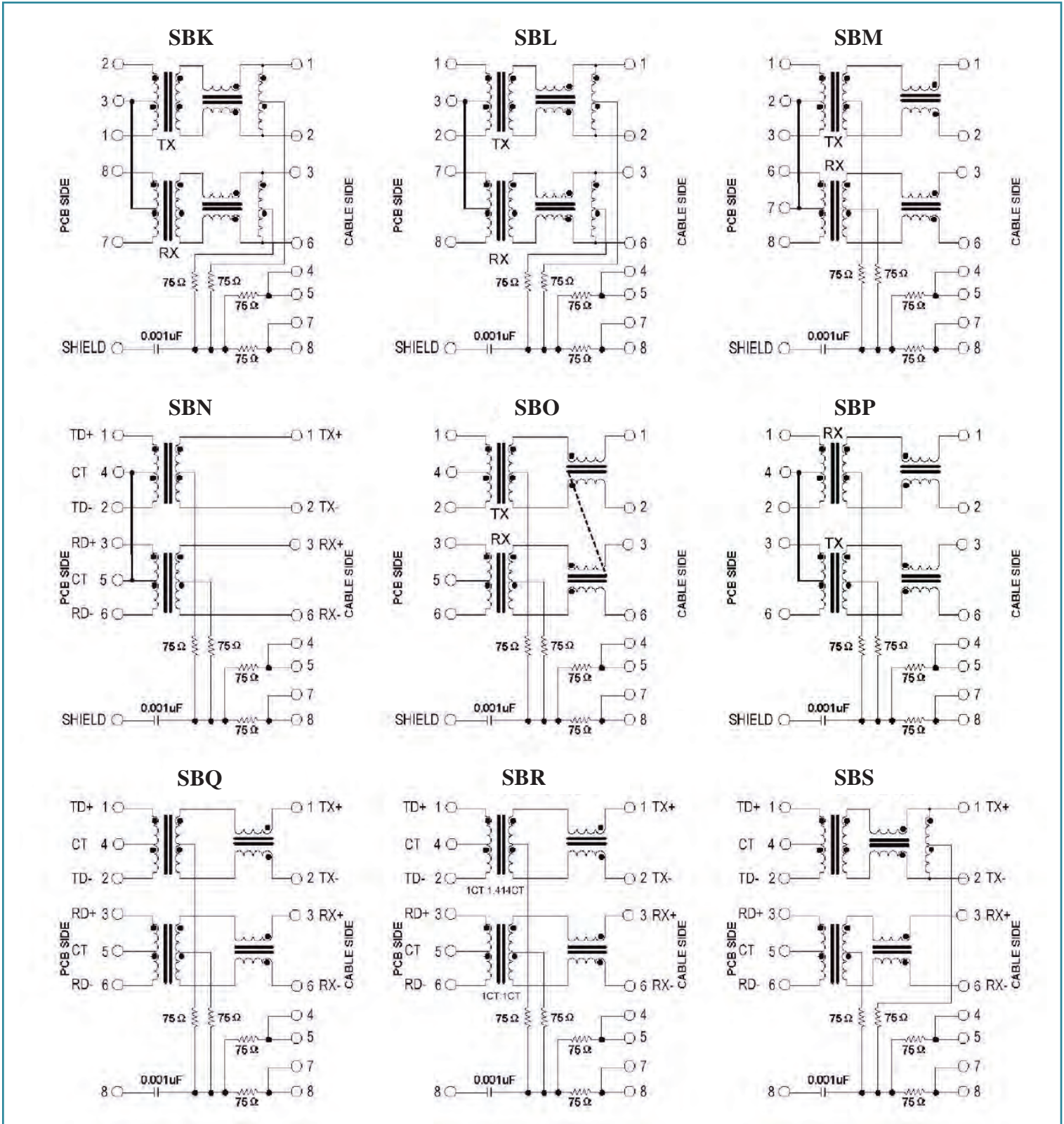

ABRACON IS
ISO 9001:2008
CERTIFIED

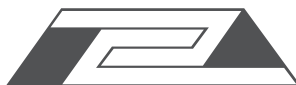

ABRACON
CORPORATION

Visit www.abracon.com for Terms & Conditions of Sale
30332 Esperanza, Rancho Santa Margarita, California 92688
tel 949-546-8000 | fax 949-546-8001 | www.abracon.com

Revised: 04.21.11

RJ45 10/100 Base-T Jack with Magnetic Module

ARJ11B

RoHS
Compliant



16.26 x 13.84 x 21.59mm

SCHEMATICS

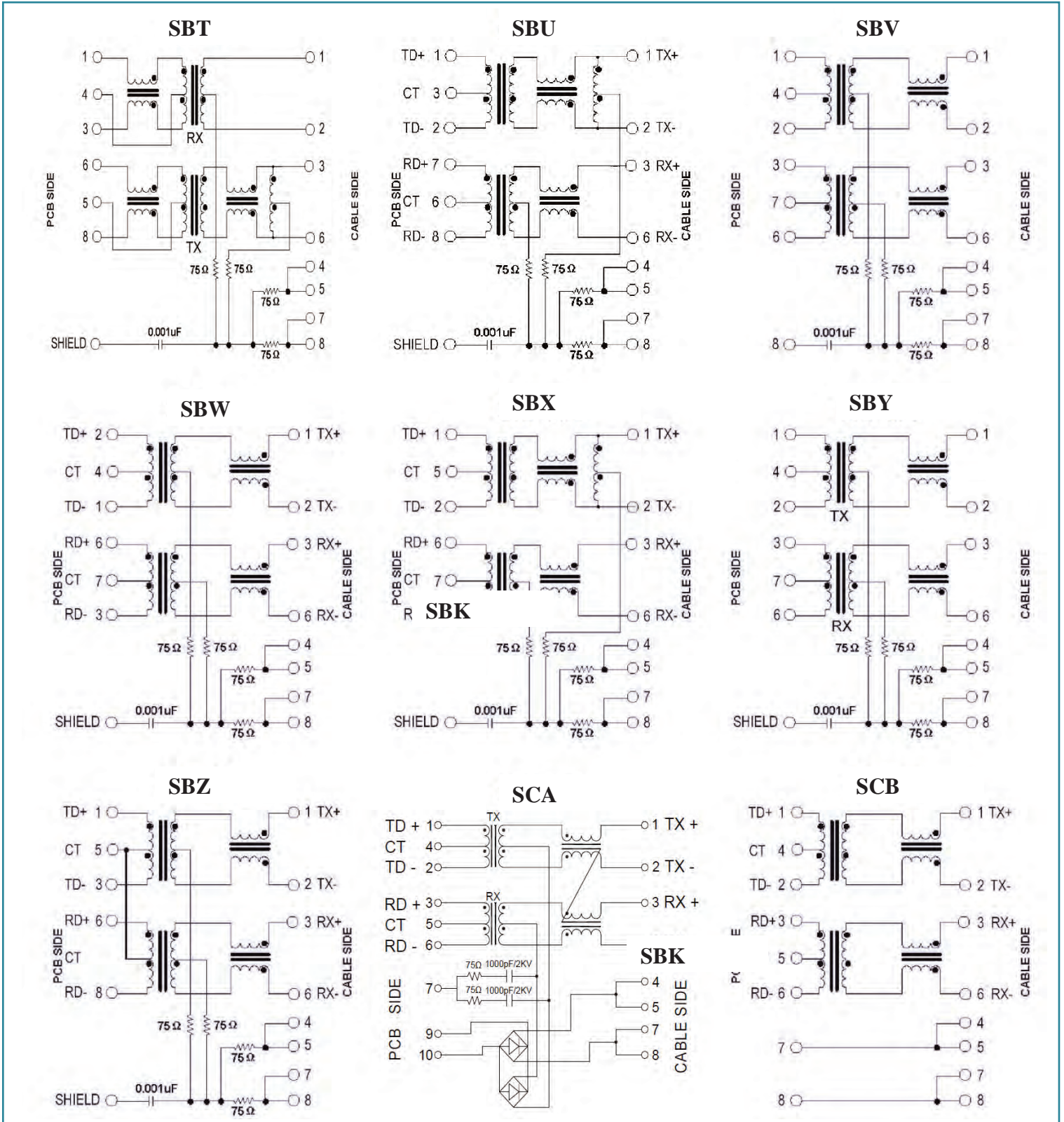

ABRACON IS
ISO 9001:2008
CERTIFIED

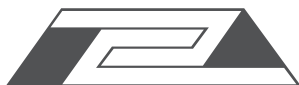

ABRACON
CORPORATION

Visit www.abracon.com for Terms & Conditions of Sale
30332 Esperanza, Rancho Santa Margarita, California 92688
tel 949-546-8000 | fax 949-546-8001 | www.abracon.com

Revised: 04.21.11

RJ45 10/100 Base-T Jack with Magnetic Module

ARJ11B

RoHS
Compliant



16.26 x 13.84 x 21.59mm

SCHEMATICS

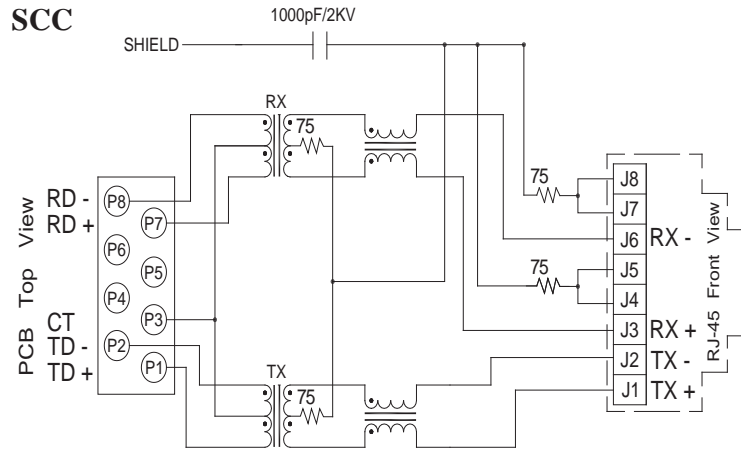

LED POLARITY

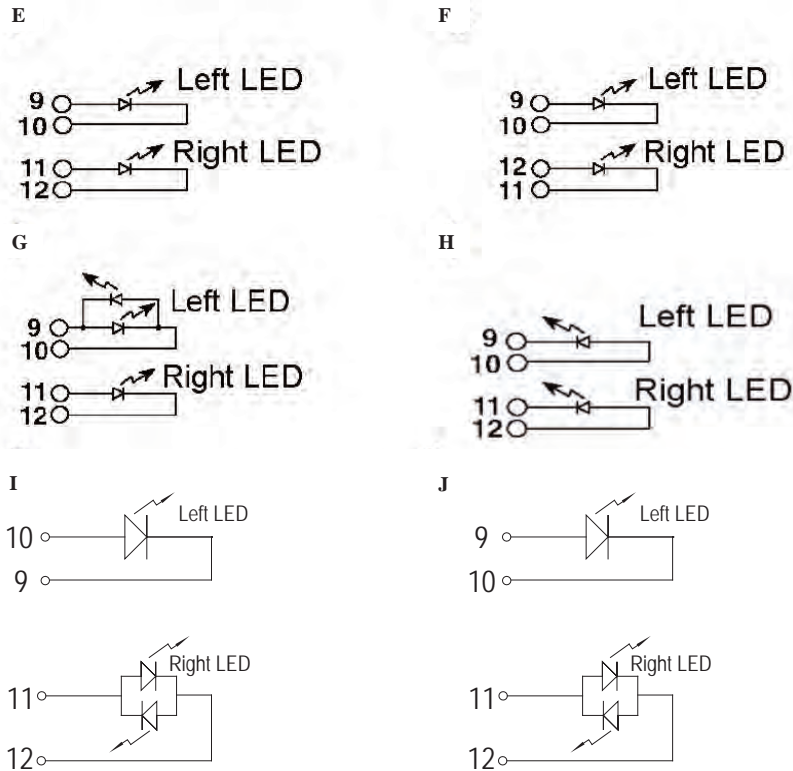

Vin=2.1Vdc TYP. 2.5Vdc MAX.

ABRACON IS
ISO 9001:2008
CERTIFIED



Visit www.abracon.com for Terms & Conditions of Sale
30332 Esperanza, Rancho Santa Margarita, California 92688
tel 949-546-8000 | fax 949-546-8001 | www.abracon.com

Revised: 04.21.11

RJ45 10/100 Base-T Jack with Magnetic Module

ARJ11B

RoHS
Compliant



16.26 x 13.84 x 21.59mm

REFLOW PROFILE

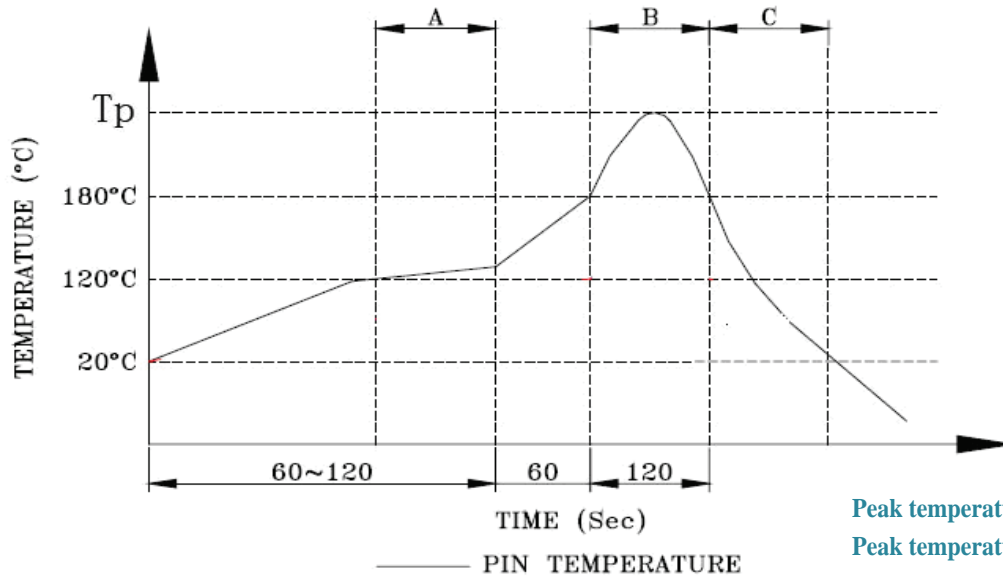

A. Preheating B. Soldering C. Gradual Cooling

TAPE & REEL:

Packing 60pcs/tray
Packaging material: PET

Outer carton unit 1320 pcs/ 22 Trays/box

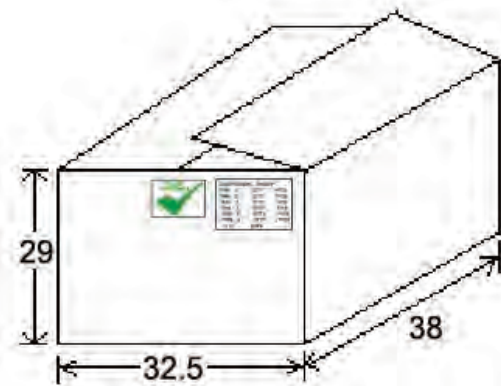
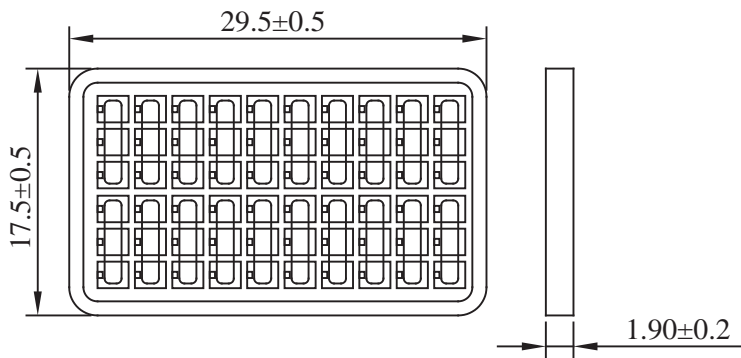

Dimensions: cm

ATTENTION: Abracon Corporation's products are COTS – Commercial-Off-The-Shelf products; suitable for Commercial, Industrial and, where designated, Automotive Applications. Abracon's products are not specifically designed for Military, Aviation, Aerospace, Life-dependant Medical applications or any application requiring high reliability where component failure could result in loss of life and/or property. For applications requiring high reliability and/or presenting an extreme operating environment, written consent and authorization from Abracon Corporation is required. Please contact Abracon Corporation for more information.

ABRACON IS
ISO 9001:2008
CERTIFIED

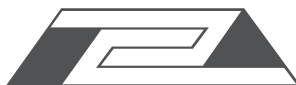

ABRACON
CORPORATION

Visit www.abracon.com for Terms & Conditions of Sale
30332 Esperanza, Rancho Santa Margarita, California 92688
tel 949-546-8000 | fax 949-546-8001 | www.abracon.com

Revised: 04.21.11