

# MJD31, MJD31C (NPN), MJD32, MJD32C (PNP)



**ON Semiconductor®**

<http://onsemi.com>

## Complementary Power Transistors

### DPAK For Surface Mount Applications

Designed for general purpose amplifier and low speed switching applications.

#### Features

- Lead Formed for Surface Mount Applications in Plastic Sleeves
- Straight Lead Version in Plastic Sleeves ("1" Suffix)
- Lead Formed Version in 16 mm Tape and Reel ("T4" Suffix)
- Electrically Similar to Popular TIP31 and TIP32 Series
- Epoxy Meets UL 94, V-0 @ 0.125 in
- ESD Ratings: Human Body Model, 3B > 8000 V  
Machine Model, C > 400 V
- These are Pb-Free Packages

#### MAXIMUM RATINGS

Rating	Symbol	Max	Unit
Collector-Emitter Voltage MJD31, MJD32 MJD31C, MJD32C	$V_{CEO}$	40 100	Vdc
Collector-Base Voltage MJD31, MJD32 MJD31C, MJD32C	$V_{CB}$	40 100	Vdc
Emitter-Base Voltage	$V_{EB}$	5	Vdc
Collector Current – Continuous – Peak	$I_C$	3 5	Adc
Base Current	$I_B$	1	Adc
Total Power Dissipation @ $T_C = 25^\circ\text{C}$ Derate above $25^\circ\text{C}$	$P_D$	15 0.12	W W/ $^\circ\text{C}$
Total Power Dissipation @ $T_A = 25^\circ\text{C}$ Derate above $25^\circ\text{C}$	$P_D$	1.56 0.012	W W/ $^\circ\text{C}$
Operating and Storage Junction Temperature Range	$T_J, T_{stg}$	-65 to +150	$^\circ\text{C}$

Stresses exceeding Maximum Ratings may damage the device. Maximum Ratings are stress ratings only. Functional operation above the Recommended Operating Conditions is not implied. Extended exposure to stresses above the Recommended Operating Conditions may affect device reliability.

#### THERMAL CHARACTERISTICS

Characteristic	Symbol	Max	Unit
Thermal Resistance, Junction-to-Case	$R_{\theta JC}$	8.3	$^\circ\text{C}/\text{W}$
Thermal Resistance, Junction-to-Ambient*	$R_{\theta JA}$	80	$^\circ\text{C}/\text{W}$
Lead Temperature for Soldering Purposes	$T_L$	260	$^\circ\text{C}$

\*These ratings are applicable when surface mounted on the minimum pad sizes recommended.

**SILICON  
POWER TRANSISTORS  
3 AMPERES  
40 AND 100 VOLTS  
15 WATTS**

#### MARKING DIAGRAMS

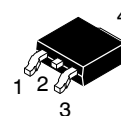

**DPAK  
CASE 369C  
STYLE 1**

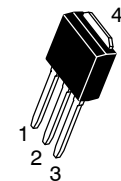
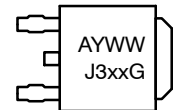

**DPAK-3  
CASE 369D  
STYLE 1**

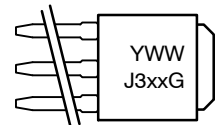

A = Site Code  
Y = Year  
WW = Work Week  
xx = 1, 1C, 2, or 2C  
G = Pb-Free Package

#### ORDERING INFORMATION

See detailed ordering and shipping information in the package dimensions section on page 8 of this data sheet.

# MJD31, MJD31C (NPN), MJD32, MJD32C (PNP)

## ELECTRICAL CHARACTERISTICS (T<sub>C</sub> = 25°C unless otherwise noted)

Characteristic	Symbol	Min	Max	Unit
----------------	--------	-----	-----	------

### OFF CHARACTERISTICS

Collector-Emitter Sustaining Voltage (Note 1) (I <sub>C</sub> = 30 mA <sub>dc</sub> , I <sub>B</sub> = 0)	MJD31, MJD32 MJD31C, MJD32C	V <sub>CEO(sus)</sub>	40 100	- -	V <sub>dc</sub>
Collector Cutoff Current (V <sub>CE</sub> = 40 V <sub>dc</sub> , I <sub>B</sub> = 0) (V <sub>CE</sub> = 60 V <sub>dc</sub> , I <sub>B</sub> = 0)	MJD31, MJD32 MJD31C, MJD32C	I <sub>CEO</sub>	-	50	μA <sub>dc</sub>
Collector Cutoff Current (V <sub>CE</sub> = Rated V <sub>CEO</sub> , V <sub>EB</sub> = 0)		I <sub>CES</sub>	-	20	μA <sub>dc</sub>
Emitter Cutoff Current (V <sub>BE</sub> = 5 V <sub>dc</sub> , I <sub>C</sub> = 0)		I <sub>EBO</sub>	-	1	mA <sub>dc</sub>

### ON CHARACTERISTICS (Note 1)

DC Current Gain (I <sub>C</sub> = 1 A <sub>dc</sub> , V <sub>CE</sub> = 4 V <sub>dc</sub> ) (I <sub>C</sub> = 3 A <sub>dc</sub> , V <sub>CE</sub> = 4 V <sub>dc</sub> )		h <sub>FE</sub>	25 10	- 50	-
Collector-Emitter Saturation Voltage (I <sub>C</sub> = 3 A <sub>dc</sub> , I <sub>B</sub> = 375 mA <sub>dc</sub> )		V <sub>CE(sat)</sub>	-	1.2	V <sub>dc</sub>
Base-Emitter On Voltage (I <sub>C</sub> = 3 A <sub>dc</sub> , V <sub>CE</sub> = 4 V <sub>dc</sub> )		V <sub>BE(on)</sub>	-	1.8	V <sub>dc</sub>

### DYNAMIC CHARACTERISTICS

Current Gain – Bandwidth Product (Note 2) (I <sub>C</sub> = 500 mA <sub>dc</sub> , V <sub>CE</sub> = 10 V <sub>dc</sub> , f <sub>test</sub> = 1 MHz)		f <sub>T</sub>	3	-	MHz
Small-Signal Current Gain (I <sub>C</sub> = 0.5 A <sub>dc</sub> , V <sub>CE</sub> = 10 V <sub>dc</sub> , f = 1 kHz)		h <sub>fe</sub>	20	-	-

1. Pulse Test: Pulse Width ≤ 300 μs, Duty Cycle ≤ 2%.
2. f<sub>T</sub> = |h<sub>fe</sub>| • f<sub>test</sub>.

# MJD31, MJD31C (NPN), MJD32, MJD32C (PNP)

## TYPICAL CHARACTERISTICS

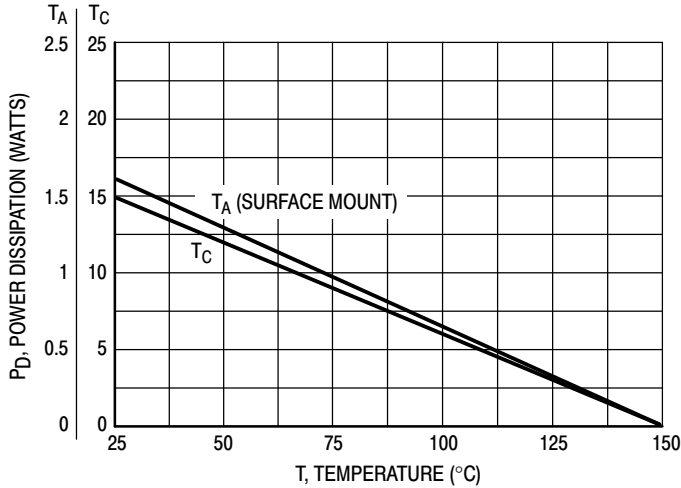
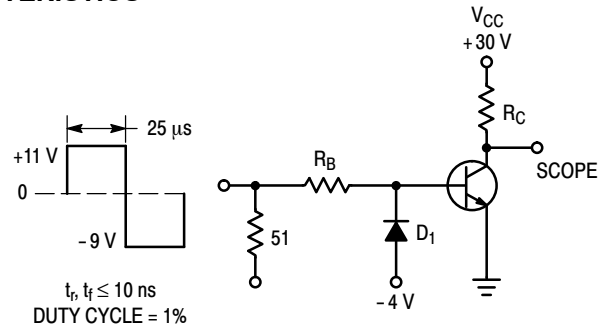

Figure 1. Power Derating



$R_B$  and  $R_C$  VARIED TO OBTAIN DESIRED CURRENT LEVELS  
 $D_1$  MUST BE FAST RECOVERY TYPE, e.g.:  
 1N5825 USED ABOVE  $I_B \approx 100$  mA  
 MSD6100 USED BELOW  $I_B \approx 100$  mA  
 REVERSE ALL POLARITIES FOR PNP.

Figure 2. Switching Time Test Circuit

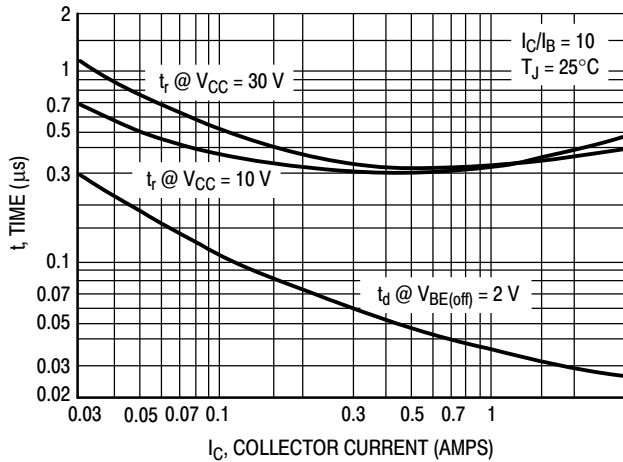

Figure 3. Turn-On Time

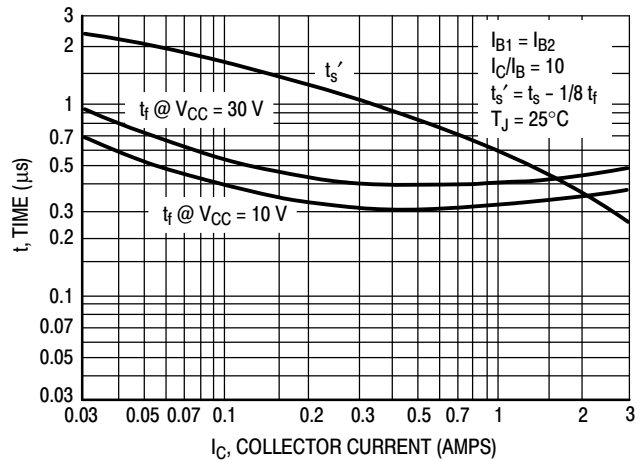

Figure 4. Turn-Off Time

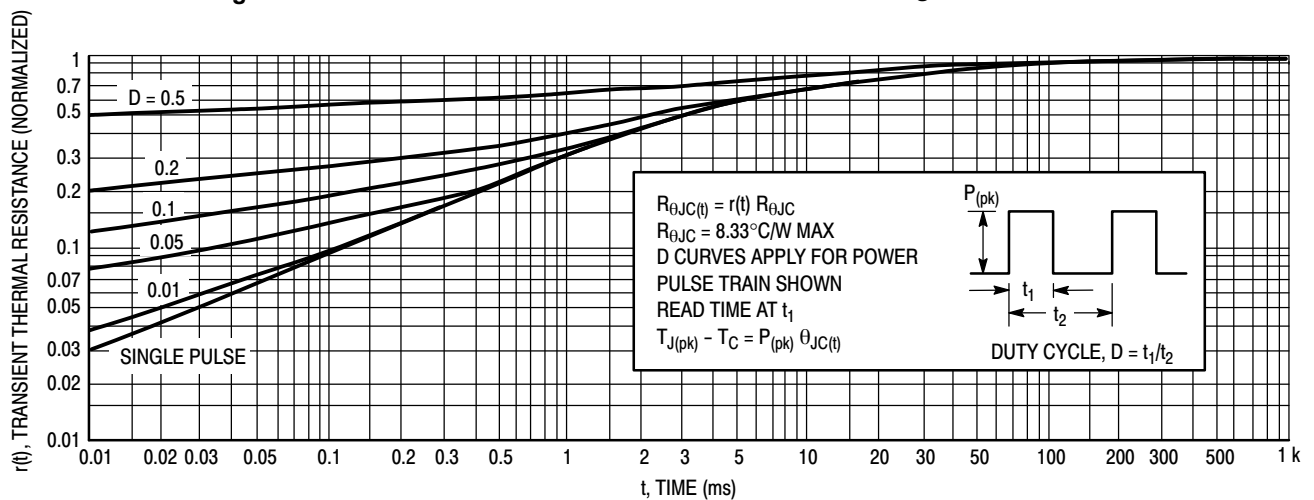

Figure 5. Thermal Response

# MJD31, MJD31C (NPN), MJD32, MJD32C (PNP)

## TYPICAL CHARACTERISTICS – MJD31, MJD31C (NPN)

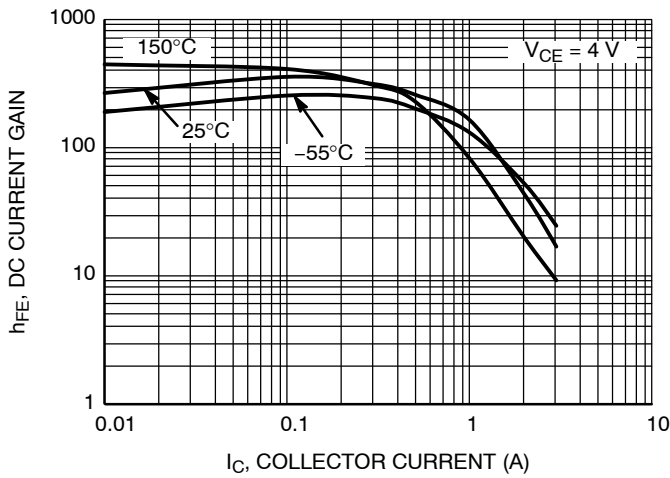

Figure 6. DC Current Gain at  $V_{CE} = 4\text{ V}$

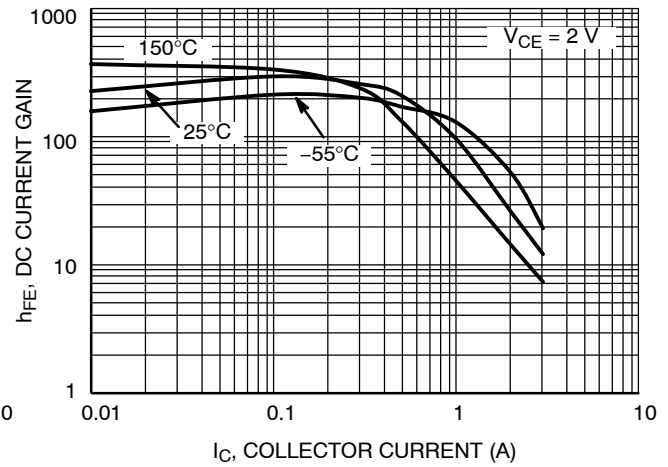

Figure 7. DC Current Gain at  $V_{CE} = 2\text{ V}$

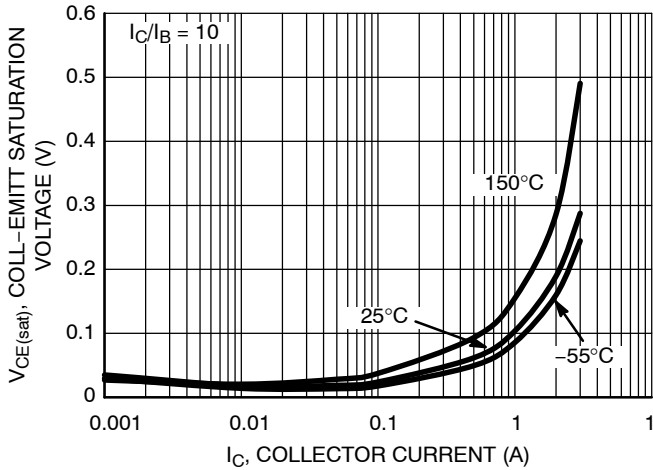

Figure 8. Collector-Emitt Saturation Voltage

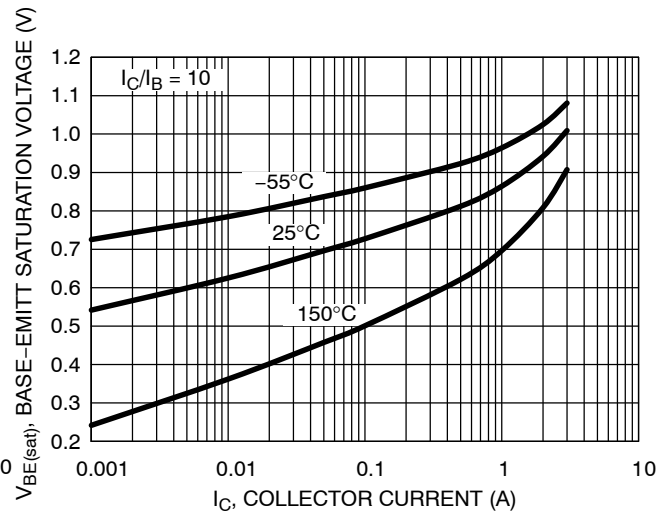

Figure 9. Base-Emitt Saturation Voltage

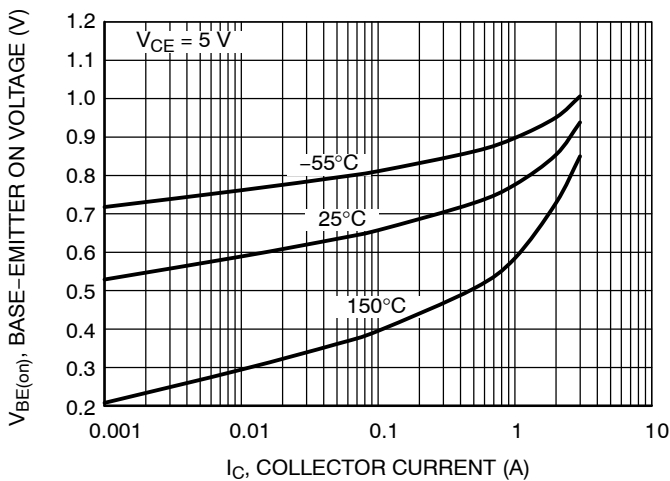

Figure 10. Base-Emitt "On" Voltage

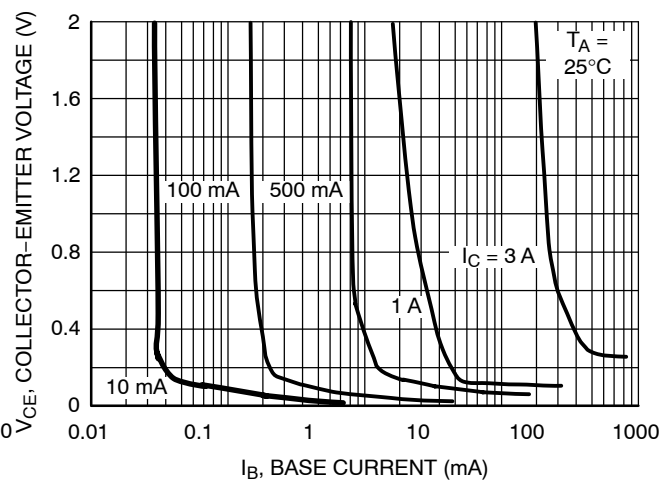

Figure 11. Collector Saturation Region

# MJD31, MJD31C (NPN), MJD32, MJD32C (PNP)

## TYPICAL CHARACTERISTICS – MJD31, MJD31C (NPN)

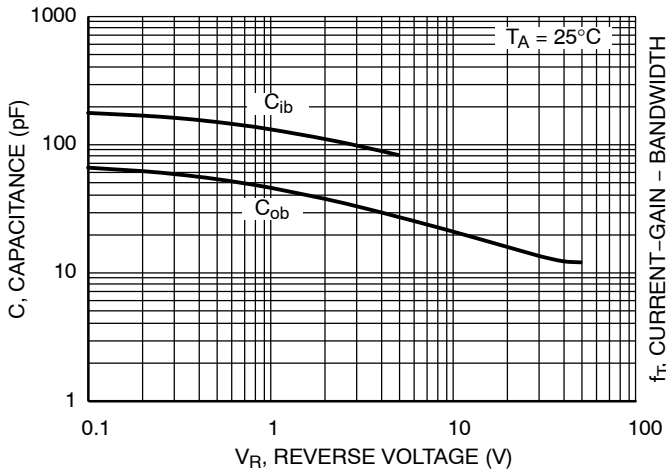

Figure 12. Capacitance

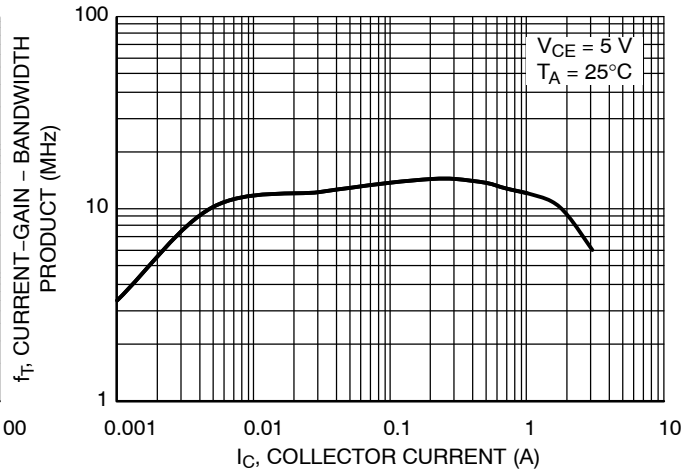

Figure 13. Current-Gain-Bandwidth Product

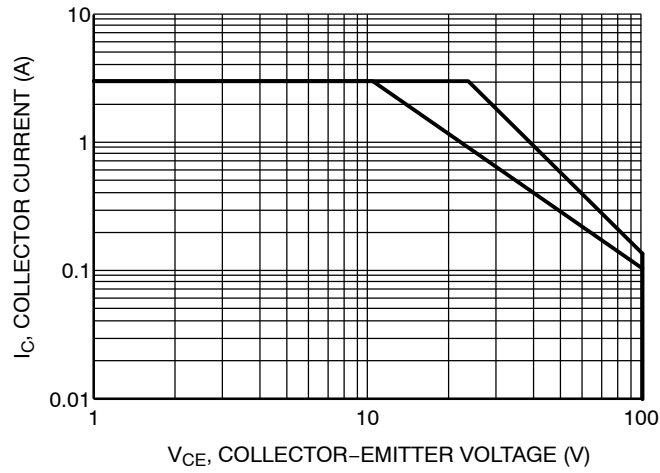

Figure 14. Safe Operating Area

# MJD31, MJD31C (NPN), MJD32, MJD32C (PNP)

## TYPICAL CHARACTERISTICS – MJD32, MJD32C (PNP)

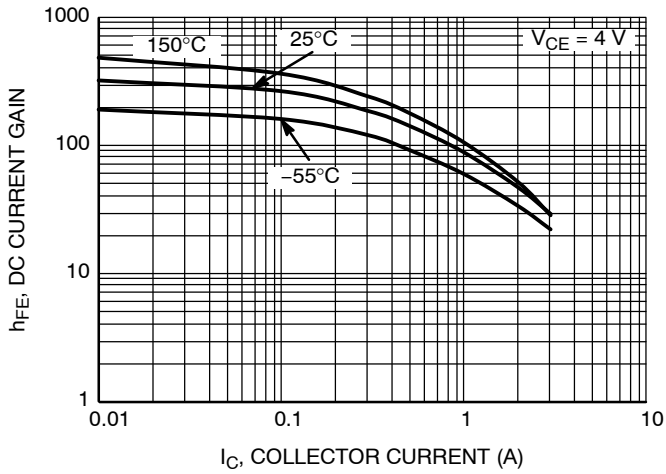

Figure 15. DC Current Gain at  $V_{CE} = 4\text{ V}$

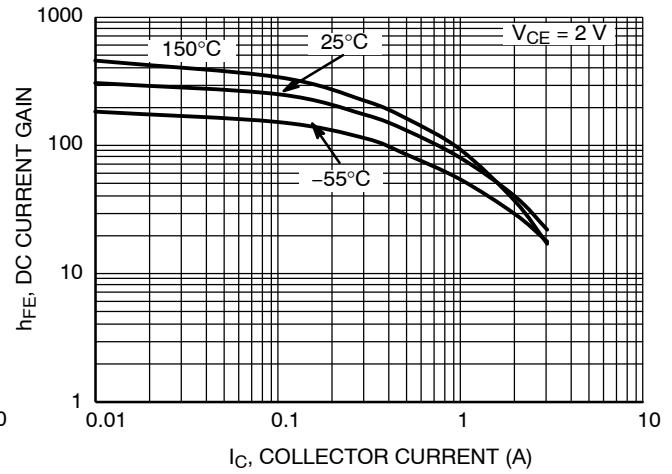

Figure 16. DC Current Gain at  $V_{CE} = 2\text{ V}$

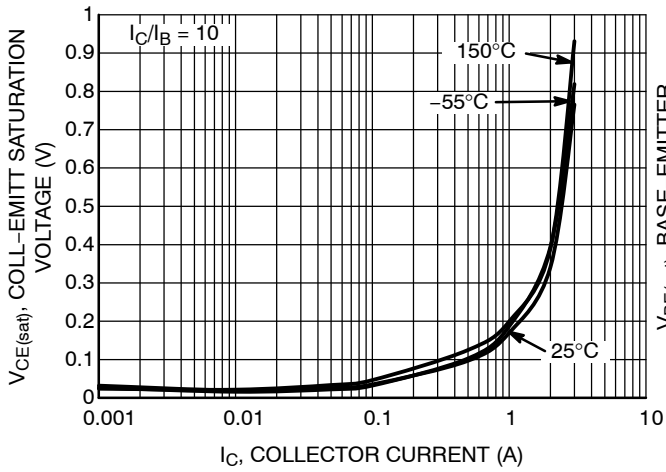

Figure 17. Collector-Emitter Saturation Voltage

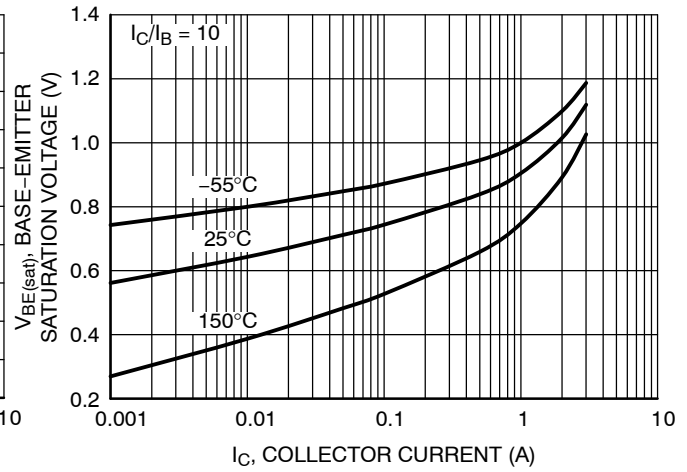

Figure 18. Base-Emitter Saturation Voltage

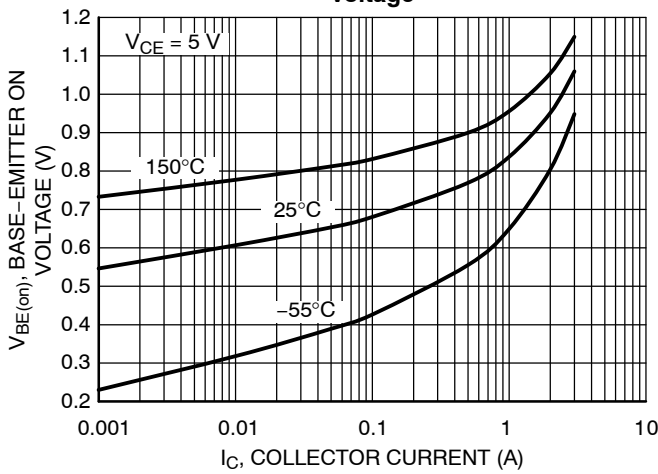

Figure 19. Base-Emitter "On" Voltage

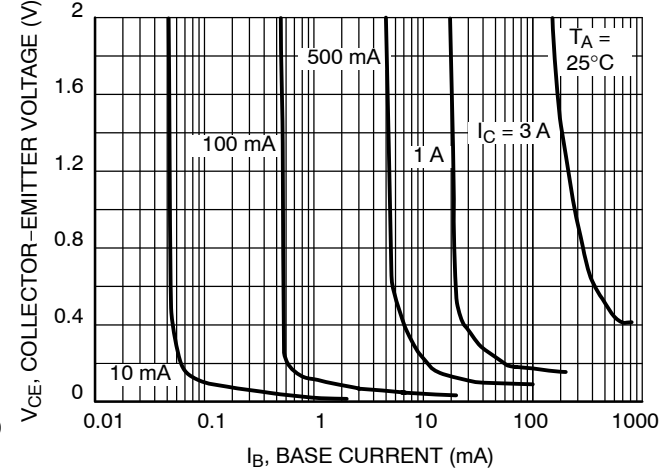

Figure 20. Collector Saturation Region

# MJD31, MJD31C (NPN), MJD32, MJD32C (PNP)

## TYPICAL CHARACTERISTICS

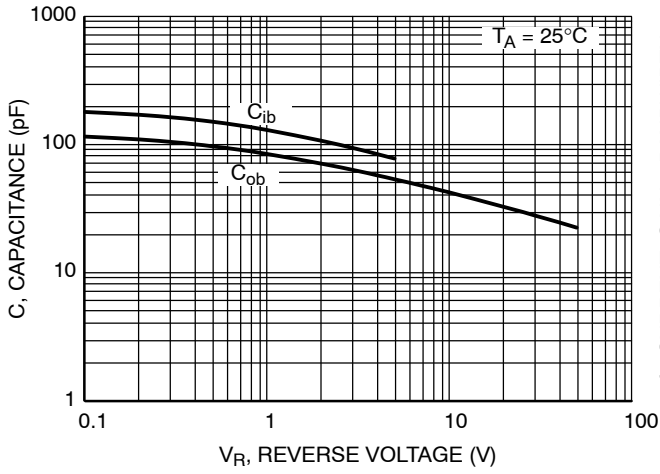

Figure 21. Capacitance

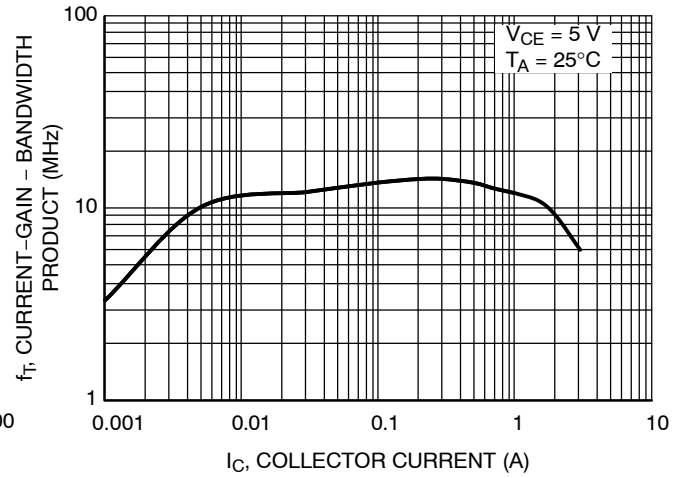

Figure 22. Current-Gain-Bandwidth Product

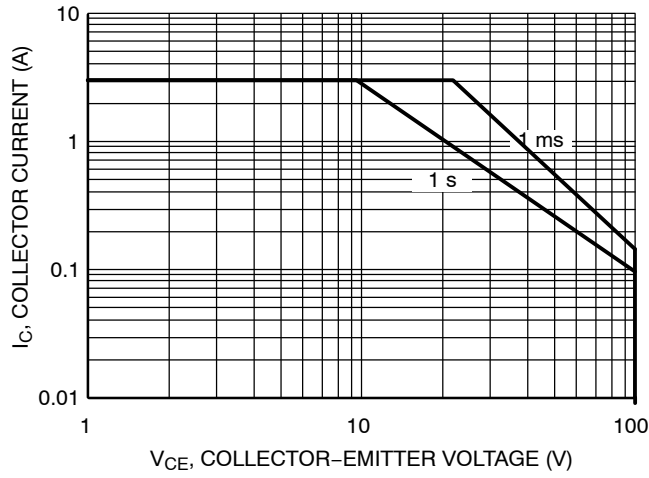

Figure 23. Safe Operating Area

## MJD31, MJD31C (NPN), MJD32, MJD32C (PNP)

### ORDERING INFORMATION

Device	Package Type	Package	Shipping†
MJD31CG	DPAK (Pb-Free)	369C	75 Units / Rail
MJD31C1G	DPAK-3 (Pb-Free)	369D	75 Units / Rail
MJD31CRLG	DPAK (Pb-Free)	369C	1800 Tape & Reel
MJD31CT4G	DPAK (Pb-Free)	369C	2500 Tape & Reel
MJD31T4G	DPAK (Pb-Free)	369C	2500 Tape & Reel
MJD32CG	DPAK (Pb-Free)	369C	75 Units / Rail
MJD32CRLG	DPAK (Pb-Free)	369C	1800 Tape & Reel
MJD32CT4	DPAK	369C	2500 Tape & Reel
MJD32CT4G	DPAK (Pb-Free)	369C	2500 Tape & Reel
MJD32RLG	DPAK (Pb-Free)	369C	1800 Tape & Reel
MJD32T4G	DPAK (Pb-Free)	369C	2500 Tape & Reel

†For information on tape and reel specifications, including part orientation and tape sizes, please refer to our Tape and Reel Packaging Specifications Brochure, BRD8011/D.



# MJD31, MJD31C (NPN), MJD32, MJD32C (PNP)

## PACKAGE DIMENSIONS

### DPAK CASE 369C-01 ISSUE D

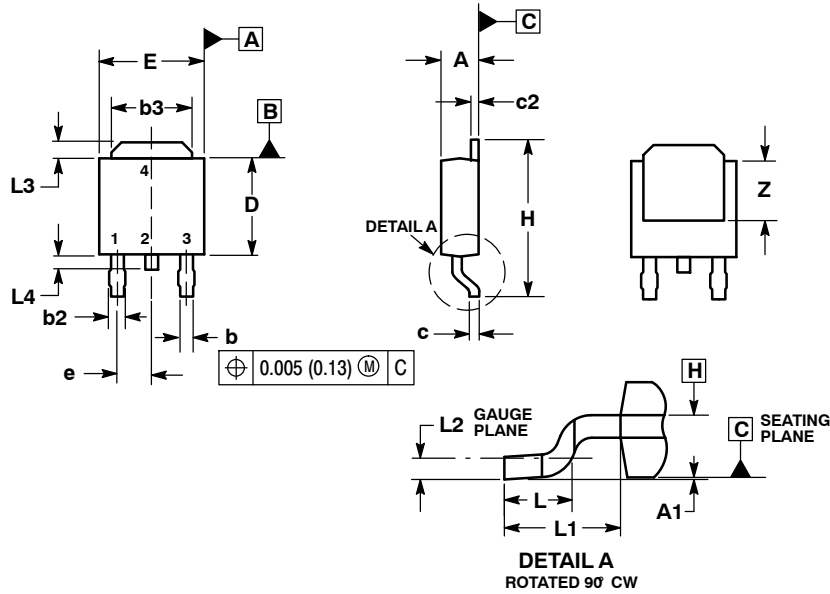

**NOTES:**

1. DIMENSIONING AND TOLERANCING PER ASME Y14.5M, 1994.
2. CONTROLLING DIMENSION: INCHES.
3. THERMAL PAD CONTOUR OPTIONAL WITHIN DIMENSIONS b3, L3 and Z.
4. DIMENSIONS D AND E DO NOT INCLUDE MOLD FLASH, PROTRUSIONS, OR BURRS. MOLD FLASH, PROTRUSIONS, OR GATE BURRS SHALL NOT EXCEED 0.006 INCHES PER SIDE.
5. DIMENSIONS D AND E ARE DETERMINED AT THE OUTERMOST EXTREMES OF THE PLASTIC BODY.
6. DATUMS A AND B ARE DETERMINED AT DATUM PLANE H.

DIM	INCHES		MILLIMETERS	
	MIN	MAX	MIN	MAX
A	0.086	0.094	2.18	2.38
A1	0.000	0.005	0.00	0.13
b	0.025	0.035	0.63	0.89
b2	0.030	0.045	0.76	1.14
b3	0.180	0.215	4.57	5.46
c	0.018	0.024	0.46	0.61
c2	0.018	0.024	0.46	0.61
D	0.235	0.245	5.97	6.22
E	0.250	0.265	6.35	6.73
e	0.090 BSC		2.29 BSC	
H	0.370	0.410	9.40	10.41
L	0.055	0.070	1.40	1.78
L1	0.108 REF		2.74 REF	
L2	0.020 BSC		0.51 BSC	
L3	0.035	0.050	0.89	1.27
L4	---	0.040	---	1.01
Z	0.155	---	3.93	---

### SOLDERING FOOTPRINT\*

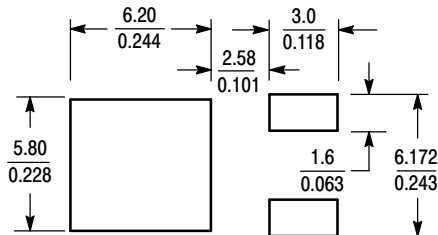

SCALE 3:1 ( $\frac{\text{mm}}{\text{inches}}$ )

**STYLE 1:**

- PIN 1. BASE
- COLLECTOR
- EMITTER
- COLLECTOR

\*For additional information on our Pb-Free strategy and soldering details, please download the ON Semiconductor Soldering and Mounting Techniques Reference Manual, SOLDERRM/D.

# MJD31, MJD31C (NPN), MJD32, MJD32C (PNP)

## PACKAGE DIMENSIONS

### IPAK CASE 369D-01 ISSUE C

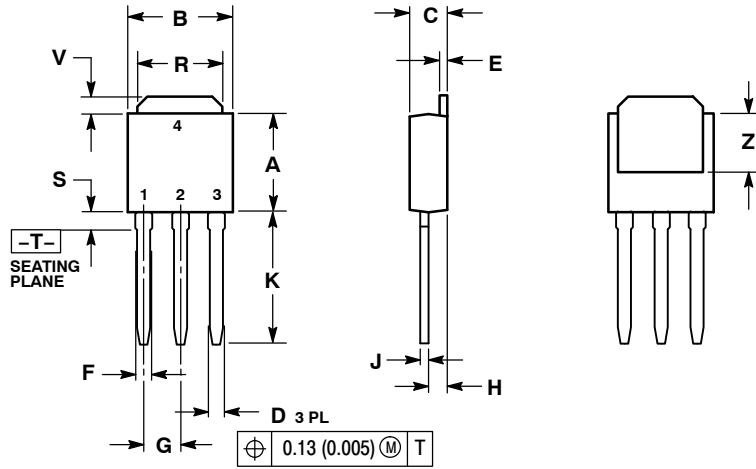

#### NOTES:

1. DIMENSIONING AND TOLERANCING PER ANSI Y14.5M, 1982.
2. CONTROLLING DIMENSION: INCH.

DIM	INCHES		MILLIMETERS	
	MIN	MAX	MIN	MAX
A	0.235	0.245	5.97	6.35
B	0.250	0.265	6.35	6.73
C	0.086	0.094	2.19	2.38
D	0.027	0.035	0.69	0.88
E	0.018	0.023	0.46	0.58
F	0.037	0.045	0.94	1.14
G	0.090 BSC		2.29 BSC	
H	0.034	0.040	0.87	1.01
J	0.018	0.023	0.46	0.58
K	0.350	0.380	8.89	9.65
R	0.180	0.215	4.45	5.45
S	0.025	0.040	0.63	1.01
V	0.035	0.050	0.89	1.27
Z	0.155	---	3.93	---

#### STYLE 1:

- PIN 1: BASE  
 2. COLLECTOR  
 3. EMITTER  
 4. COLLECTOR

ON Semiconductor and are registered trademarks of Semiconductor Components Industries, LLC (SCILLC). SCILLC reserves the right to make changes without further notice to any products herein. SCILLC makes no warranty, representation or guarantee regarding the suitability of its products for any particular purpose, nor does SCILLC assume any liability arising out of the application or use of any product or circuit, and specifically disclaims any and all liability, including without limitation special, consequential or incidental damages. "Typical" parameters which may be provided in SCILLC data sheets and/or specifications can and do vary in different applications and actual performance may vary over time. All operating parameters, including "Typicals" must be validated for each customer application by customer's technical experts. SCILLC does not convey any license under its patent rights nor the rights of others. SCILLC products are not designed, intended, or authorized for use as components in systems intended for surgical implant into the body, or other applications intended to support or sustain life, or for any other application in which the failure of the SCILLC product could create a situation where personal injury or death may occur. Should Buyer purchase or use SCILLC products for any such unintended or unauthorized application, Buyer shall indemnify and hold SCILLC and its officers, employees, subsidiaries, affiliates, and distributors harmless against all claims, costs, damages, and expenses, and reasonable attorney fees arising out of, directly or indirectly, any claim of personal injury or death associated with such unintended or unauthorized use, even if such claim alleges that SCILLC was negligent regarding the design or manufacture of the part. SCILLC is an Equal Opportunity/Affirmative Action Employer. This literature is subject to all applicable copyright laws and is not for resale in any manner.

### PUBLICATION ORDERING INFORMATION

#### LITERATURE FULFILLMENT:

Literature Distribution Center for ON Semiconductor  
 P.O. Box 5163, Denver, Colorado 80217 USA  
**Phone:** 303-675-2175 or 800-344-3860 Toll Free USA/Canada  
**Fax:** 303-675-2176 or 800-344-3867 Toll Free USA/Canada  
**Email:** [orderlit@onsemi.com](mailto:orderlit@onsemi.com)

**N. American Technical Support:** 800-282-9855 Toll Free  
 USA/Canada  
**Europe, Middle East and Africa Technical Support:**  
 Phone: 421 33 790 2910  
**Japan Customer Focus Center**  
 Phone: 81-3-5773-3850

**ON Semiconductor Website:** [www.onsemi.com](http://www.onsemi.com)

**Order Literature:** <http://www.onsemi.com/orderlit>

For additional information, please contact your local Sales Representative