

**FAST RECOVERY DIODE  
INSULATED MODULE**

# AFF450AHVI

\*Full ermetic packaging  
\*Industrial compatible packaging  
\*Insulation using Aln substrate  
\*6KVrms insulation voltage  
\*Contact screws available on request

Repetitive voltage up to **4500 V**  
Mean on-state current **450 A**  
Surge current **10 kA**

**FINAL SPECIFICATION**

apr 17 - ISSUE : 1

Symbol	Characteristic	Conditions	T <sub>j</sub> [°C]	Value	Unit
<b>BLOCKING</b>					
V <sub>RRM</sub>	Repetitive peak reverse voltage		150	4500	V
V <sub>RSM</sub>	Non-repetitive peak reverse voltage		150	4600	V
I <sub>RRM</sub>	Repetitive peak reverse current		150	50	mA
<b>CONDUCTING</b>					
I <sub>F(AV)</sub>	Mean on-state current	180° sin, 50Hz, T <sub>c</sub> =80°C		450	A
I <sub>F(AV)</sub>	Mean on-state current	180° sin. 50Hz, T <sub>c</sub> =55°C		560	A
I <sub>FSM</sub>	Surge on-state current	sine wave, 10 ms	150	10	kA
I <sup>2</sup> t	I <sup>2</sup> t	without reverse voltage		500 x1E3	A <sup>2</sup> s
V <sub>F</sub>	On-state voltage	On-state curren 1500 A	150	2,525	V
V <sub>F(TO)</sub>	Threshold voltage		150	1,40	V
r <sub>F</sub>	On-state slope resistance		150	0,75	mohm
<b>SWITCHING</b>					
t <sub>rr</sub>	Reverse recovery time	I <sub>F</sub> = 1000 A di/dt= 150 A/μs V <sub>R</sub> = 100 V	150	6,4	μs
Q <sub>rr</sub>	Reverse recovery charge			1600	μC
I <sub>rr</sub>	Peak reverse recovery current			500	A
s	Softness (s-factor), min				
E <sub>OFF</sub>	Turn off energy dissipation				J
V <sub>FR</sub>	Peak forward recovery (Typical Value)	di/dt= 400 A/μs	150	90	V
<b>MOUNTING</b>					
R <sub>th(j-c)</sub>	Thermal impedance	Junction to case, per element		70	°C/kW
R <sub>th(c-h)</sub>	Thermal impedance	Case to heatsink, per element		20	°C/kW
T <sub>j</sub>	Operating junction temperature			-30 / 150	°C
V <sub>ins</sub>	RMS insulation voltage	50Hz, circuit to base,all terminal shorted, t=1min	25	6000	V
T	Mounting tourque	Case to heatsink		4 to 6	Nm
		Busbars to terminals		12 to 18	Nm
	Mass			1500	g

**ORDERING INFORMATION : AFF450AHVI S 45**

standard specification —┘┘ VRRM/100

**SWITCHING CHARACTERISTICS**

FORWARD RECOVERY VOLTAGE

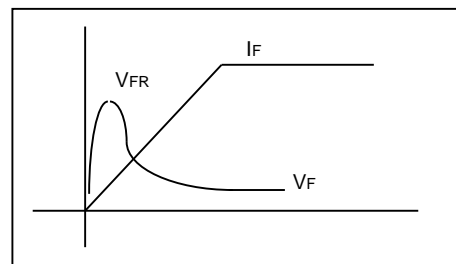
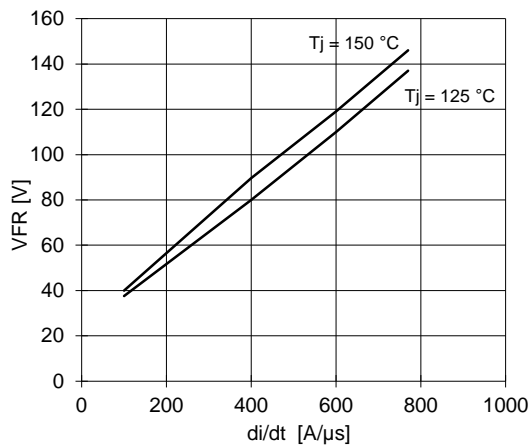

REVERSE RECOVERY CHARGE

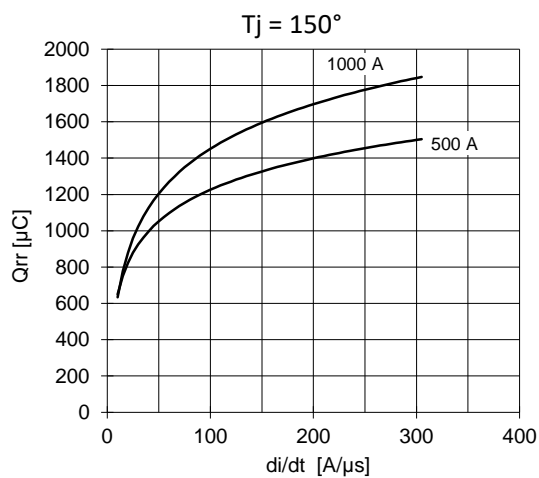

REVERSE RECOVERY CURRENT

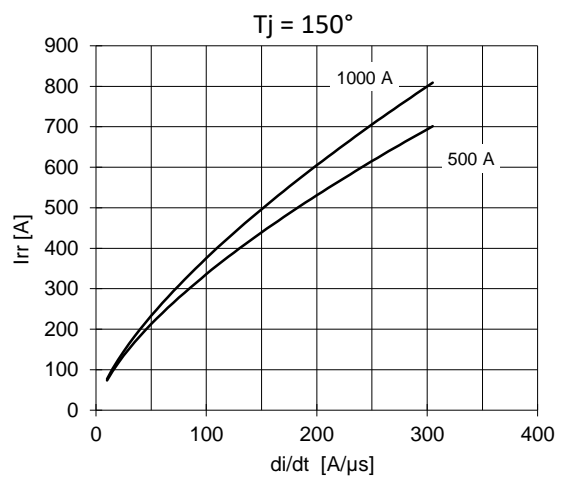

$t_a = I_{rr} / (di/dt) \quad t_b = t_{rr} - t_a$

Softness (s factor)  $s = t_b / t_a$

Energy dissipation during recovery  $E_r = V_r \cdot (Q_{rr} - I_{rr} \cdot t_a / 2)$

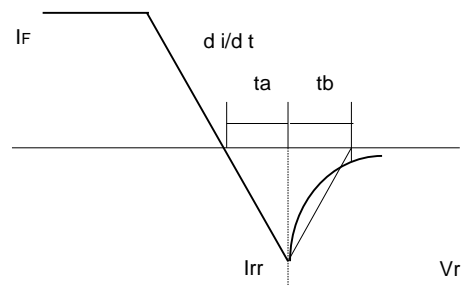

# AFF450AHVI



FINAL SPECIFICATION apr 17 - ISSUE : 1

ON-STATE CHARACTERISTIC  
T<sub>j</sub> = 150 °C

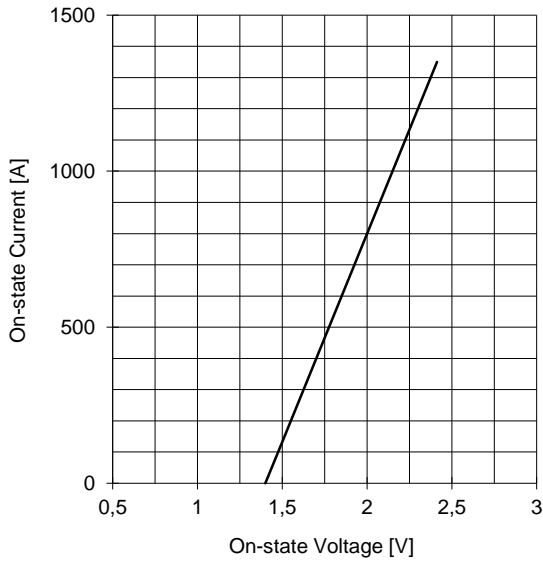

SURGE CHARACTERISTIC  
T<sub>j</sub> = 150 °C

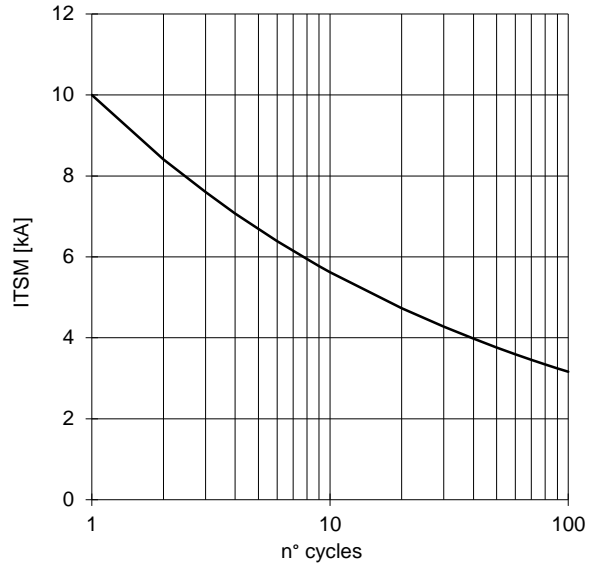

TRANSIENT THERMAL IMPEDANCE

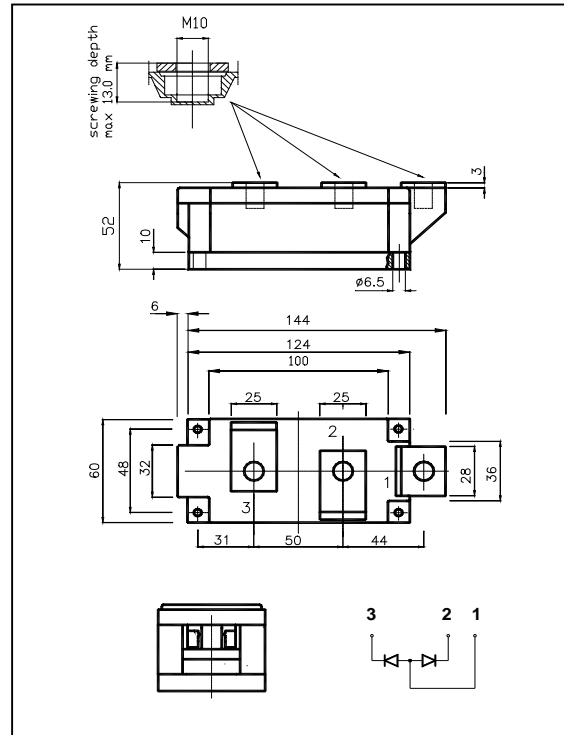
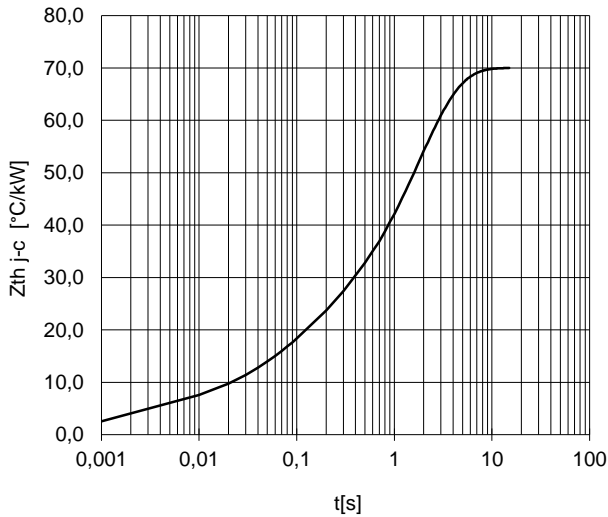

All the characteristics given in this data sheet are guaranteed only with uniform clamping force, cleaned and lubricated heatsink, surfaces with flatness < .03 mm and roughness < 2 μm. In the interest of product improvement POSEICO SPA reserves the right to change any data given in this data sheet at any time without previous notice. If not stated otherwise the maximum value of ratings (symbols over shaded background) and characteristics is reported.

Distributed by

