



LIGITEK

LIGITEK ELECTRONICS CO.,LTD.
Property of Ligitek Only

SUPER BRIGHT ROUND TYPE LED LAMPS

LVY3330

DATA SHEET

DOC. NO : QW0905-LVY3330

REV. : A

DATE : 19 - May - 2005



Package Dimensions

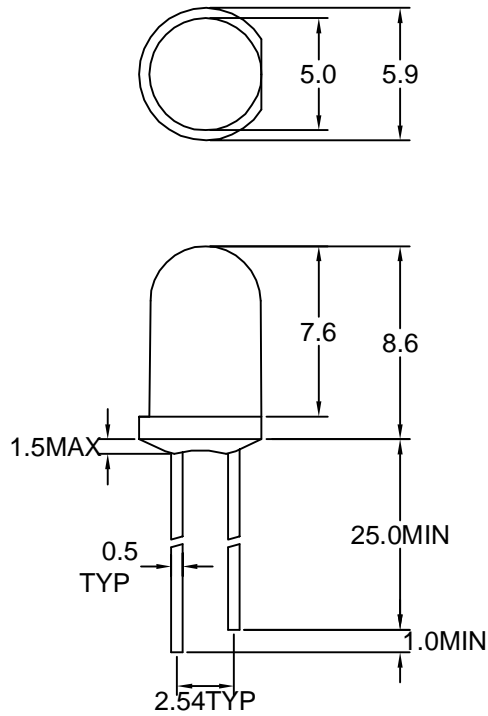

Note : 1.All dimension are in millimeter tolerance is $\pm 0.25\text{mm}$ unless otherwise noted.
2.Specifications are subject to change without notice.

Directivity Radiation

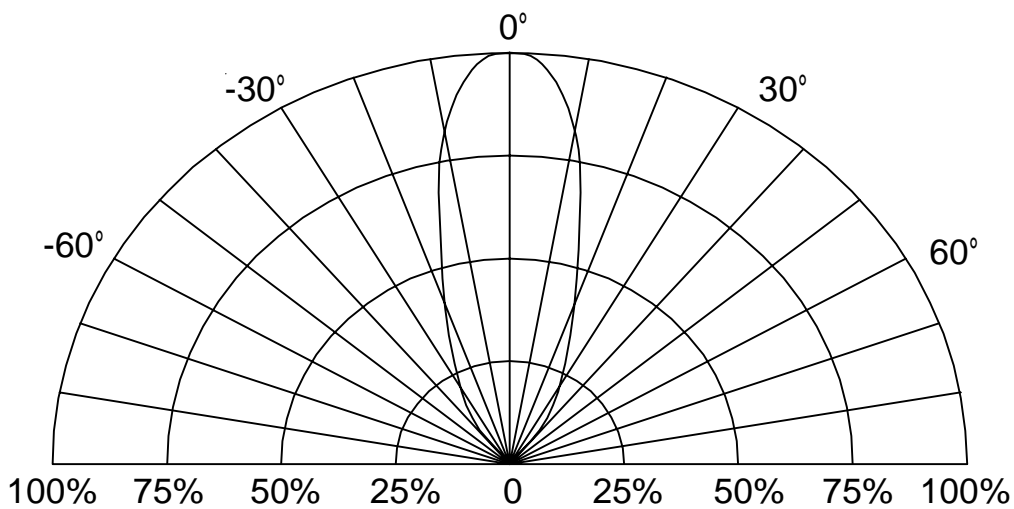



Absolute Maximum Ratings at Ta=25

Parameter	Symbol	Ratings	UNIT
		VY	
Forward Current	IF	30	mA
Peak Forward Current Duty 1/10@10KHz	IFP	60	mA
Power Dissipation	PD	75	mW
Reverse Current @5V	Ir	10	μ A
Electrostatic Discharge	ESD	2000	V
Operating Temperature	Topr	-40 ~ +85	
Storage Temperature	Tstg	-40 ~ +100	
Soldering Temperature	Tsol	Max 260 for 5 sec Max (2mm from body)	

Typical Electrical & Optical Characteristics (Ta=25)

PART NO	MATERIAL	COLOR		Dominant wave length Dnm	Spectral halfwidth nm	Forward voltage @20mA(V)		Luminous intensity @20mA(mcd)		Viewing angle 2 1/2 (deg)
		Emitted	Lens			Min.	Max.	Min.	Typ.	
LVY3330	AlGaInP	Yellow	Yellow Diffused	590	20	1.7	2.6	220	350	36

Note : 1.The forward voltage data did not including ±0.1V testing tolerance.
2. The luminous intensity data did not including ±15% testing tolerance.

Typical Electro-Optical Characteristics Curve

VY CHIP

Fig.1 Forward current vs. Forward Voltage

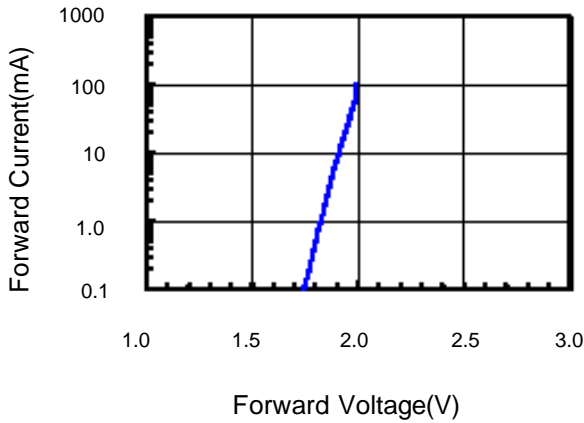

Fig.2 Relative Intensity vs. Forward Current

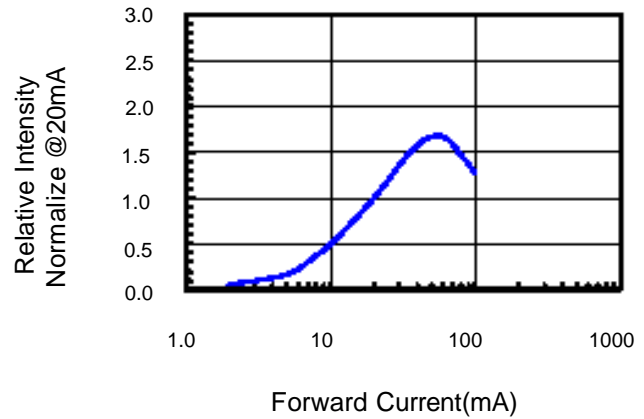

Fig.3 Forward Voltage vs. Temperature

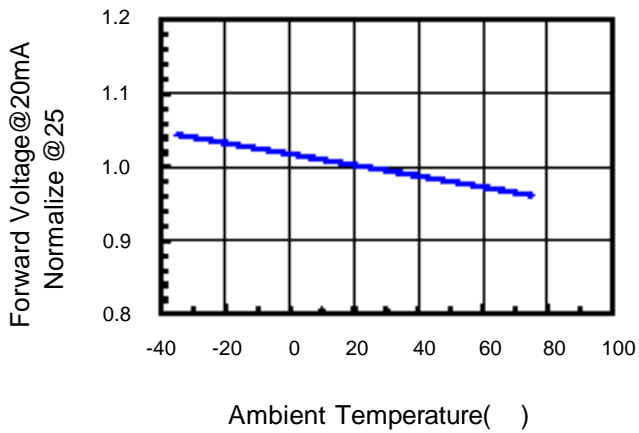

Fig.4 Relative Intensity vs. Temperature

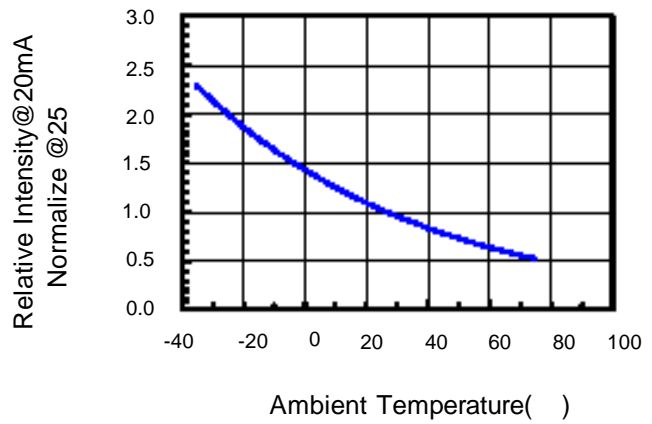
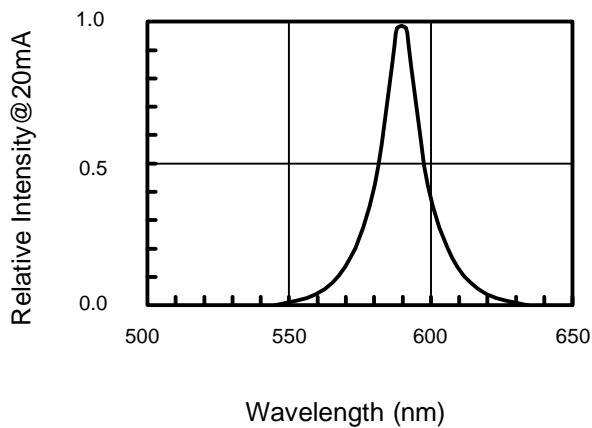

Fig.5 Relative Intensity vs. Wavelength



**Reliability Test:**

Test Item	Test Condition	Description	Reference Standard
Operating Life Test	1.Under Room Temperature 2.If=20mA 3.t=1000 hrs (-24hrs, +72hrs)	This test is conducted for the purpose of determining the resistance of a part in electrical and thermal stressed.	MIL-STD-750: 1026 MIL-STD-883: 1005 JIS C 7021: B-1
High Temperature Storage Test	1.Ta=105 ±5 2.t=1000 hrs (-24hrs, +72hrs)	The purpose of this is the resistance of the device which is laid under condition of high temperature for hours.	MIL-STD-883:1008 JIS C 7021: B-10
Low Temperature Storage Test	1.Ta=-40 ±5 2.t=1000 hrs (-24hrs, +72hrs)	The purpose of this is the resistance of the device which is laid under condition of low temperature for hours.	JIS C 7021: B-12
High Temperature High Humidity Test	1.Ta=65 ±5 2.RH=90%~95% 3.t=240hrs ±2hrs	The purpose of this test is the resistance of the device under tropical for hours.	MIL-STD-202:103B JIS C 7021: B-11
Thermal Shock Test	1.Ta=105 ±5 & -40 ±5 (10min) (10min) 2.total 10 cycles	The purpose of this is the resistance of the device to sudden extreme changes in high and low temperature.	MIL-STD-202: 107D MIL-STD-750: 1051 MIL-STD-883: 1011
Solder Resistance Test	1.T.Sol=260 ±5 2.Dwell time= 10 ±1sec.	This test intended to determine the thermal characteristic resistance of the device to sudden exposures at extreme changes in temperature when soldering the lead wire.	MIL-STD-202: 210A MIL-STD-750: 2031 JIS C 7021: A-1
Solderability Test	1.T.Sol=230 ±5 2.Dwell time=5 ±1sec	This test intended to see soldering well performed or not.	MIL-STD-202: 208D MIL-STD-750: 2026 MIL-STD-883: 2003 JIS C 7021: A-2