

Power SMD LED in PLCC-3 Package

Description

The TLM.32.. series is an advanced development in terms of heat dissipation.

The leadframe profile of this PLCC-3 SMD package is optimized to reduce the thermal resistance.

This allows higher drive current and doubles the light output compared to Vishay's high intensity SMD LED in PLCC-2 package.

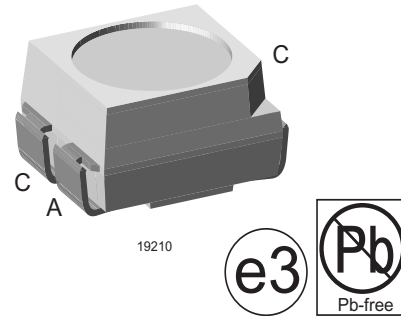

Features

- Utilizing AllnGaP technology
- Angle of half intensity $\pm \varphi = 60^\circ$
- Available in 8 mm tape
- Luminous intensity, color and forward voltage categorized per packing unit
- Luminous intensity ratio per packing unit $I_{Vmax}/I_{Vmin} \leq 1.6$
- ESD class 2
- Suitable for all soldering methods according to CECC
- Lead-free device

Applications

Traffic Signals and Signs
 Interior and exterior lighting
 Dashboard illumination
 Indicator and backlighting purposes for audio, video, LCD's switches, symbols, illuminated advertising etc.

Parts Table

Part	Color, Luminous Intensity
TLMPG3200	Pure Green, $I_V = 50$ mcd (typ.)
TLMYG3200	Yellow Green, $I_V = 130$ mcd (typ.)

Absolute Maximum Ratings

$T_{amb} = 25^\circ\text{C}$, unless otherwise specified

TLMPG3200, TLMYG3200

Parameter	Test condition	Symbol	Value	Unit
Reverse voltage		V_R	5	V
Forward current		I_F	70	mA
Power dissipation	$T_{amb} \leq 65^\circ\text{C}$ (290 K/W), $T_{amb} \leq 70^\circ\text{C}$ (270 K/W)	P_{tot}	180	mW
Junction temperature		T_j	125	$^\circ\text{C}$
Operating temperature range		T_{amb}	- 40 to + 100	$^\circ\text{C}$
Storage temperature range		T_{stg}	- 40 to + 100	$^\circ\text{C}$
Thermal resistance junction/ ambient	mounted on PC board (pad size > 5 mm ²)	R_{thJA}	270	K/W
		R_{thJA}	290	K/W

Optical and Electrical Characteristics

$T_{amb} = 25\text{ }^{\circ}\text{C}$, unless otherwise specified

Pure green

TLMPG3200

Parameter	Test condition	Symbol	Min	Typ.	Max	Unit
Luminous intensity	$I_F = 50\text{ mA}$	I_V	25	50		mcd
Luminous flux	$I_F = 50\text{ mA}$	I_V		140		mlm
Dominant wavelength	$I_F = 50\text{ mA}$	λ_d	555	564	567	nm
Peak wavelength	$I_F = 50\text{ mA}$	λ_p		565		nm
Spectral bandwidth at 50 % $I_{rel\ max}$	$I_F = 50\text{ mA}$	$\Delta\lambda$		15		nm
Angle of half intensity	$I_F = 50\text{ mA}$	ϕ		± 60		deg
Forward voltage	$I_F = 50\text{ mA}$	V_F		2.2	2.6	V
Reverse current	$V_R = 5\text{ V}$	V_R		0.01	10	μA

Yellow green

TLMYG3200

Parameter	Test condition	Symbol	Min	Typ.	Max	Unit
Luminous intensity	$I_F = 50\text{ mA}$	I_V	63	130		mcd
Luminous flux	$I_F = 50\text{ mA}$	I_V		380		mlm
Dominant wavelength	$I_F = 50\text{ mA}$	λ_d	566	574	577	nm
Peak wavelength	$I_F = 50\text{ mA}$	λ_p		576		nm
Spectral bandwidth at 50 % $I_{rel\ max}$	$I_F = 50\text{ mA}$	$\Delta\lambda$		20		nm
Angle of half intensity	$I_F = 50\text{ mA}$	ϕ		± 60		deg
Forward voltage	$I_F = 50\text{ mA}$	V_F		2.2	2.6	V
Reverse current	$V_R = 5\text{ V}$	V_R		0.01	10	μA

Typical Characteristics ($T_{amb} = 25\text{ }^{\circ}\text{C}$ unless otherwise specified)

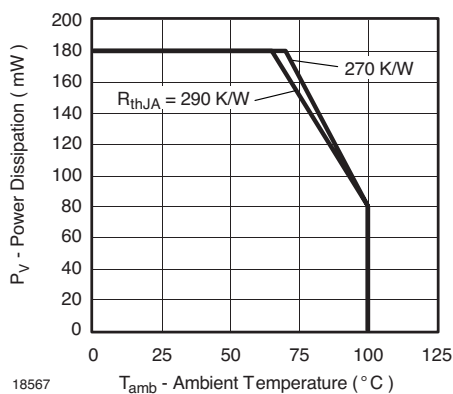

Figure 1. Power Dissipation vs. Ambient Temperature

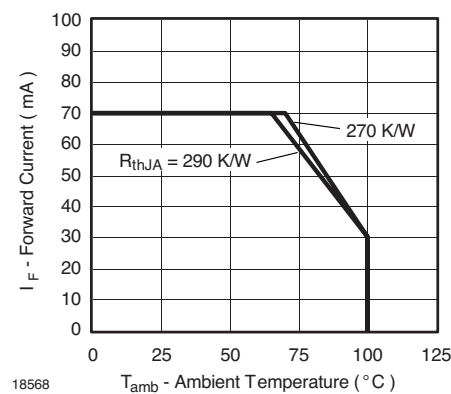

Figure 2. Forward Current vs. Ambient Temperature

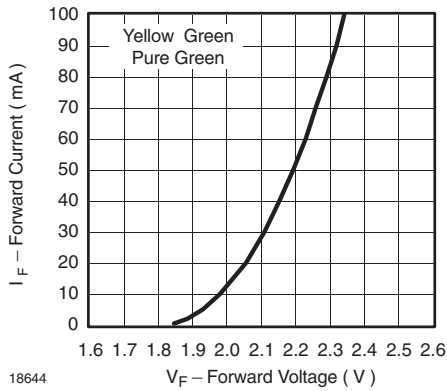

Figure 3. Forward Current vs. Forward Voltage

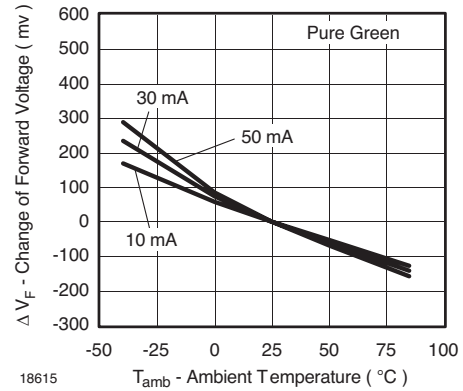

Figure 6. Change of Forward Voltage vs. Ambient Temperature

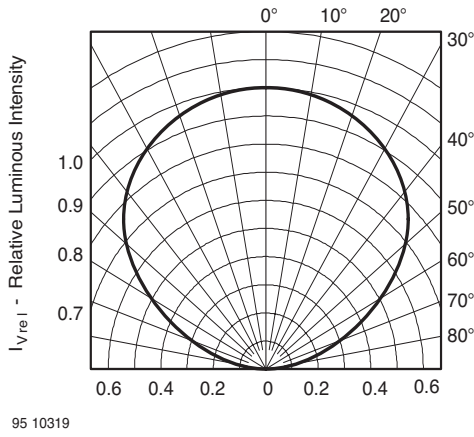

Figure 4. Rel. Luminous Intensity vs. Angular Displacement

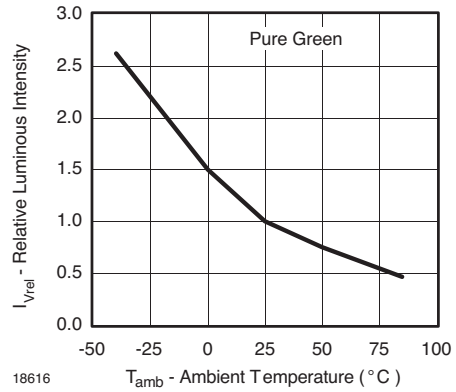

Figure 7. Rel. Luminous Intensity vs. Ambient Temperature

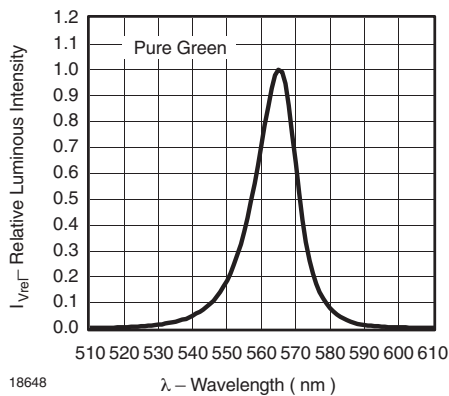

Figure 5. Relative Luminous Intensity vs. Wavelength

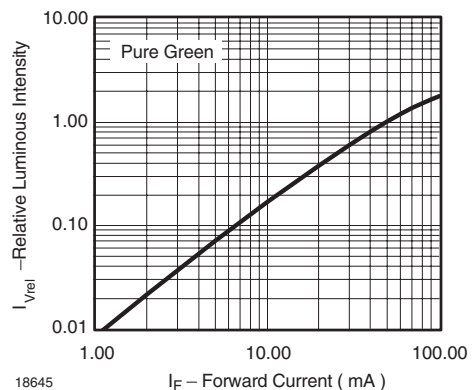

Figure 8. Relative Luminous Intensity vs. Forward Current

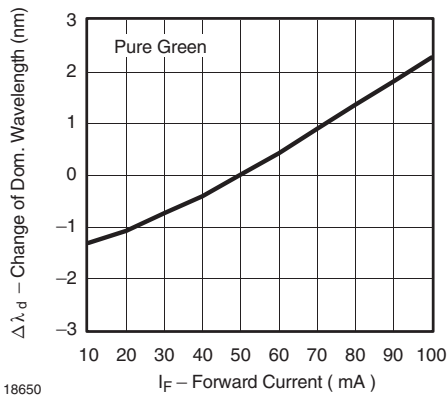

Figure 9. Change of Dominant Wavelength vs. Forward Current

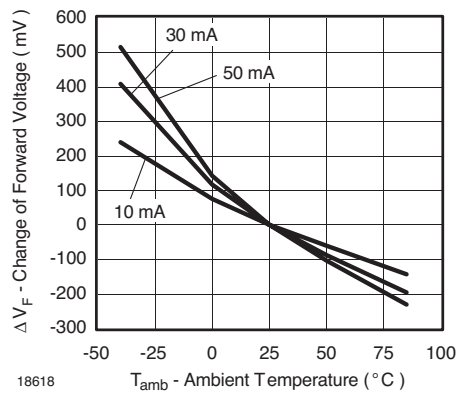

Figure 12. Change of Forward Voltage vs. Ambient Temperature

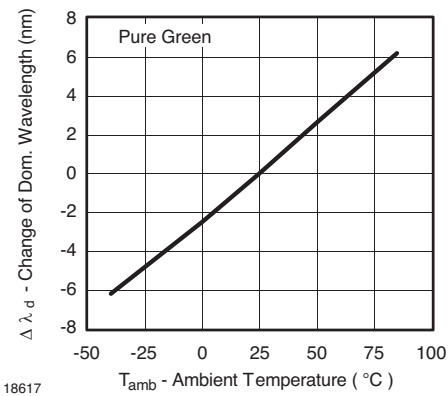

Figure 10. Change of Dominant Wavelength vs. Ambient Temperature

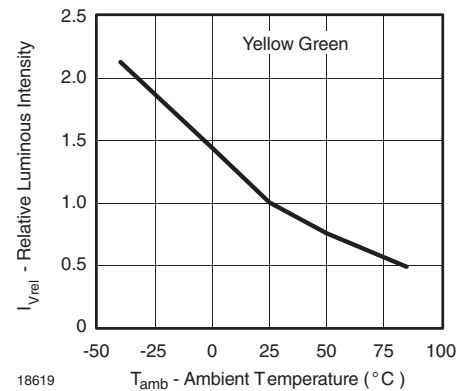

Figure 13. Rel. Luminous Intensity vs. Ambient Temperature

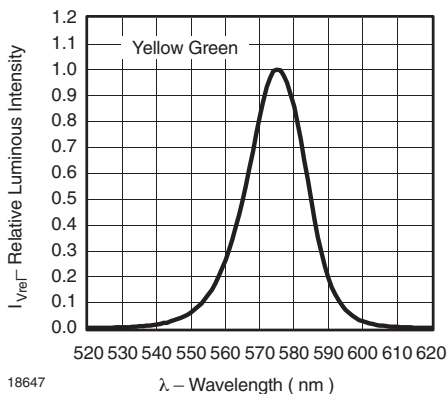

Figure 11. Relative Luminous Intensity vs. Wavelength

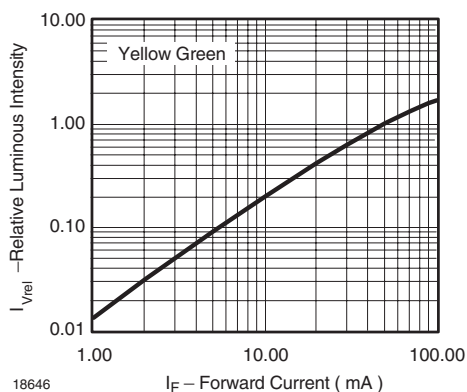

Figure 14. Relative Luminous Intensity vs. Forward Current

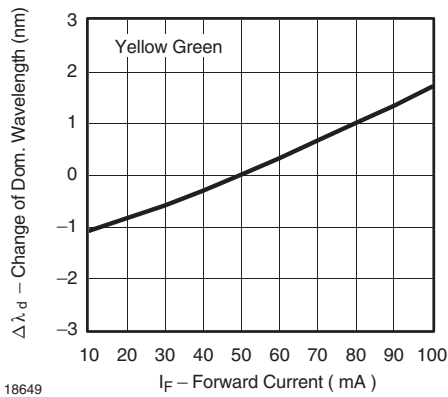

Figure 15. Change of Dominant Wavelength vs. Forward Current

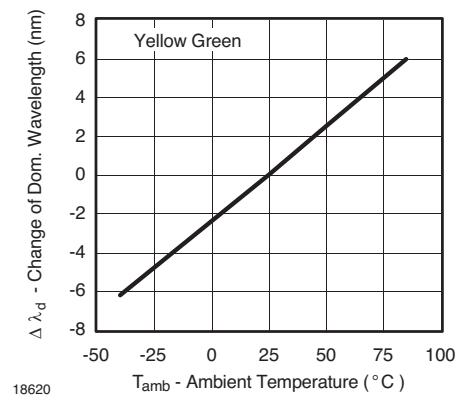
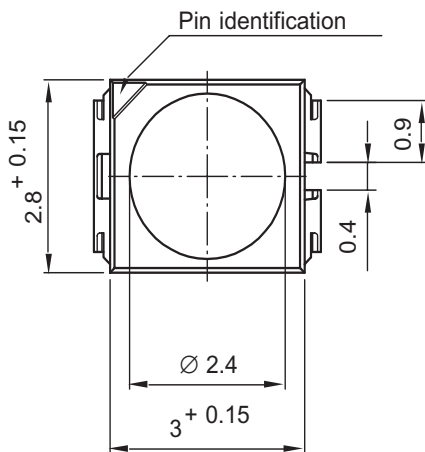
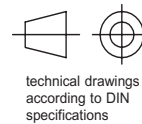
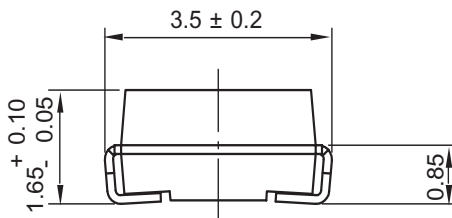

Figure 16. Change of Dominant Wavelength vs. Ambient Temperature

Package Dimensions in mm



Drawing-No. : 6.541-5054.01-4
Issue: 1; 19.02.04

16276

Mounting Pad Layout

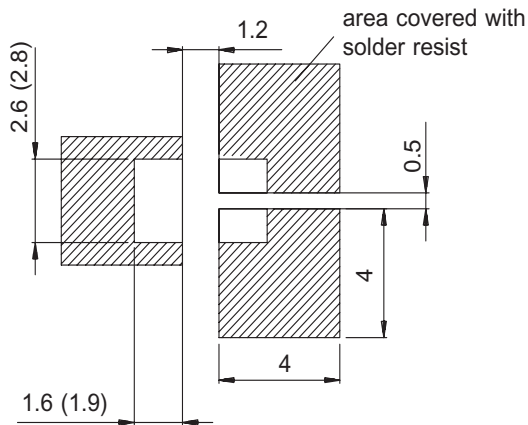

Dimensions: IR and Vaporphase
(Wave Soldering)

Ozone Depleting Substances Policy Statement

It is the policy of **Vishay Semiconductor GmbH** to

1. Meet all present and future national and international statutory requirements.
2. Regularly and continuously improve the performance of our products, processes, distribution and operating systems with respect to their impact on the health and safety of our employees and the public, as well as their impact on the environment.

It is particular concern to control or eliminate releases of those substances into the atmosphere which are known as ozone depleting substances (ODSs).

The Montreal Protocol (1987) and its London Amendments (1990) intend to severely restrict the use of ODSs and forbid their use within the next ten years. Various national and international initiatives are pressing for an earlier ban on these substances.

Vishay Semiconductor GmbH has been able to use its policy of continuous improvements to eliminate the use of ODSs listed in the following documents.

1. Annex A, B and list of transitional substances of the Montreal Protocol and the London Amendments respectively
2. Class I and II ozone depleting substances in the Clean Air Act Amendments of 1990 by the Environmental Protection Agency (EPA) in the USA
3. Council Decision 88/540/EEC and 91/690/EEC Annex A, B and C (transitional substances) respectively.

Vishay Semiconductor GmbH can certify that our semiconductors are not manufactured with ozone depleting substances and do not contain such substances.

**We reserve the right to make changes to improve technical design
and may do so without further notice.**

Parameters can vary in different applications. All operating parameters must be validated for each customer application by the customer. Should the buyer use Vishay Semiconductors products for any unintended or unauthorized application, the buyer shall indemnify Vishay Semiconductors against all claims, costs, damages, and expenses, arising out of, directly or indirectly, any claim of personal damage, injury or death associated with such unintended or unauthorized use.

Vishay Semiconductor GmbH, P.O.B. 3535, D-74025 Heilbronn, Germany
Telephone: 49 (0)7131 67 2831, Fax number: 49 (0)7131 67 2423