

Industrial Grade AC/DC Power Supply With PFC

85-264 Vrms Input Voltage	12/24/36/48 V Semi-Regulated Output	300 W Output Continuous	400 W Output Transient	Up to 91% Full Load Efficiency
------------------------------	----------------------------------------	----------------------------	---------------------------	-----------------------------------



300 W Open Frame



900 W Encased Stacked



300 W Encased

Configurations

- 300 W Encased or Open Frame
- 600 W Encased Flat or Stacked
- 900 W Encased Flat or Stacked



600 W Encased Flat

Product Features

- High efficiency (91% for 48 VOUT Model at 300 W)
- Universal input voltage range
- Semi-regulated output for bus stability
- Parallel operation supported
- Integral fan cooling with speed control
- Active PFC; EN61000-3-2 compliant
- Low leakage; EN60601-1 compliant
- Low noise; EN55011 / EN55022 Class B compliant
- Over-current, over-voltage, & over-temp protection
- DC Power Good / AC Power Good signals
- Remote enable input
- Fan status output / Fan enable input
- Small size: 3" x 5" x 1.45" (open frame)
- RoHS 6/6 compliant
- 5 V (250 mW) standby output



Technical Specification

AC Input: 85-264 Vrms
DC Output: 12/24/36/48 V Semi-reg.
Power: 300 W
Grade: Industrial

ACuQor 300 W Single Vout Series Electrical Characteristics

All specifications typical with $T_A = 25\text{ }^\circ\text{C}$, unless otherwise specified.

MAIN OUTPUT SPECIFICATIONS			GENERAL SPECIFICATIONS		
Output power (continuous) (5 s transient)	85-132/170-264 Vrms	300 W	Fundamental ripple freq.	Input	500 kHz
	85-132/170-264 Vrms	400 W		Output	250 kHz
	132-170 Vrms	See Figures 10		Audible noise	Fan speed varies with temp.
Nominal DC output voltage (at 250W) (Semi-regulated)	12 Vout	12.4 V	Weight (EA \ EC) (SC \ RC) (UC \ TC)	343 g (12.1 oz) \ 446 g (15.7 oz)	
	24 Vout	25 V		846 g (29.8 oz) \ 879 g (31 oz)	
	36 Vout	37.5 V		1224 g (43.2 oz) \ 1298 g (45.8 oz)	
	48 Vout	50 V			
Efficiency (see figs. 3 - 10)	12 Vout, 115 Vrms, 300 W	89% typ.	MTBF	MIL-217	343.6 kHours
	48 Vout, 115 Vrms, 300 W	90% typ.		Demonstrated	TBD kHours
	12 Vout, 230 Vrms, 300 W	90% typ.	ISOLATION SPECIFICATIONS		
	48 Vout, 230 Vrms, 300 W	91% typ.	Isolation voltage		
Hold-up time (to -20%)	12 Vout	16 ms @ 300 W	Input to output		
	24 / 36 / 48 Vout	20 ms @ 300 W	Input to ground		
Maximum load capacitance	12 Vout	16,000 μF	Output to ground		
	24 Vout	8,000 μF	Insulation resistance		
	36 Vout	4,000 μF	Output to ground		
	48 Vout	2,000 μF	Leakage currents		
Output ripple voltage	Switching frequency (20 MHz BW)	0.5% p-p	See Note 2		
	Twice line frequency (at 300W)	5.0% p-p	ENVIRONMENTAL CHARACTERISTICS		
Turn-on delay	2 s max.		Thermal performance		
Transient response	Iout steps from 50-75%	3% typ / 6% max. dev.	Operating ambient (see Figure 9)		
	At 0.2 A/ μs	100 ms recovery	Non-operating ambient		
Overvoltage protection	Cyclic restart	110-120%	Relative humidity		
Short circuit protection	Cyclic operation	115% rated Iout	Non-condensing		
			5-95% RH		
Total regulation	Over line, load and temperature	$\pm 6.0\%$	Altitude		
			Operating		
Auxilliary Output	Always on (See Note 1)	5 V @ 50 mA	Non-operating		
Thermal protection	Automatic recovery	$+125\text{ }^\circ\text{C}$ (PCB Temp)	Random vibration		
			5-500 Hz		
REMOTE_ENABLE	Input Low Voltage	0.45 V (max)	Shock		
	Input High Voltage	4.15 V (min)	Half-sine, 10 ms, 3 axes		
INPUT SPECIFICATIONS			EMC CHARACTERISTICS		
AC input voltage	Universal range	85-264 Vrms	Conducted emissions		
Input frequency	47-63 Hz		EN55011 and EN55022, FCC part15		
Input current	115 Vrms @ 300 W	3 Arms	Line frequency harmonics		
	230 Vrms @ 300 W	1.5 Arms	EN61000-3-2		
Power factor	>0.98		Voltage fluctuations		
			EN61000-3-3		
Input surge current	40 A max.		ESD air		
			EN61000-4-2		
Internal input fuses	6.3 A		ESD contact		
			EN61000-4-2		
			Radiated immunity		
			EN61000-4-3		
			Fast transients		
			EN61000-4-4		
			Line surge immunity		
			EN61000-4-5		
			Conducted immunity		
			EN61000-4-6		
			Power freq. mag. field		
			EN61000-4-8		
			Voltage dip immunity		
			EN61000-4-11		

- NOTES:
- Derate 1 mA per $^\circ\text{C}$ above $50\text{ }^\circ\text{C}$ ambient temperature.
 - Leakage currents see page 5.

EFFICIENCY, DERATING, AND VOUT DROOP CURVES

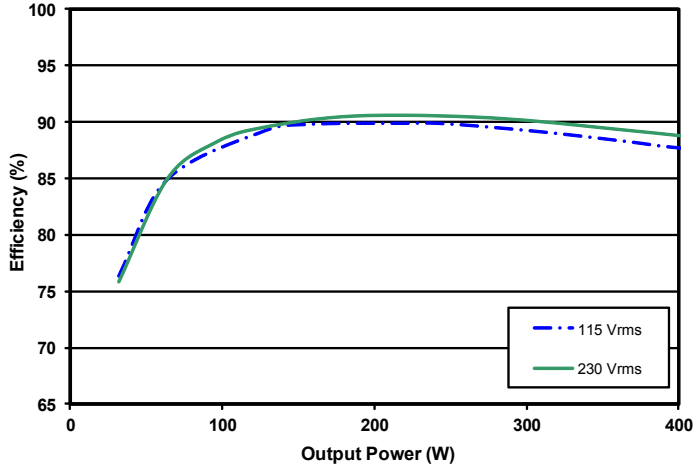

Figure 1: 12 V_{OUT} efficiency curves.

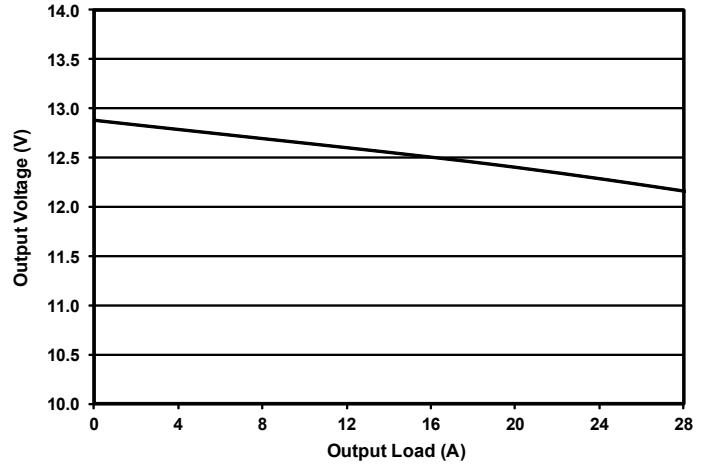

Figure 2: 12 V_{OUT} droop characteristic.

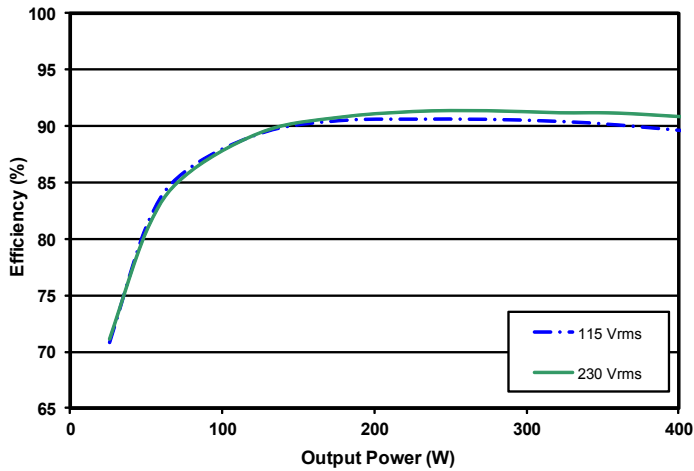

Figure 3: 24 V_{OUT} efficiency curves.

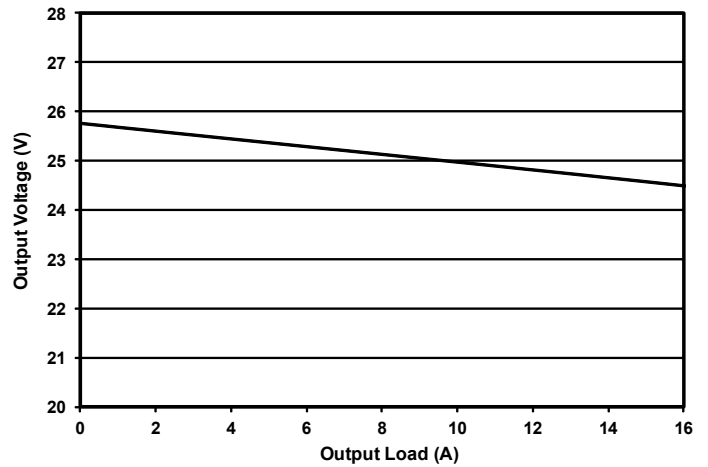

Figure 4: 24 V_{OUT} droop characteristic.

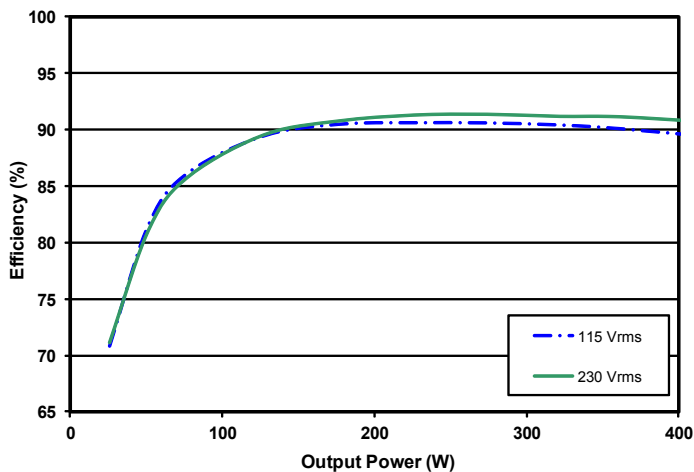

Figure 5: 36 V_{OUT} efficiency curves.

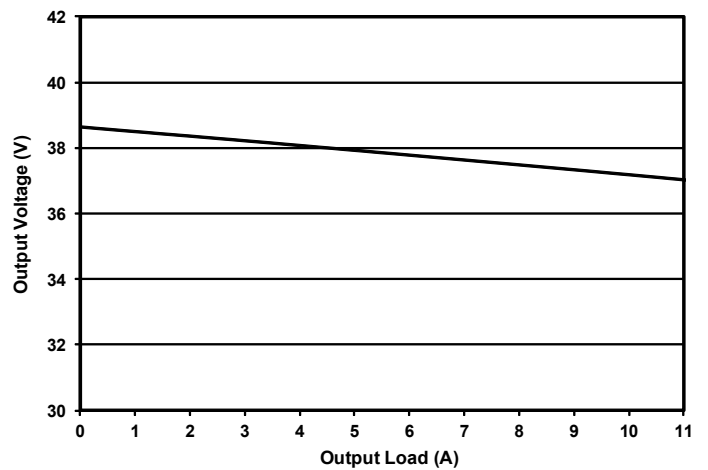

Figure 6: 36 V_{OUT} droop characteristic.



Technical Specification

AC Input: 85-264 Vrms
DC Output: 12/24/36/48 V Semi-reg.
Power: 300 W
Grade: Industrial

EFFICIENCY, DERATING, AND VOUT DROOP CURVES

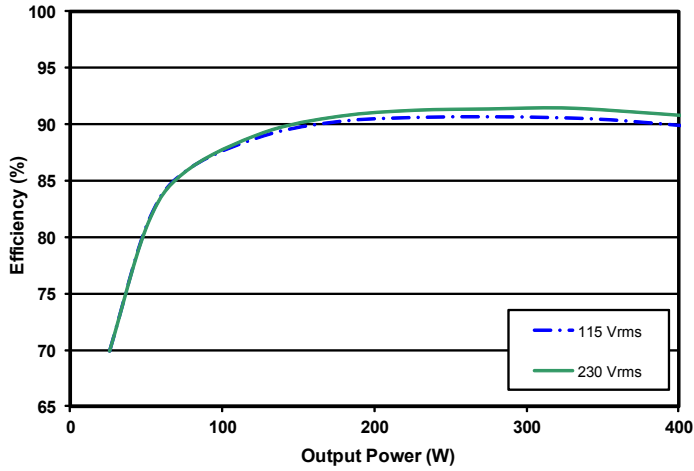

Figure 7: 48 V_{OUT} efficiency curves.

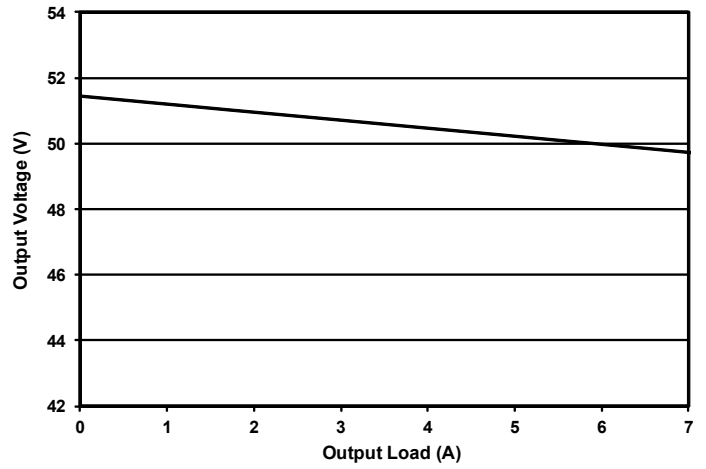

Figure 8: 48 V_{OUT} droop characteristic.

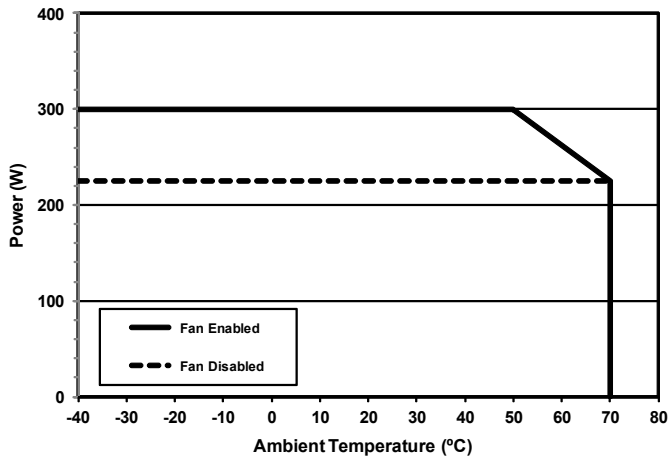

Figure 9: Continuous power derating curve in natural convection.

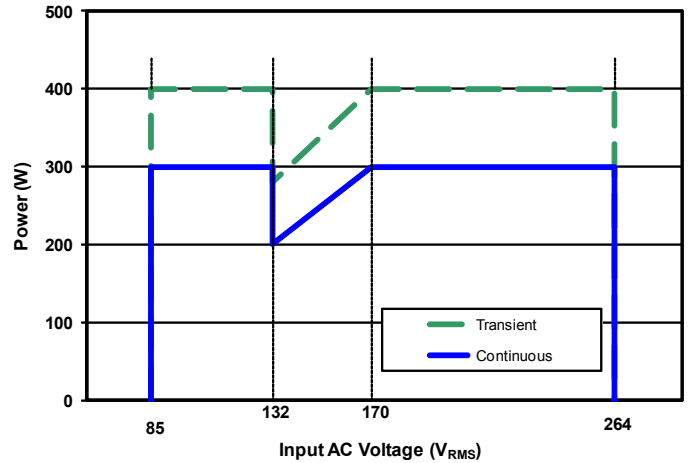

Figure 10: Rated output power vs Input AC Voltage



Technical Specification

AC Input: 85-264 Vrms
DC Output: 12/24/36/48 V Semi-reg.
Power: 300 W
Grade: Industrial

Leakage Currents

AC Leakage Current from Input to Earth	AC Line Connection	Normal Condition	Open Neutral Fault
ACuQor Typical at 110% nominal input voltage 60 Hz	240 V L-N, 1 phase	400 μ A	800 μ A
	208 V L-L, 120 V L-N, 1 of 3 phases	200 μ A	400 μ A
	240 V L-N-L, 120 V L-N, split phase	200 μ A	400 μ A

Standard Testing Certifications

SAFETY AGENCY CERTIFICATIONS

CAN/CSA-C22.2 No. 60950-1:2007

UL 60950-1:2007

EN 60950-1/A1:2010

CE Marked

CONNECTOR DETAILS

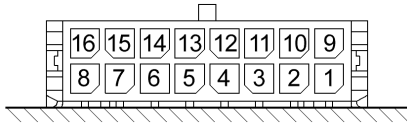

OUTPUT CONNECTOR PINOUT (top side)

Pin 1	FAN_GOOD	Open collector with internal 5V pullup. See Figure A. Pulsed low on fan failure, 100ms, 50% duty. Short to VOUT(-) to disable fan.
Pin 2	AC_POWER_GOOD	Open collector with internal 5V pullup. See Figure B. Pulled low on AC power dropout.
Pin 3	DC_POWER_GOOD	Open collector with internal 5V pullup. See Figure B. Pulled low during startup ramp and within 5 °C of temperature shutdown threshold.
Pin 4	5V_STANDBY	5 V @ 50mA available whenever AC power is applied.
Pin 5	VOUT(+)	Positive Output Voltage.
Pin 6	VOUT(+)	Positive Output Voltage.
Pin 7	VOUT(+)	Positive Output Voltage.
Pin 8	VOUT(+)	Positive Output Voltage.
Pin 9	Reserved	Reserved for future use.
Pin 10	Reserved	Reserved for future use.
Pin 11	REMOTE_ENABLE	Logic input. See Figure C. Pull high to enable main output.
Pin 12	VOUT(-)	Negative Output Voltage.
Pin 13	VOUT(-)	Negative Output Voltage.
Pin 14	VOUT(-)	Negative Output Voltage.
Pin 15	VOUT(-)	Negative Output Voltage.
Pin 16	VOUT(-)	Negative Output Voltage.

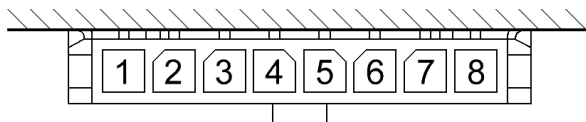

12 V OUTPUT CONNECTOR PINOUT (bottom side)

Pin 1	VOUT(+)	Positive Output Voltage.
Pin 2	VOUT(+)	Positive Output Voltage.
Pin 3	VOUT(+)	Positive Output Voltage.
Pin 4	VOUT(+)	Positive Output Voltage.
Pin 5	VOUT(-)	Negative Output Voltage.
Pin 6	VOUT(-)	Negative Output Voltage.
Pin 7	VOUT(-)	Negative Output Voltage.
Pin 8	VOUT(-)	Negative Output Voltage.

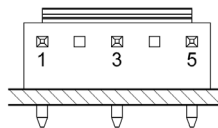

INDIVIDUAL INPUT CONNECTOR PINOUT

Pin 1	Ground
Pin 3	AC Neutral
Pin 5	AC Line

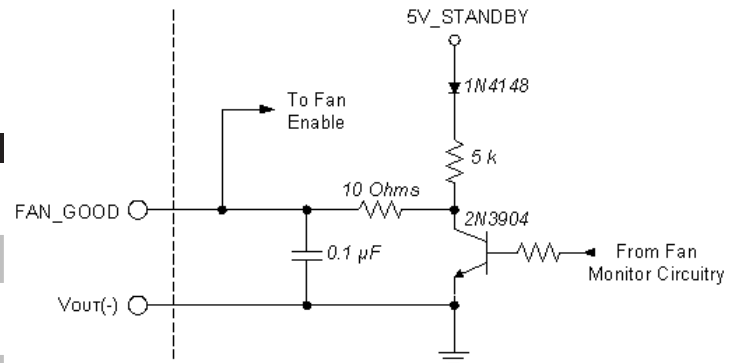

Figure A: Fan status output / Fan enable input interface circuitry.

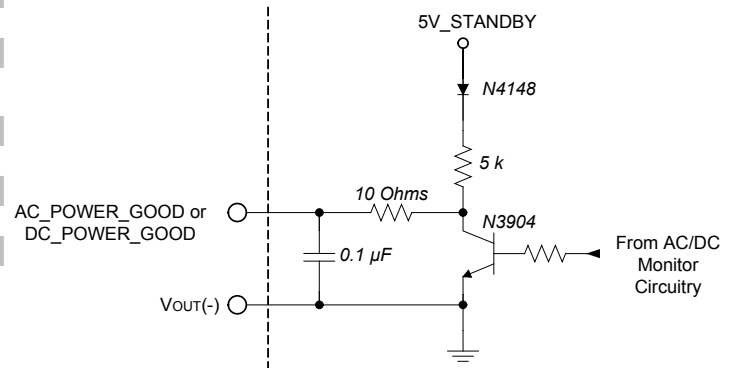

Figure B: Power good interface circuitry.

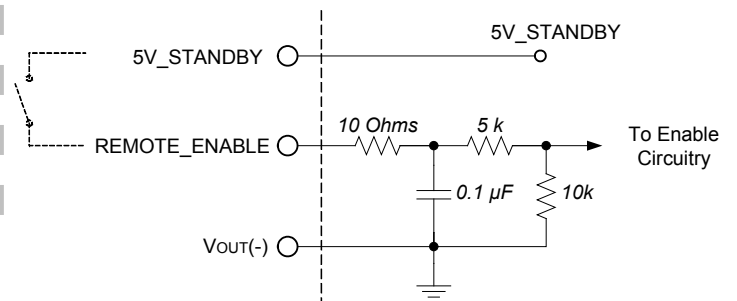

Figure C: Remote enable interface circuitry.

MATING CONNECTORS

Connector	Type	Contact
OUTPUT (16 pins)	Molex 430251600	Molex 430300008*
12V_OUTPUT (8 pins)	Molex 436450800	Molex 430300008*
INPUT	JST VHR-5N	JST SVH-41T-P1.1

* Each contact rated for a maximum of 5.5 A.



Technical Specification

AC Input: 85-264 Vrms
DC Output: 12/24/36/48 V Semi-reg.
Power: 300 W
Grade: Industrial

MECHANICAL DRAWINGS

(1 Module Open Frame Version — E Package Type)

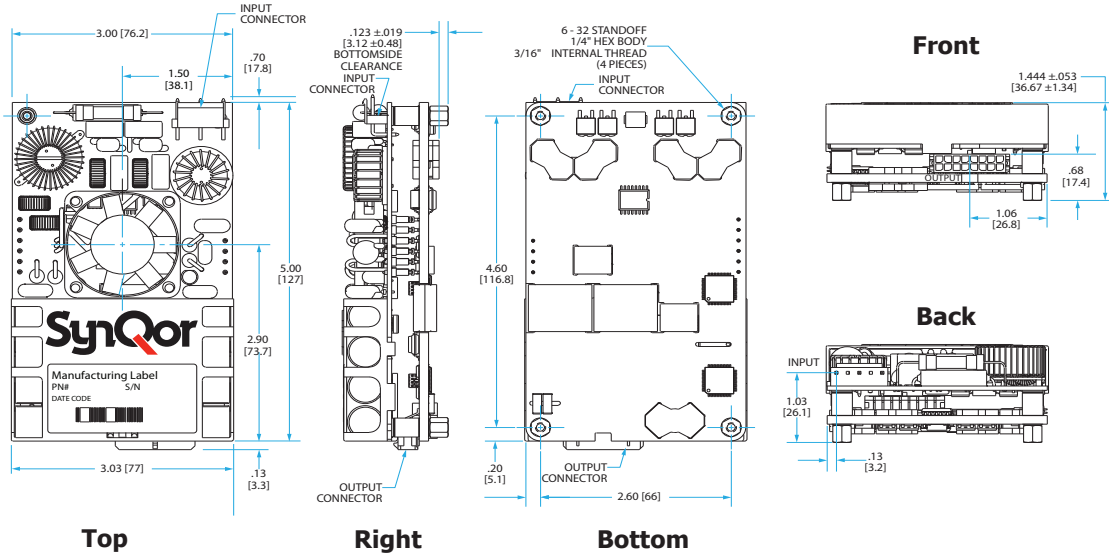

(1 Module Encased Version — E Package Type)

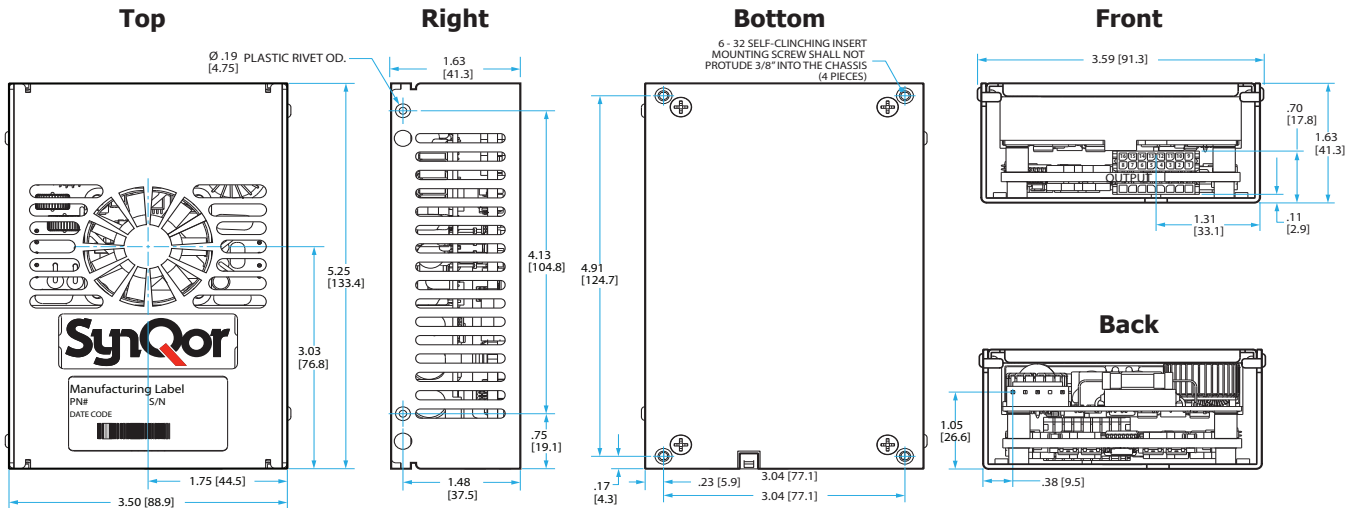

NOTES (applies to all mechanicals)

- 1) Recommended screw tightening torque of 6 in.lbs
- 2) Undimensioned components are shown for visual reference only
- 3) All dimensions in inches [mm]

Tolerances: x.xx in ± 0.02
 x.xxx in ± 0.010



Technical Specification

AC Input: 85-264 Vrms
DC Output: 12/24/36/48 V Semi-reg.
Power: 300 W
Grade: Industrial

MECHANICAL DRAWINGS

(2 Modules Flat Version - R Package Type)

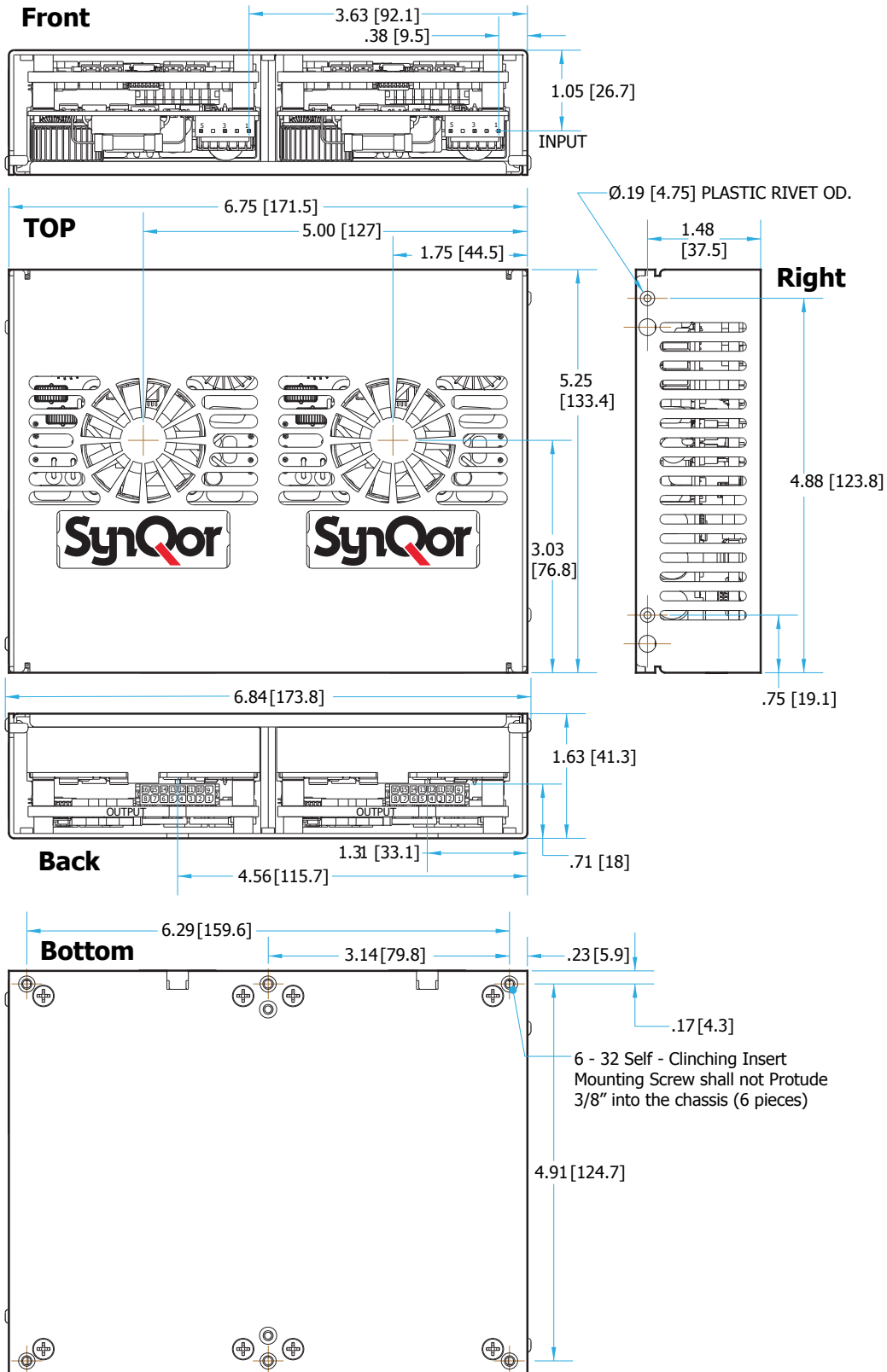



Technical Specification

AC Input: 85-264 Vrms
DC Output: 12/24/36/48 V Semi-reg.
Power: 300 W
Grade: Industrial

MECHANICAL DRAWINGS

(2 Modules Stacked Version - S Package Type)

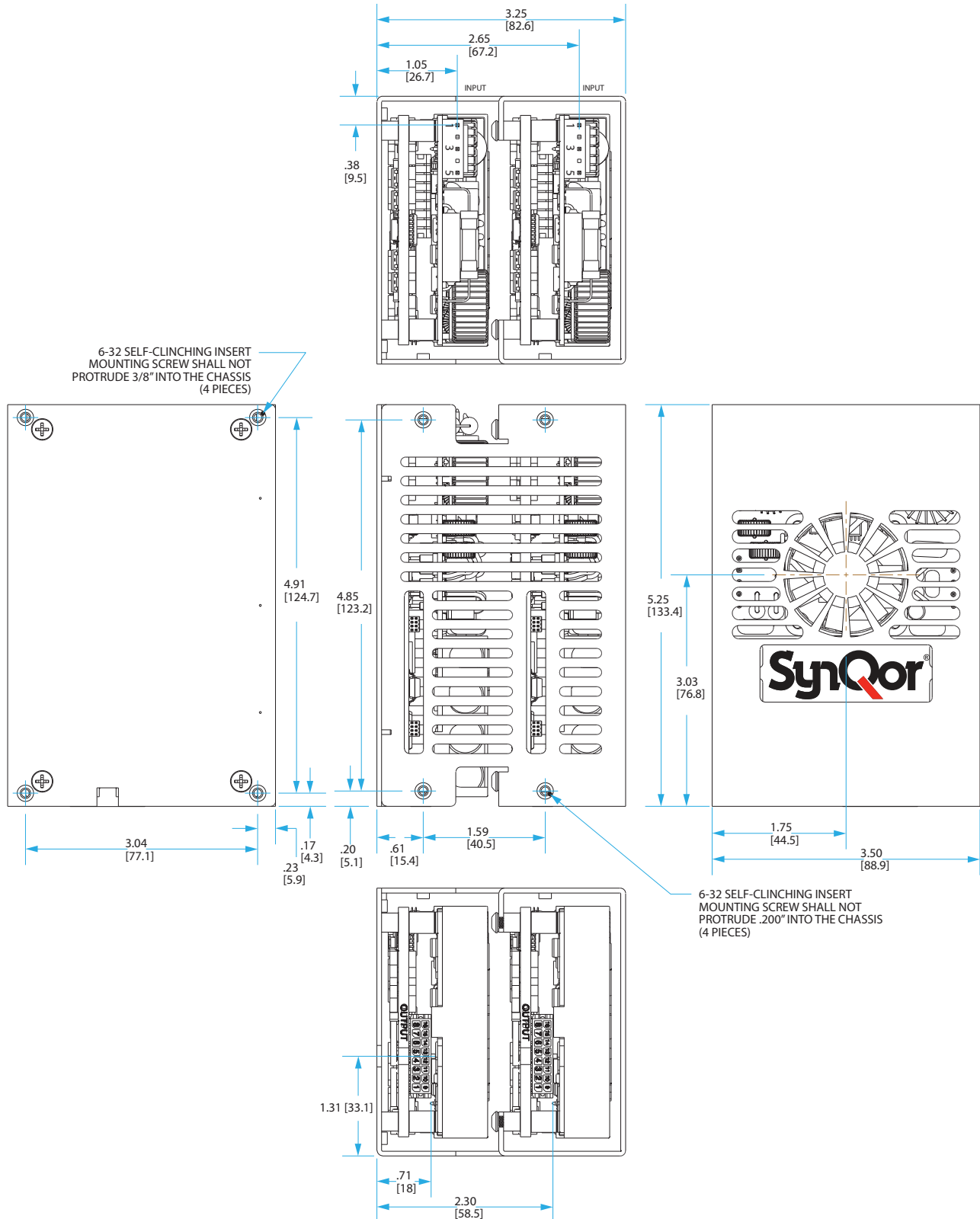



Technical Specification

AC Input: 85-264 Vrms
DC Output: 12/24/36/48 V Semi-reg.
Power: 300 W
Grade: Industrial

MECHANICAL DRAWINGS

(3 Modules Flat Version - T Package Type)

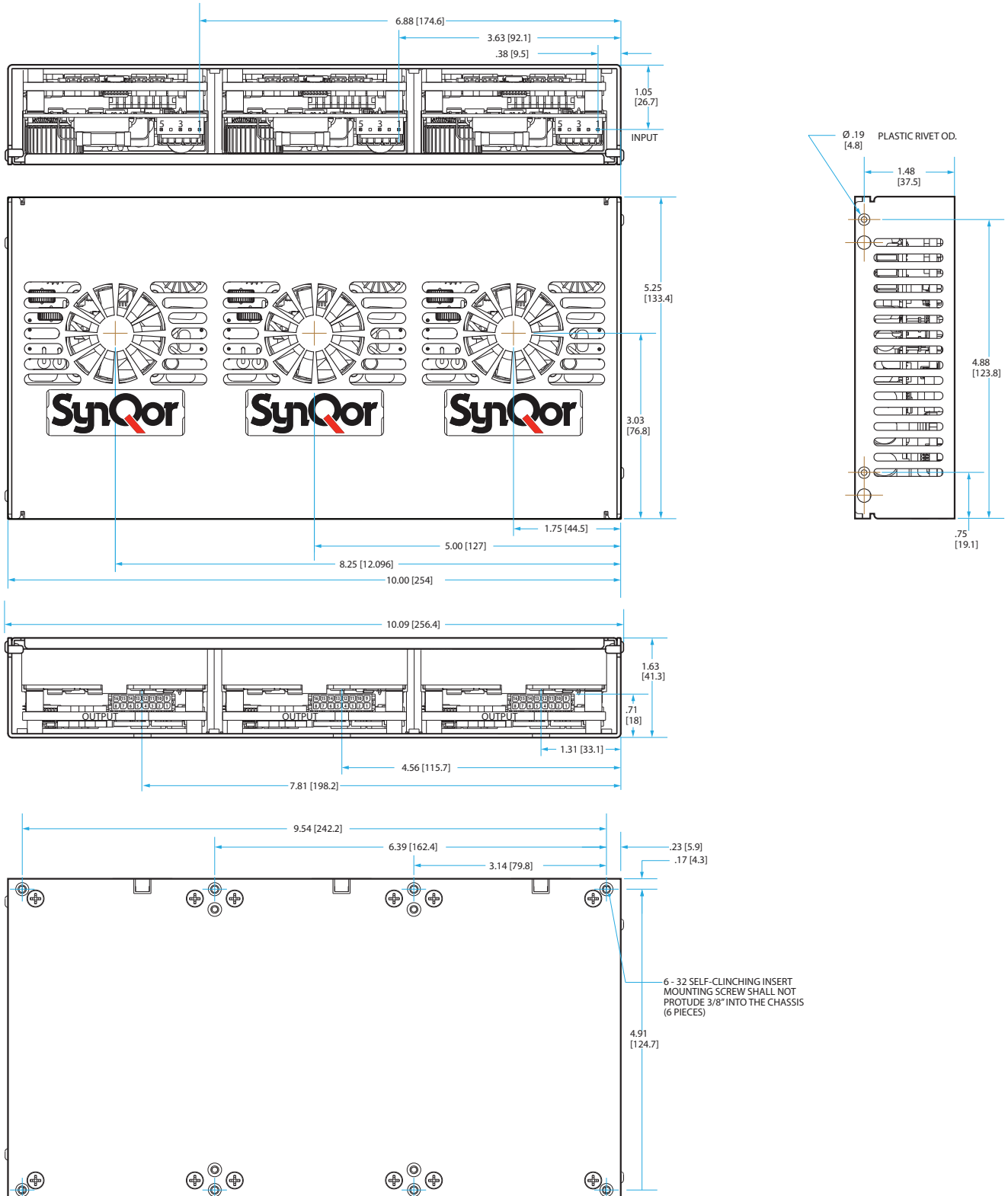



Technical Specification

AC Input: 85-264 Vrms
DC Output: 12/24/36/48 V Semi-reg.
Power: 300 W
Grade: Industrial

MECHANICAL DRAWINGS

(3 Modules Stacked Version - U Package Type)

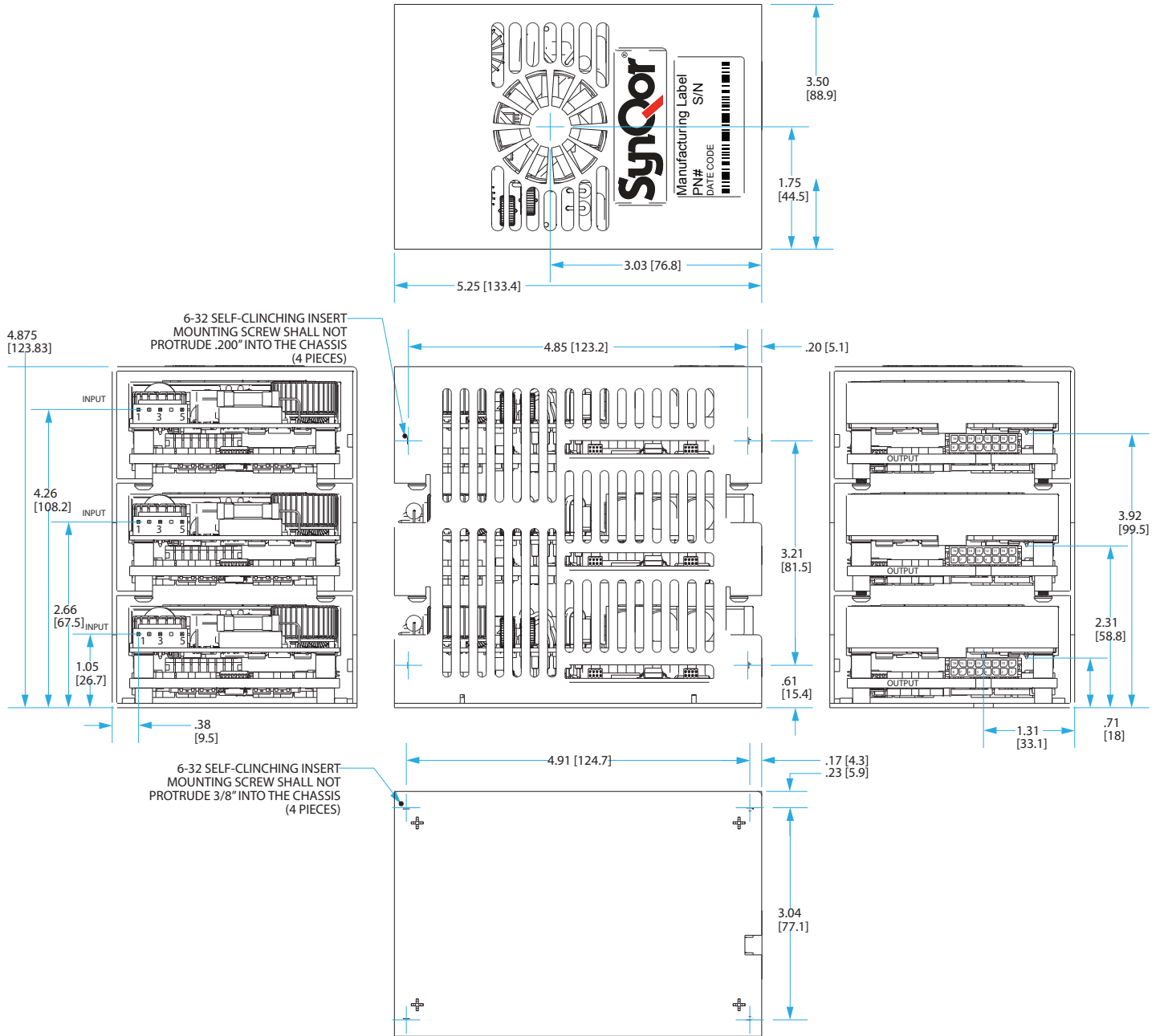



Technical Specification

AC Input: 85-264 Vrms
DC Output: 12/24/36/48 V Semi-reg.
Power: 300 W
Grade: Industrial

PARALLEL OPERATION - MULTIPLE UNITS

Chassis configurations for Parallel Units

ACuQor units are available either open-frame or pre-mounted at the factory. Up to 3 units can be mounted into a chassis, in either side-by-side or stacked configurations. For a complete list of options, see the "Part Numbering System" table on the last page, under "Package Type", along with the Mechanical Drawings pages. Only side-by-side configurations can be populated with 500W units, since each includes a thermal pad underneath.

Interconnection of Parallel Units

ACuQor units mounted in 2 and 3 unit chassis are not connected together. This allows the physical routing and connectivity of the external wiring to be customized to each application. The following table summarizes the recommended wiring to operate multiple units in parallel:

Specifications of Parallel Units

As a rule, units wired in parallel behave the same as single units. Any specification will remain unchanged that is expressed in units of voltage, time, frequency, or efficiency. Specifications expressed in terms of power, current, or capacitance, should be scaled by the number of units wired in parallel.

ACuQor units are individually calibrated at the factory, so that the output voltage vs. output current characteristic is always consistent (see Vout droop characteristic figures). As such, multiple units will share output current accurately. Full current is guaranteed from a bank of multiple units wired in parallel.

Output Connector Signal	Suggested Connection	Behavior with Multiple Units
REMOTE_ENABLE	Wire in parallel	Inputs activated simultaneously
FAN_GOOD	"	Wired-OR outputs – can be pulled low by any unit during an abnormal condition.
AC_POWER_GOOD	"	"
DC_POWER_GOOD	"	"
VOUT(+), VOUT(-)	"	Built-in droop characteristic ensures graceful current sharing.
12V_STANDBY*	"	"
5V_STANDBY	Do not wire in parallel	Fully regulated characteristic does not support current sharing. If placed in parallel, only the output with the highest set-point will drive current.

*Note: Triple output models only.



AC Input: 85-264 Vrms
DC Output: 12/24/36/48 V Semi-reg.
Power: 300 W
Grade: Industrial

INSTALLATION INSTRUCTIONS

General: ACuQor AC/DC power supplies are intended for use as components in industrial equipment. ACuQor units must be properly installed within end use equipment before they can be safely applied as described in this document. The suitability of the ACuQor/equipment combination must be verified through end product investigation.

Mounting: Refer to the Mechanical Drawings section. ACuQor units are provided with threaded stainless-steel stand-offs or inserts for mounting. This mounting hardware is internally connected to the input connector protective-earth terminal for functional-earth EMC control. Any orientation (vertical, horizontal, etc.) may be used. Adequate air space should be provided over the fan intake (top) and exhaust (sides) to allow for exchange of cooling air. ACuQor is designed for a pollution degree 2 environment. The suitability of the enclosed ACuQor mechanical assemblies must be verified through end product investigation.

Encased models: A minimum of 5 mm electrical clearance should be allowed from the connector ends of encased models.

Input: Refer to the Connector Details section for input connector wiring. ACuQor products require a single phase AC power source of 100-240V 50/60Hz nominal. Refer to nameplate label for input current ratings. A protective-earth connection is also required. Minimum wire size of 18 AWG (0.8mm²) is recommended. Both sides of the AC line are internally fused (see table for specific models). These fuses are not user replaceable.

MODEL	Input Fuses (in Both AC Lines)	Fuses Total
AQ0300	Littelfuse 6.3A 250V 21606.3XEP	2
AQ0400	Littelfuse 6.3A 250V 21606.3XEP	2
AQ0500	Littelfuse 10.0A 250V 216010XEP	2

Output: Refer to the Connector Details section for output connector wiring and signal I/O functionality. Refer to nameplate label for output current ratings. Main DC output (Vout+, Vout-) pins should use 20 AWG (0.5mm²) wire size. Individual main output pins should not be loaded to more than 5.5 A. For currents greater than 5.5 A, multiple main output pins/wires must be used in parallel. All signal I/O pins are referenced to Vout-.

EMC: ACuQor products have been tested to the EMC specifications listed in the Electrical Characteristics section. However, end use equipment must be tested to verify EMC compliance.

Hipot Testing: ACuQor products are rated for Hipot testing levels of 1500 Vac input to protective-earth, 500 Vac output to protective-earth, and 3000 Vac input to output. When performing the 3000 Vac input to output test, the test voltage must be balanced evenly 1500 Vac input and output to protective-earth. Two oppositely phased test voltage sources or a single test voltage source with external balancing impedances (capacitors) may be used to prevent overstressing input or output to protective-earth insulation per IEC/ENC 60950-1.

SynQor®

Ordering Information

AC Input: 85-264 Vrms
DC Output: 12/24/36/48 V Semi-reg.
Power: 300 W
Grade: Industrial

PART NUMBERING SYSTEM

The part numbering system for SynQor's ACuQor AC/DC power supplies follows the format shown in the table below. Not all combinations make valid part numbers, please contact SynQor for availability.

Family	Output Power	Grade	Range	Output Voltage	Package Type	Thermal Design	Options
AQ: ACuQor series of AC-DC semi-regulated output power supplies	0300: 300 W 0400: 400 W 0500: 500 W 0600: 600 W (2 x 300 W) 0800: 800 W (2 x 400 W) 0900: 900 W (3 x 300 W) 1000: 1000 W (2 x 500 W) 1200: 1200 W (3 x 400 W) 1500: 1500 W (3 x 500 W)	I: (Industrial)	U: Universal (85-264 VRMS)	12: 12 V 1T: 12 V / 5 & 12 V STBY 24: 24 V 2T: 24 V / 5 & 12 V STBY 36: 36 V 3T: 36 V / 5 & 12 V STBY 48: 48 V 4T: 48 V / 5 & 12 V STBY	E: 1 unit (3"x5") R: 2 units; flat S: 2 units; stacked T: 3 units; flat U: 3 units; stacked	A: Open frame C: Encased	Industrial Grade: IND: Industrial

Example: AQ0300IU12EAIND

ACCESSORIES

SynQor offers a series of assemblies that can be ordered according to the table below. Mechanical drawings for these accessories are available for download in pdf format from the SynQor website.

Part Number	Description
AQ-CBL-INPUT1C	Input mating cable with pre-stripped wire ends (36" long).
AQ-CBL-OUT1C	Output mating cables with pre-stripped wire ends (18" long).
AQ-CBL-OUT1CD	Same as AQ-CBL-OUT1C with an additional 8-pins connector.
AQ-CBL-OUT2C	Output mating cable with connectors on both ends (18" long).
AQ-CBL-OUT2CD	Same as the AQ-CBL-OUT2C with an additional 8-pins connector.
AQ-INSUL1M	Single module bottom-side Mylar insulator for open frame mounting
AQ-EVAL-PRL3	Evaluation board for up to three paralleled modules.

APPLICATION NOTES

A variety of application notes and technical white papers can be downloaded in pdf format from the SynQor website.

[Online Application Notes](#)

[Online Library of Technical White Papers](#)

[SynQor website.](#)

Contact SynQor for further information and to order:

Phone: 978-849-0600
Toll Free: 888-567-9596
Fax: 978-849-0602
E-mail: power@synqor.com
Web: www.synqor.com
Address: 155 Swanson Road
 Boxborough, MA 01719
 USA

PATENTS

SynQor holds numerous U.S. patents, one or more of which apply to most of its power converter products. Any that apply to the product(s) listed in this document are identified by markings on the product(s) or on internal components of the product(s) in accordance with U.S. patent laws. SynQor's patents include the following:

5,999,417	6,222,742	6,545,890	6,594,159	6,731,520	6,894,468
6,896,526	6,927,987	7,050,309	7,072,190	7,085,146	7,119,524
7,269,034	7,272,021	7,272,023	7,558,083	7,564,702	7,765,687
7,787,261	8,023,290	8,149,597	8,493,751	8,644,027	

WARRANTY

SynQor offers a two (2) year limited warranty. Complete warranty information is listed on our website or is available upon request from SynQor.