

Moisture Sensitivity Level (MSL) – 1

OVERVIEW:

Abrakon's ASTXR series of Temperature Compensated Crystal Oscillators are based on an Advanced-Analog Temperature Compensation Integrated Circuit, incorporated with Rakon's Precision TCXO processing techniques.

This composite enables exceptional frequency stability over temperature ($\leq \pm 0.50$ ppm over -40°C to $+85^{\circ}\text{C}$). Additionally, high-resolution screening algorithms are employed during the production verification process, ensuring that 100% of these devices are fully compliant to the stringent frequency stability specifications.

For Power Sensitive applications, the ASTXR series provides the ability to preserve consumed power by placing the device in shut-down mode; when not used. This series of devices are ideally suited for GPS and other mobile applications where performance, size, cost and power management are of critical importance.

FEATURES:

- Excellent phase noise performance
- Low power consumption
- Ultra miniature size: 2.05 x 1.65 x 0.8mm
- RoHS compliant
- Temperature stability: ± 0.5 ppm over $-30 \sim +85^{\circ}\text{C}$

APPLICATIONS:

- GPS
- Smartphone
- PND
- Communications
- Consumer electronics
- Wi-Fi
- WiMAX/W-LAN

STANDARD SPECIFICATIONS:

Parameters	Minimum	Typical	Maximum	Units	Notes
Nominal Frequency	26.000			MHz	
Supply Voltage (Vdd)	1.75	1.9	2.0	V	
Current Consumption (@Vdd max)			1.5	mA	See Note 2
Operable Temperature Range	-40		+85	$^{\circ}\text{C}$	
Storage Temperature Range	-40		+85	$^{\circ}\text{C}$	
Initial Frequency Tolerance + Reflow Drift @ $+25^{\circ}\text{C} \pm 2^{\circ}\text{C}$ at time of shipment			± 2	ppm	After 2 consecutive reflows and 1hr recovery @ $+25^{\circ}\text{C}$
Frequency Stability over -30°C to $+85^{\circ}\text{C}$			± 0.5	ppm	Ref. to $(F_{\text{MAX}} + F_{\text{MIN}}) / 2$. See Note 1
Frequency Stability over -40°C to -30°C			± 1	ppm	Temperature varied at maximum of $2^{\circ}\text{C}/\text{minute}$ over -40°C to $+30^{\circ}\text{C}$
Frequency Slope (tested to a minimum of 1 freq. reading every 2°C over -30°C to $+85^{\circ}\text{C}$)			0.1	ppm/ $^{\circ}\text{C}$	See Note 1
Frequency Slope (tested to a minimum of 1 freq. reading every 2°C over -40°C to -30°C)			0.5	ppm/ $^{\circ}\text{C}$	See Note 1
Static Temperature Hysteresis (Frequency change after reciprocal temperature ramped over the operating range. Frequency measured before and after at $+25^{\circ}\text{C}$)			0.6	ppm	
Sensitivity vs. Supply Voltage Variations (Vdd $\pm 5\%$ @ $+25^{\circ}\text{C}$)			± 0.1	ppm	
Sensitivity vs. Load Variations ($\pm 10\%$ load change @ $+25^{\circ}\text{C}$)			± 0.2	ppm	See Note 2
Long Term Stability (frequency drift over 1 year @ $+25^{\circ}\text{C}$)			± 3	ppm	
G-sensitivity			2	ppb/g	Gamma vector of all 3 axis from 30Hz to 1500Hz
Output Type	DC Coupled Clipped Sine-wave				See Note 3
Output Voltage Level (@ minimum Vdd)	0.8			V	See Note 2
Output Load Resistance	9	10	11	k Ω	
Output Load Capacitance	9	10	11	pF	
Startup Time (amplitude)			0.5	ms	Within 90% of specified output level
Startup Time (frequency)			1.5	ms	Within ± 0.5 ppm of steady state frequency

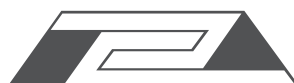

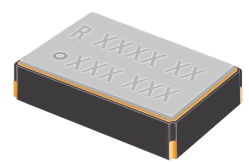

Parameters	Minimum	Typical	Maximum	Units	Notes
Enable/Disable Function (Pin 1)					
Input Voltage High (VIH)	80%*Vdd		Vdd	V	Normal operating Mode
Input Voltage Low (VIL)	GND		20%*Vdd	V	Power Down Mode
Stand-by Current		<0.01	2	μA	
Enable Time (amplitude)			0.5	ms	Within 90% of specified output level
Enable Time (frequency)			2	ms	Within ±0.5ppm of steady state frequency
Phase Noise @ 26MHz Carrier (@+25°C)					
@ 1 Hz offset		-65		dBc / Hz	
@ 10 Hz offset		-93		dBc / Hz	
@ 100 Hz offset		-117		dBc / Hz	
@ 1,000 Hz offset		-137		dBc / Hz	
@ 10,000 Hz offset		-149		dBc / Hz	
@ 100,000 Hz offset		-151		dBc / Hz	

Note:

1. Parts should be shielded from drafts causing unexpected thermal gradients. Temperature changes due to ambient air currents on the oscillator can lead to short term frequency drift
2. Specified for load stated in the Oscillator Output section at +25°C
3. External AC-Coupling capacitor required. ≥ 1nF is recommended
4. Frequency shift ≤ 1ppm after reliability test conditions (see section 7.0)

➤ **REFERENCE DESIGN INFORMATION:**

ASTXR-13-26.000MHz-509764 is equivalent to Rakon P/N 509764.

➤ **PART IDENTIFICATIONS:**

ASTXR-13-26.000MHz -509764 - 

Packing
Blank: Bulk
T: Tape & Reel (4k/reel)

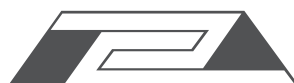

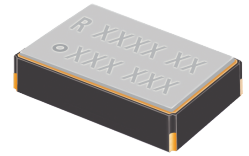

OUTLINE DIMENSION:

TOP VIEW

FRONT VIEW

BOTTOM VIEW

Recommended Land Pattern

External Bypass Cap 100nF
To GND

Output to Circuit

External AC-Coupling Capacitor $\geq 1nF$

Recommended No Tracks Including Plains Under Device

Pin	Function
1	Enable/Disable
2	GND
3	Output
4	Vdd

Dimensions: mm

REFLOW PROFILE:

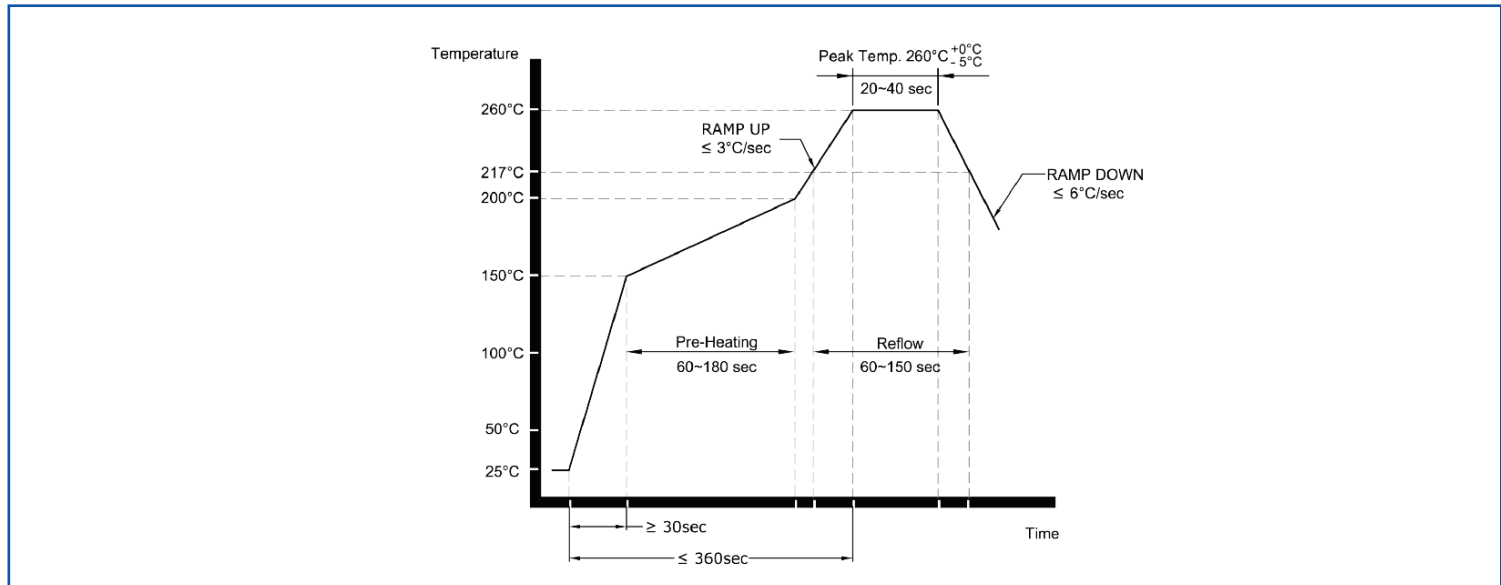

SMD TCXO

ASTXR-13-26.000MHz-509764



RoHS / RoHS II Compliant

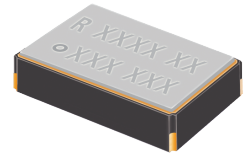

2.05 x 1.65 x 0.8 mm SMD

TAPE & REEL:

4000pcs/reel

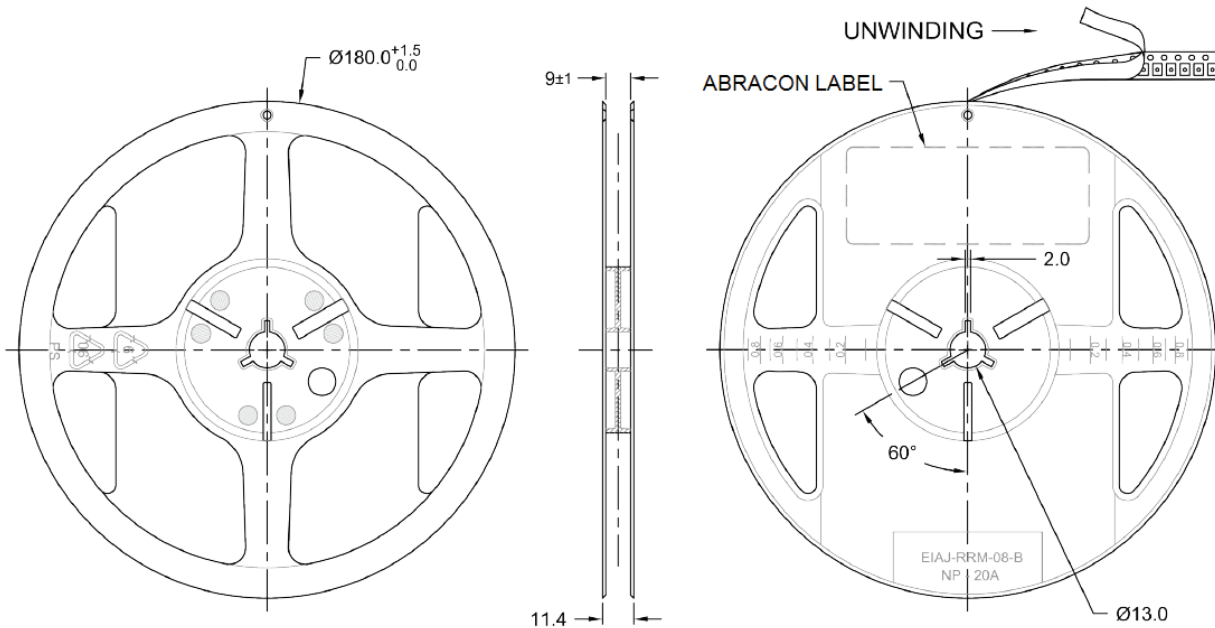
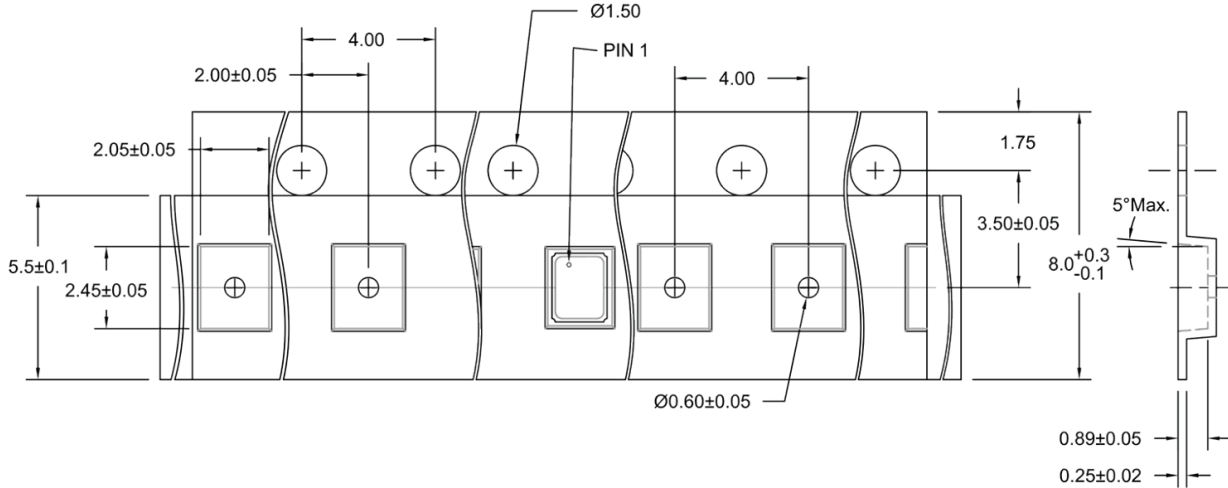

Dimensions: mm

ATTENTION: Abracon Corporation's products are COTS – Commercial-Off-The-Shelf products; suitable for Commercial, Industrial and, where designated, Automotive Applications. Abracon's products are not specifically designed for Military, Aviation, Aerospace, Life-dependant Medical applications or any application requiring high reliability where component failure could result in loss of life and/or property. For applications requiring high reliability and/or presenting an extreme operating environment, written consent and authorization from Abracon Corporation is required. Please contact Abracon Corporation for more information.

ABRACON IS
ISO9001:2008
CERTIFIED



**ABRACON
CORPORATION**

Visit www.abracon.com for Terms & Conditions of Sale
30332 Esperanza, Rancho Santa Margarita, California 92688
tel 949-546-8000 | fax 949-546-8001 | www.abracon.com

Revised: 07.23.14