

150W, wide input voltage, isolated & regulated single output DC-DC converter



Patent Protection RoHS



FEATURES

- Wide input voltage range: 50-160V
- Efficiency up to 91%
- No-load power consumption as low as 3mA
- Isolation voltage 3000VDC
- Operating temperature range: -40°C~+100°C
- Input under-voltage protection, output over-voltage, over-current, short circuit, over-temperature protection
- International standard: 1/2 brick
- Meets requirements of railway standard EN50155

URF1D_HB-150W (H) series is a high performance product designed for the field of railway applications. Output power up to 150W, no min load requirement, wide input voltage 50-160VDC, which allows the base plate operating temperature up to 100°C. Further product features include input under-voltage protection, output over-voltage protection, short circuit protection, over current protection, over temperature protection, remote control and compensated, output voltage regulation functions. Meets the EN50155 railway standard. Widely used in the railway system and associated equipment.

Selection Guide

Part No.	Input Voltage (VDC)			Input Voltage (VDC)		Efficiency (% Min./Typ) @ Full Load	Max. Capacitive Load(μF)
	Nominal	(Range)	Max.*	Output Voltage(VDC)	Output Current (mA)(Max./Min.)		
URF1D24HB-150W	110	(66-160)	170	24	6250/0	89/91	4400
		(50-66)			5000/0		
URF1D24HB-150WH		(66-160)		24	6250/0	89/91	
		(50-66)			5000/0		

Note: *Exceeding the maximum input voltage may cause permanent damage.

Input Specifications

Item	Operating Conditions	Min.	Typ.	Max.	Unit
Input Current (full load / no-load)	Nominal input	--	1495/3	1532/10	mA
Reflected Ripple Current	Nominal input	--	80	--	
Input impulse Voltage (1sec. max.)		-0.7	--	180	VDC
Starting Voltage		--	47	50	
Under-voltage Shutdown Voltage		35	43	50	
Start-up Time		--	25	--	mS
Input Filter		Pi filter			
Ctrl*	Module switch on	Ctrl psuspended or connected to TTL high level (3.5-12VDC)			
	Module switch off	Ctrl connected to -Vin or low level (0-1.2VDC)			
	Input current when switched off	--	2	5	mA
Hot Plug		Unavailable			

Note: * the voltage of Ctrl pin is relative to input pin -Vin.

Output Specifications

Item	Operating Conditions	Min.	Typ.	Max.	Unit
Output Voltage Accuracy	Nominal input, 10%-100% load	--	--	±3	%
Line Regulation	Full load, the input voltage is from low to high	--	--	±0.3	
Load Regulation	Nominal input, 10%-100% load	--	--	±0.5	
Transient Recovery Time	25% load step change	--	300	500	μs
Transient Response Deviation		--	±3	±5	%Vo
Temperature Coefficient	Full load	--	--	±0.03	%/°C

Ripple & Noise *	20MHz bandwidth (with 10%-100% load)	--	60	120	mVp-p
Trim		95	--	110	%Vo
Output voltage remote compensation(Sense)		--	--	105	
Over-voltage Protection	Input voltage range	110	--	140	%Vo
Over-current Protection		110	130	180	%Io
Short circuit Protection	Nominal input	Continuous			

Note: * The measuring method of ripple and noise, please refer to Fig. 2.

General Specifications						
Item	Operating Conditions		Min.	Typ.	Max.	Unit
Isolation Voltage	Input-output	Input-output, with the test time of 1 minute and the leak current less than 1mA	3000	--	--	VDC
	Input-aluminum case		1500	--	--	
	Output-aluminum case		1000	--	--	
Isolation Resistance	Input-output, insulation voltage 500VDC		1000	--	--	MΩ
Isolation Capacitance	Input-output, 100KHz/0.1V		--	2500	--	pF
Operating Temperature	See Temperature Derating Curve Fig. 1		-40	--	100	℃
Base- Plate Temperature	Within the operating temperature curve		-40	--	100	
Storage Temperature			-55	--	125	
Over-temperature Protection	Base- Plate Temperature		100	--	120	
Pin Welding Resistance Temperature	Welding spot is 1.5mm away from the casing, 10 seconds		--	--	300	
Storage Humidity	Non-condensing		5	--	95	%RH
Thermal Resistance	URF1D24HB-150W	Natural convection	7.8	--	--	℃/W
		200LFM convection	4.44	--	--	
		400LFM convection	3.39	--	--	
		1000LFM convection	2.52	--	--	
	URF1D24HB-150WH	Natural convection	3.7	--	--	
		200LFM convection	2.2	--	--	
		400LFM convection	1.76	--	--	
		1000LFM convection	1.28	--	--	
Switching Frequency	PWM mode		--	160	--	KHz
MTBF	MIL-HDBK-217F@ (Case Tb=70℃, GB)		500	--	--	K hours
Cooling Test			EN60068-2-1			
Dry Heat			EN60068-2-2			
Damp heat			EN60068-2-30			
Shock and Vibration Test			IEC/EN61373			

Physical Specifications		
Casing Material	Black flame-retardant and heat-resistant plastic (UL94-V0)	
Weight	URF1D24HB-150W	70g (Typ.)
	URF1D24HB-150WH	120g (Typ.)
Cooling method	Natural convection or Forced convection	

EMC Specifications			
EMI	CE	CISPR22/EN55022	Class B (see Fig.4)
EMS	ESD	IEC/EN61000-4-2	Contact ±6KV, Air ±8KV
		GB/T17626.2	
	RS	IEC/EN61000-4-3	10V/m
		GB/T17626.3	
			perf.Criteria B
			perf.Criteria A

EMS	CS	IEC/EN61000-4-6	10Vr.m.s	perf.Criteria A
		GB/T17626.6		
	EFT	IEC/EN61000-4-4	$\pm 2KV(5KHz/100KHz)$ (see Fig. 4 for recommended circuit)	perf.Criteria B
		GB/T17626.4		
Surge	IEC/EN61000-4-5	$\pm 2KV(1.2\mu s/50\mu s 2\Omega)$ (see Fig. 4 for recommended circuit)	perf.Criteria B	
	GB/T17626.5			
Immunities of short interruption	EN50155	100%—0%, 10ms	perf.Criteria B	

Efficiency Curves

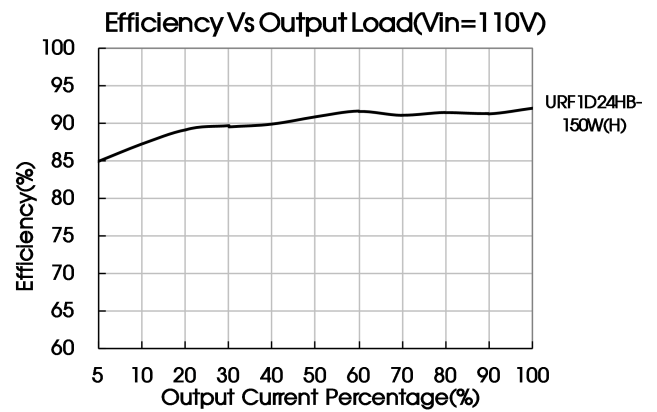
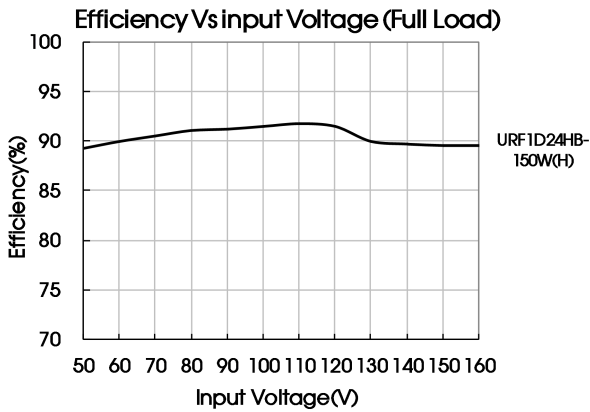

Temperature Derating Curve

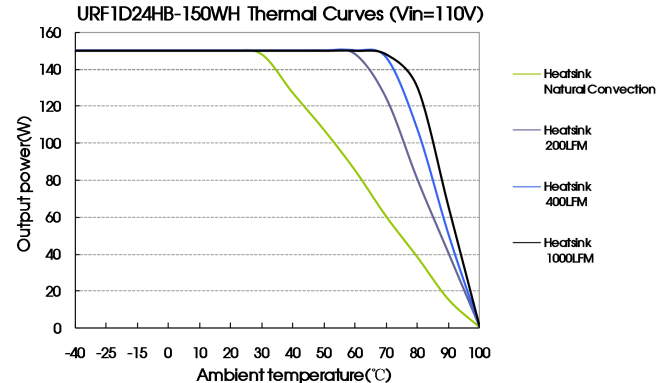
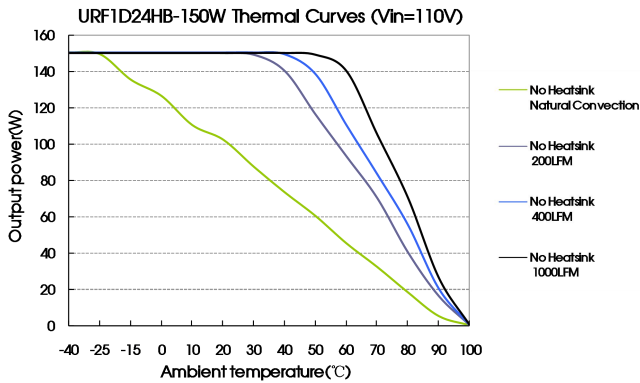
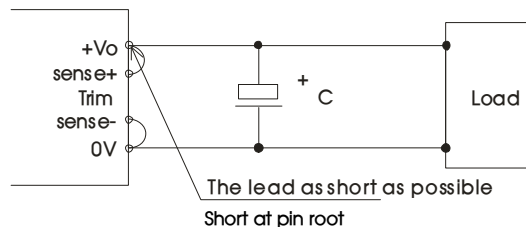

Fig. 1

Sense of application and precautions

1. When Remote Sense is not used



Notes:

1. When remote sense is not used, make sure + Vo and Sense + are shorted, and that 0V and Sense- are shorted as well;
2. Keep the patterns between + Vo and Sense + and 0V and Sense- as short as possible. Avoid a looping pattern. If noise enters the loop, the operation of the power module will become unstable.

2. When Remote Sense is used

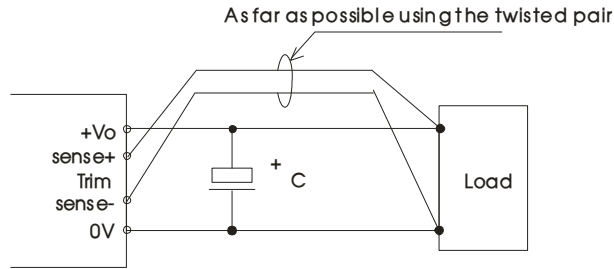

- Notes:
- Using remote sense with long wires may cause output voltage to become unstable. Consult us if long sensing wiring is necessary.
 - Sense patterns or wires should be as short as possible. If wires are used, use either twisted-pair or shielded wires.
 - Please Use wide PCB trace or a thick wires between the power supply module and the load, the line voltage drop should be kept less than 0.3V. Make sure the power supply module's output voltage remains within the specified range.
 - The impedance of wires may cause the output the voltage oscillation or have a greater ripple, please do adequate assessments before using.

Design Reference

1. Ripple & noise

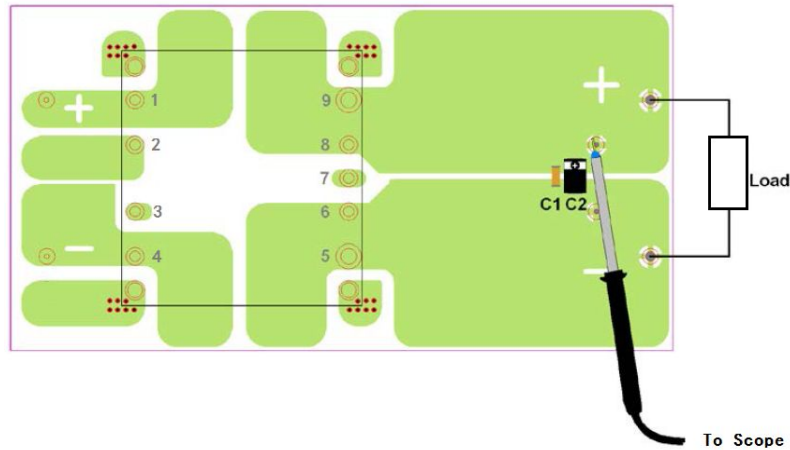

Fig. 2

Note: Capacitive value C1:1 μ F/50V; C2:10 μ F/35V.

2. Test recommended circuit

All the series' general specifications have been tested according to the following recommended test circuit before leaving the factory (see Fig. 3).

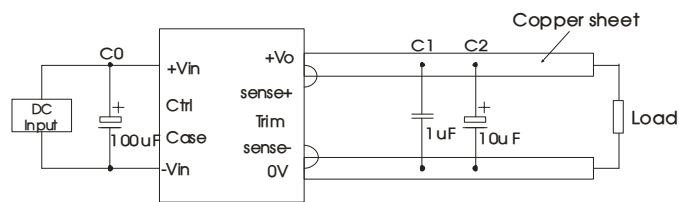

Fig. 3

3. Typical application

If it is required to further reduce input and output ripple, properly increase the input & output of additional capacitors Cin and Cout or select capacitors of low equivalent impedance provided that the capacitance is no larger than the max. capacitive load of the product.



Capacitive Parameter	Cout(μ F)	Cin(μ F)
Output Voltage		
24V	220	100

4. EMC solution-module recommended circuit

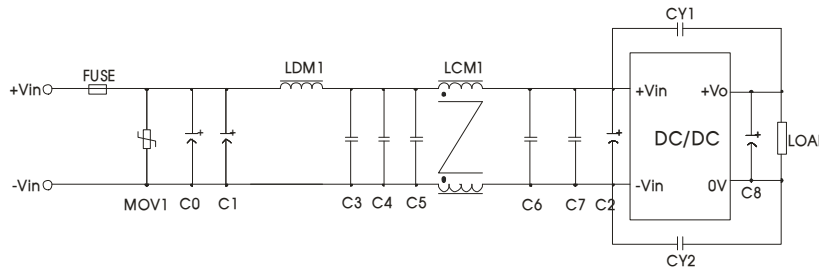
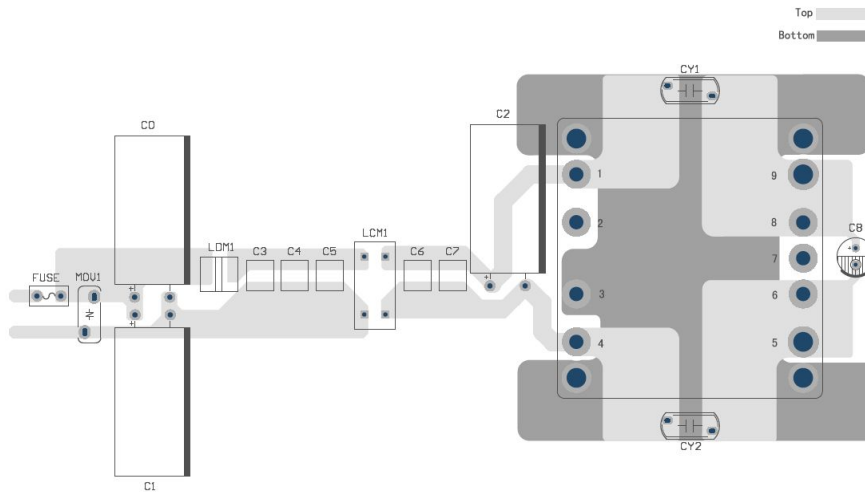

Fig. 4

Element model	Recommended value
FUSE	Choose according to actual input current
MOV1	S20K130 (Varistor)
C0	220uF/400V (electrolytic capacitor)
C1/C2	100uF/400V (electrolytic capacitor)
C3/C4/C5/C6/C7	2.2uF/250V
C8	220 uF/50V(electrolytic capacitor)
CY1	2200pF/400VAC (Y Safety capacitor)
CY2	3300pF/200VAC (Y Safety capacitor)
LDM1	10uH (Shielded inductor)
LCM1	1.0mH, recommended to use MORNSUN's FL2D-30-102

EMC solution-recommended circuit PCB layout



5. Thermal design

The maximum operating temperature of base-plate TB is 100 °C, as long as the user's thermal system keeps TB <100 °C, the converter can deliver its full rated power. A power derating curve can be calculated for any heatsink that is attached to the base-plate of the converter. It is only necessary to determine the thermal resistance, Rth(B-A), of the chosen heatsink between the base-plate and the ambient air for a given airflow rate. This information is usually available from the heatsink vendor. The following formula can be used to determine the maximum power the converter can dissipate for a given thermal condition if its base-plate is to be no higher than 100 °C.

$$P_{diss}^{max} = \frac{100^{\circ}C - T_A}{R_{th(B-A)}} \quad (T_A \text{ is ambient temperature})$$

The maximum load operating power of power supply module at a certain ambient temperature can be calculated by the power dissipation. Formula is as follows:

$$P_{O\ max} = \frac{P_{diss}^{max}}{\left(\frac{1}{\eta} - 1\right)} \quad (\eta \text{ is converter efficiency})$$

Therefore, customers can according to the actual application to choose the right heatsink.

6. Application of Trim and calculation of Trim resistance

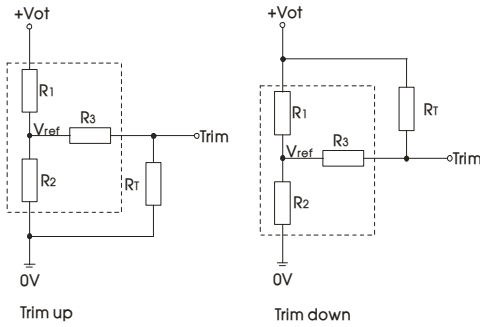

Calculation formula of Trim resistance:

$$\begin{aligned} \text{up: } R_T &= \frac{\alpha R_2}{R_2 - \alpha} - R_3 & \alpha &= \frac{V_{ref}}{V_o' - V_{ref}} \cdot R_1 \\ \text{down: } R_T &= \frac{\alpha R_1}{R_1 - \alpha} - R_3 & \alpha &= \frac{V_o' - V_{ref}}{V_{ref}} \cdot R_2 \end{aligned}$$

Note: Value for R1, R2, R3, and V_{ref} refer to the above table 1. R_T: Resistance of Trim. α: User-defined parameter, no actual meanings. V_{o'}: The trim up/down voltage.

Applied circuits of Trim (Part in broken line is the interior of models)

table 1

Parameter \ Vo	24(VDC)
R1(KΩ)	24.87
R2(KΩ)	2.87
R3(KΩ)	20
Vref(V)	2.5

7. It is not allowed to connect modules output in parallel to enlarge the power

8. For more information about Mornsun EMC Filter products, please visit www.mornsun-power.com to download the Selection Guide of EMC Filter

Dimensions and Recommended Layout (Without heatsink)

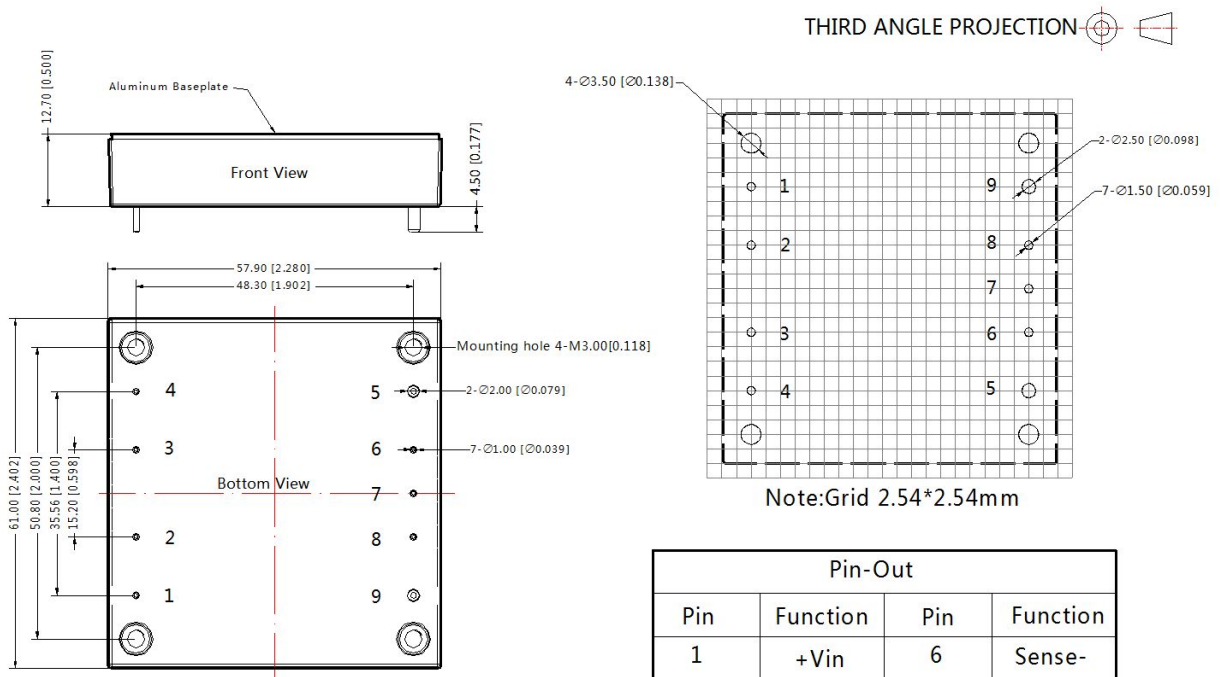

Note:
Unit:mm[inch]
Pin1,2,3,4,6,7,8's diameter:1.00[0.039]
Pin5,9's diameter:2.00[0.079]
Pin diameter tolerances:±0.10[±0.004]
General tolerances:±0.50[±0.020]
Mounting hole screwing torque: Max 0.4 N·m

Pin-Out			
Pin	Function	Pin	Function
1	+Vin	6	Sense-
2	Ctrl	7	Trim
3	Case	8	Sense+
4	-Vin	9	+Vo
5	0V		

Dimensions (With heatsink)

THIRD ANGLE PROJECTION

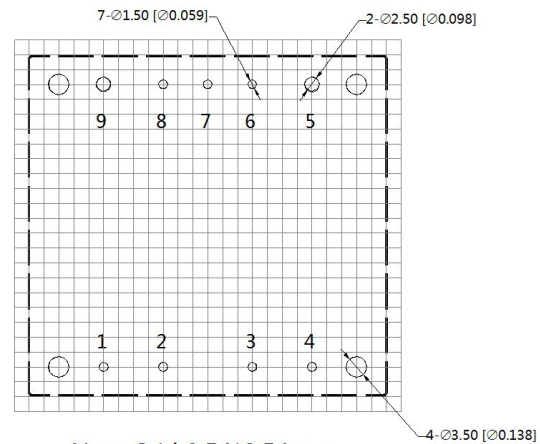
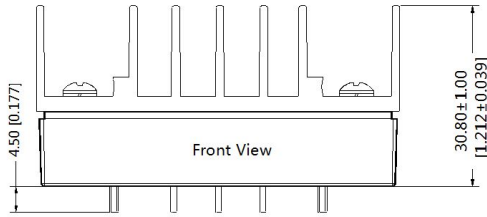

Note: Grid 2.54*2.54mm

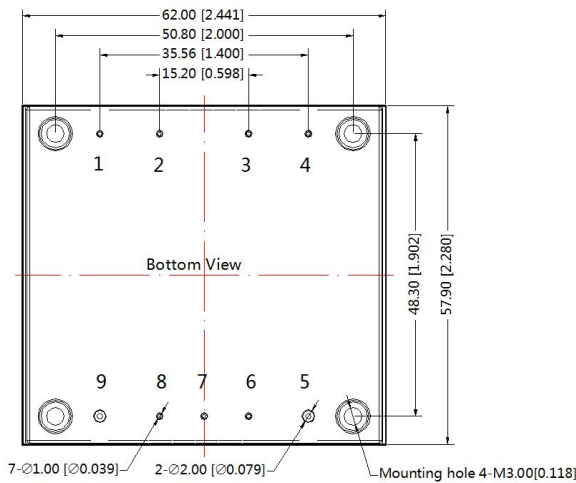

Note:
Unit:mm[inch]
Pin1,2,3,4,6,7,8's diameter:1.00[0.039]
Pin5,9's diameter:2.00[0.079]
Pin diameter tolerances:±0.10[±0.004]
General tolerances:±0.50[±0.020]
Mounting hole screwing torque: Max 0.4 N·m

Pin-Out			
Pin	Function	Pin	Function
1	+Vin	6	Sense-
2	Ctrl	7	Trim
3	Case	8	Sense+
4	-Vin	9	+Vo
5	0V		

- Note
1. Packing information please refer to Product Packing Information which can be downloaded from www.mornsun-power.com. Packing bag number:58200069(without heatsink) , 58200061(with heatsink);
 2. The max capacitive load should be tested within the input voltage range and under full load conditions;
 3. Recommends that customers plus silicone film or thermal grease between the module and the heatsink. In order to ensure good heat dissipation;
 4. Unless otherwise specified, parameters in this datasheet were measured under the conditions of Ta=25℃ , humidity<75% with nominal input voltage and rated output load;
 5. when used in lower than 10% load ,the ripple & noise index of the product is 3%Vo;
 6. All index testing methods in this datasheet are based on our Company's corporate standards;
 7. The performance parameters of the product models listed in this manual are as above, but some parameters of non-standard model products may exceed the requirements mentioned above. Please contact our technicians directly for specific information;
 8. We can provide product customization service;
 9. Specifications are subject to change without prior notice.

Mornsun Guangzhou Science & Technology Co., Ltd.

Address: No. 5, Kehui St. 1, Kehui Development Center, Science Ave., Guangzhou Science City, Luogang District, Guangzhou, P. R. China
Tel: 86-20-38601850-8801 Fax: 86-20-38601272 E-mail: info@mornsun.cn