

GEM_035, 049 QUAD SCR MODULES

Preliminary Data Sheet

- ▶ Electrically insulated metal frame
- ▶ Extremely high power density
- ▶ 3000 V_{RMS} insulation voltage
- ▶ Line voltage range up to 230 V_{RMS}
- ▶ High reliability
- ▶ Modularity
- ▶ Fully customizable
- ▶ Broad range of accessories
- ▶ Cost effective solution
- ▶ Suitable for heavy duty applications

Description

This new family of high power modules brings to the high power applications the same compactness, ease of use and scalability of the lower power semiconductor modules. In addition to these typical features (i.e. standard dimensions, electrical insulation, various circuit types, etc.) the new Green Power Easy Module (GEM) family includes many features aimed to simplify their adoption allowing the end users to focus on their core business. These features include:

- embedded air cooling system (heatsink and fan)
- optimised snubber circuits
- pulse transformer modules
- ducted heat flow.

Maximum Ratings

Part number	GEM_043	GEM_049	GEM_035			Conditions	Units
$I_{T(AV)}$	431	497	356			180° cond, half sine T _a = 40 °C Air velocity = 5 m/s	A
$I_{T(RMS)}$	677	780	559				A
I_{TSM}	12.8	30	22			50 Hz, T _j = T _{jmax} , V _R = 0 V	kA
I_{TSM}	13.5	31.7	23.2			60 Hz, T _j = T _{jmax} , V _R = 0 V	kA
I^2t	819	4500	2420			50 Hz, T _j = T _{jmax} , V _R = 0 V	kA ² s
I^2t	745	4095	2202			60 Hz, T _j = T _{jmax} , V _R = 0 V	kA ² s
V _{DRM} /V _{RPM}	400	800	1000			T _j = T _{jmax}	V
T _{jmax}	150	150	125				°C

Part Number	V code	V _{DRM} V _{VRRM} max repetitive reverse and off-state blocking voltage [V]	I _{DRM} I _{RRM} @ T _{jmax} [mA]	V _{L(RMS)} maximum suggested RMS line voltage [V]
GEM_043	04	400	50	115
GEM_049	08	800	100	190
GEM_035	10	1000	75	230

On-State Characteristics

Parameters	GEM_043	GEM_049	GEM_035			Conditions	Units
V _{T(TO)} Threshold voltage	0.87	0.80	0.85			T _j = T _{jmax}	V
r _T On-state slope resistance	0.238	0.170	0.270			T _j = T _{jmax}	mΩ
I _H Holding current, max	600	300	300			T _j = 25°C	mA
I _L Latching current, typ	1000	1000	1000			T _j = 25°C	mA
P _{MAX} Max power losses	970	1006	777			T _A = 40°C	W

Triggering Characteristics

Parameters	GEM_043	GEM_049	GEM_035			Conditions	Units
V _{GT} Gate trigger voltage	2.5	2.5	2.5			T _j = 25°C, V _D = 5V	V
I _{GT} Gate trigger current	190	250	250			T _j = 25°C, V _D = 5V	mA
P _{GM} Peak gate power dissipation	10	15	15			Pulse width 1 ms	W
P _{G(AV)} Average gate power dissipation	2	4	4				W
I _{FGM} Peak gate current	3	8	8				A
V _{FGM} Peak gate voltage (forward)	20	20	20				V
V _{RGM} Peak gate voltage (reverse)	5	5	5				V

Switching Characteristics

Parameters	GEM_043	GEM_049	GEM_035			Conditions	Units
di/dt Critical rate of rise of on-state current	200	400	400			T _j = T _{jmax}	A/μs
dV/dt Critical rate of rise of off-state voltage	500	1000	1000			T _j = T _{jmax}	V/μs
t _q Turn-off time, typ	200	200	200			T _j =T _{jmax} , I _T =1000A di/dt=-20A/μs V _R =50V dV/dt=20V/μs	μs

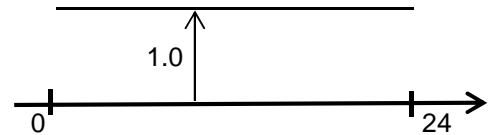

Maximum IEC class 1 currents for typical circuit type

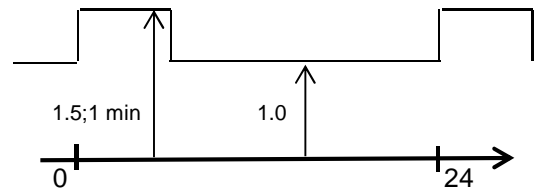
Circuit Type	GEM_043	GEM_049	GEM_035			Conditions	Units
AC switch	963	1111	796			T _A = 40 °C delay angle = 0°	A
Center tap	862	995	713			T _A = 40 °C delay angle = 0°	A
Two pulse bridge	862	995	713			T _A = 40 °C delay angle = 0°	A
Six pulse bridge	1244	1440	1030			T _A = 40 °C delay angle = 0°	A
Double star with I.P. transf.	2495	2887	2066			T _A = 40 °C delay angle = 0°	A

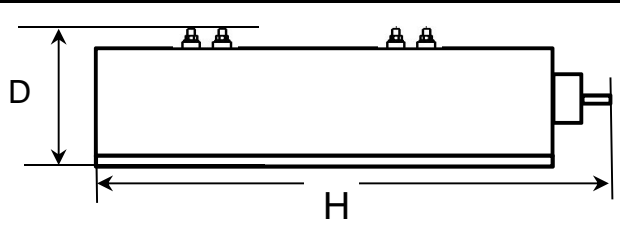

Maximum IEC class 2 currents for typical circuit type

Circuit Type	GEM_043	GEM_049	GEM_035			Conditions	Units
AC switch	777	888	644			T _A = 40 °C delay angle = 0°	A
Center tap	700	800	580			T _A = 40 °C delay angle = 0°	A
Two pulse bridge	700	800	580			T _A = 40 °C delay angle = 0°	A
Six pulse bridge	1000	1160	840			T _A = 40 °C delay angle = 0°	A
Double star with I.P. transf.	2000	2360	1690			T _A = 40 °C delay angle = 0°	A

Thermal and mechanical characteristics

Parameters	GEM_043	GEM_049	GEM_035			Conditions	Units
T _{jmax} Max operating junction temperature	150	150	125				°C
T _{stg} Storage temperature	-40 +70	-40 +70	-40 +70				°C
R _{thJA} Thermal resistance (junction to ambient)	0.227	0.219	0.219			Air velocity = 5 m/s	°C/W
F Mounting torque - GEM to panel (+/- 10%) Mounting torque - busbar to GEM (+/- 10%)	7	7	7			M6 mounting screw	N·m
	14	14	14			M8 mounting screw	N·m
m Mass, typ						with FAPC options	kg
Overall dimensions							
D Depth	200						mm
H Height	570					mm	
W Width	103					mm	

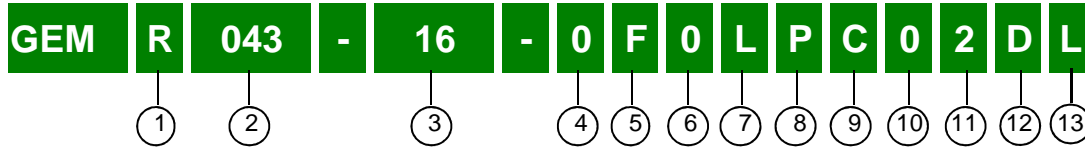
PART-NUMBERING SYSTEM



- ① Circuit configuration
- ② GEM average current / 10
- ③ GEM blocking voltage / 100
- ④ 0 = No fan
- ⑤ 0 = No fuse - F = With fuse protection
- ⑥ 0 = No standard busbar available for this module; please contact factory in case of specific need
- ⑦ 0 = No anti-parallel busbar - L = Anti-parallel busbar
- ⑧ 0 = No pulse transformer - P = With pulse transformer *
- ⑨ 0 = No fan loss detection module - C = With fan loss detection module
- ⑩ 0 = No SCR fault detection module - S = SCR fault detection module (for AC-switch circuits)
- ⑪ 0 = No snubber - 1 = One snubber - 2 = Two snubbers
- ⑫ 0 = No fan-on-demand thermo-switch - D = Fan-on-demand thermo-switch (trip point 50 °C)
- ⑬ 0 = No current transformer - L (R) = Sirio current transformer on the Left side (or on the Right side)

* Pulse transformer GT001 (dual) or GT002 (single) depending on the circuit configuration.
For pulse transformer characteristics see their specific datasheets.

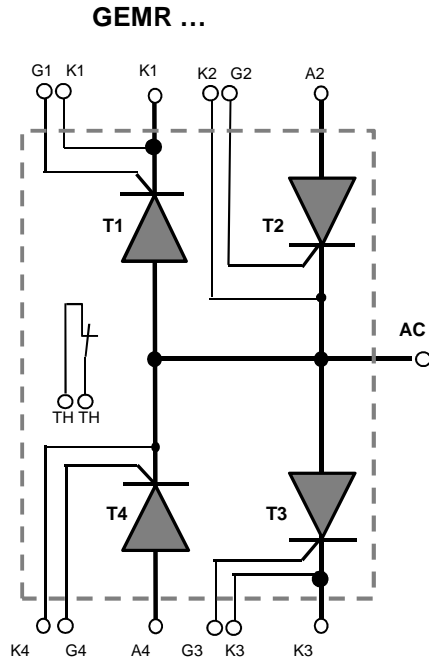

Example of application - 3P Regen bridge realized with three GEMR modules

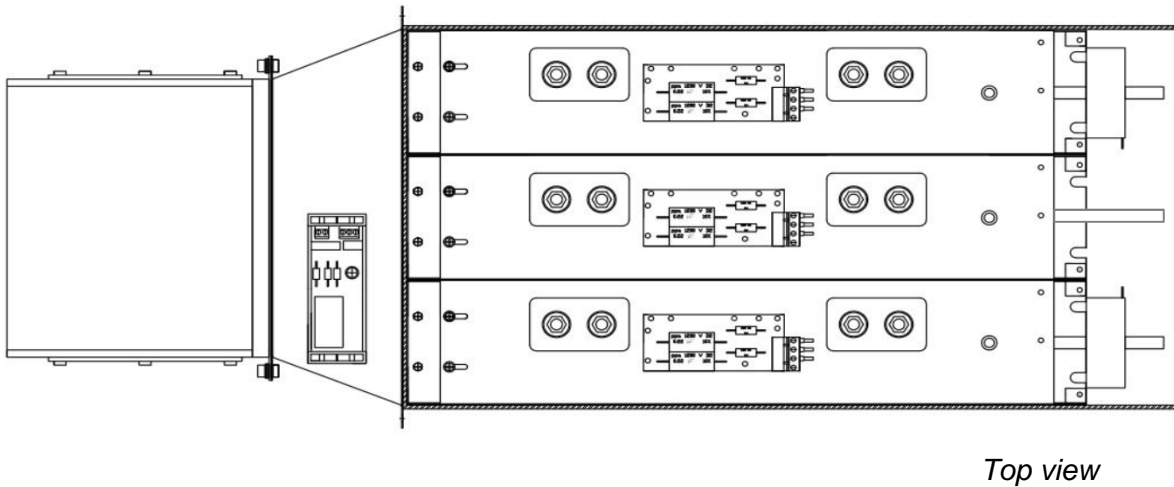
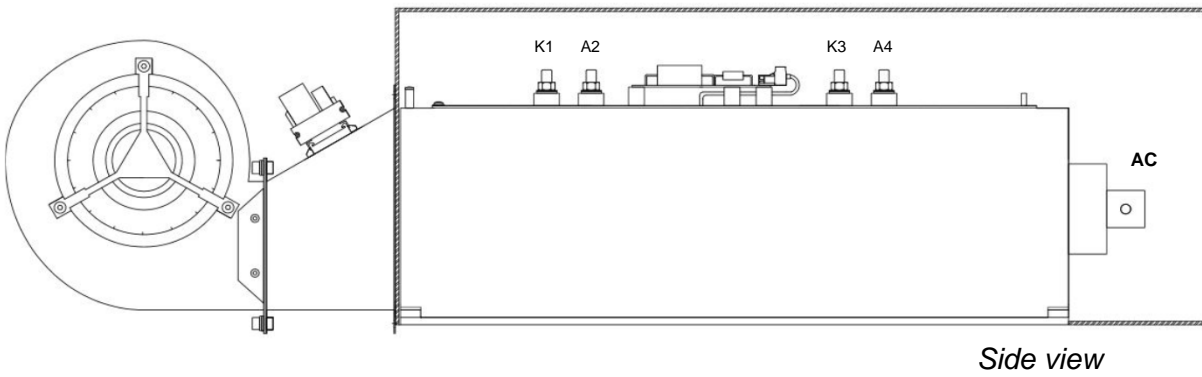

In the interest of product improvement Green Power Solutions reserves the right to change any specification given in this data sheet without notice.