

THIS DRAWING IS UNPUBLISHED.

RELEASED FOR PUBLICATION

20

© COPYRIGHT 20 BY -

ALL RIGHTS RESERVED.

LOC	DIST
-	-

REVISIONS					
P	LTR	DESCRIPTION	DATE	DWN	APVD
	D	RELEASED AS PER ECR-11-012557	17JUN2011	MZ	GT
	D1	PARTS -2 -3 1-2 and 1-3 RELEASED FOR PRODUCTION	27JUN2013	KR	JC
	E	UPDATED DRAWING	19DEC2014	KR	MZ

NOTES:

- 1 MATERIAL: POLYAMIDE GLASS FILLED COLOUR NATURAL
- 2 MATERIAL: POLYAMIDE GLASS FILLED COLOUR BLACK
- 3) PACKAGING: SEE TE PACKAGING SPECIFICATION 107-20294
- 4 TE LOGO
- 5 N CODE
- 6 L CODE
- 7 PE CODE
- 8 RATED VOLTAGE
- 9 WIRE SIZE & RATED CURRENT
- 10 AREA FOR AGENCY APPROVAL LOGO
- 11 IP CODE
- 12) SOCKET CAP P/N 293596-1 (SEE DRAWING 293596 FOR REFERENCE) HAS TO BE ASSEMBLED TO GUARANTEE IP40 DEGREE OF PROTECTION WHEN CONNECTOR HOUSING IS NOT MATTED WITH COUNTERPART
- 13 NOT YET RELEASED FOR PRODUCTION
- 14 DATA CODE

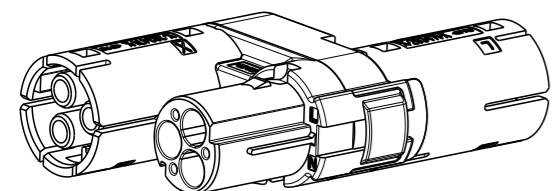
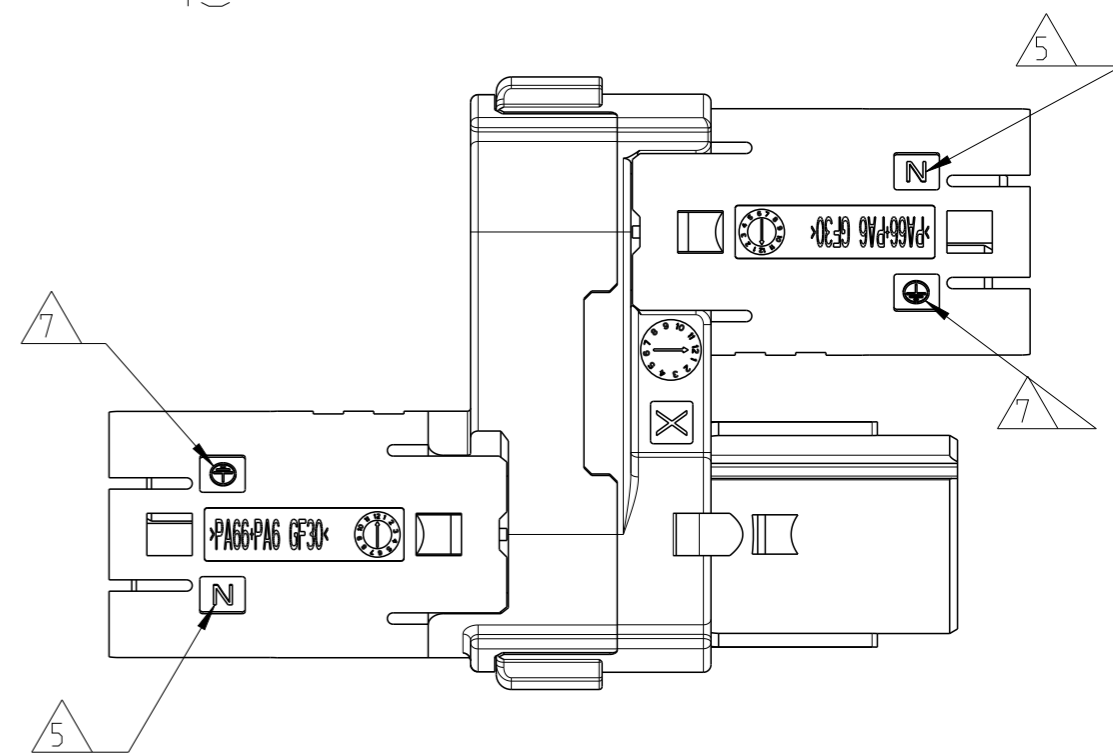
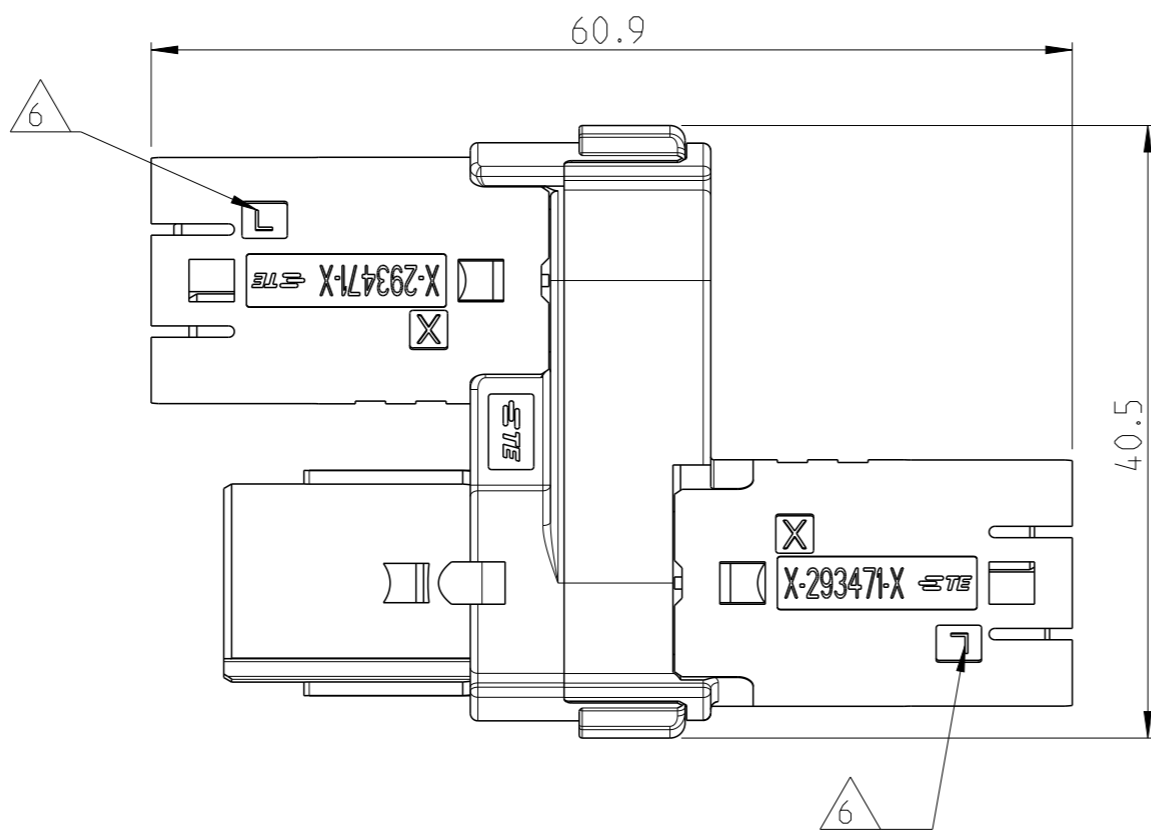
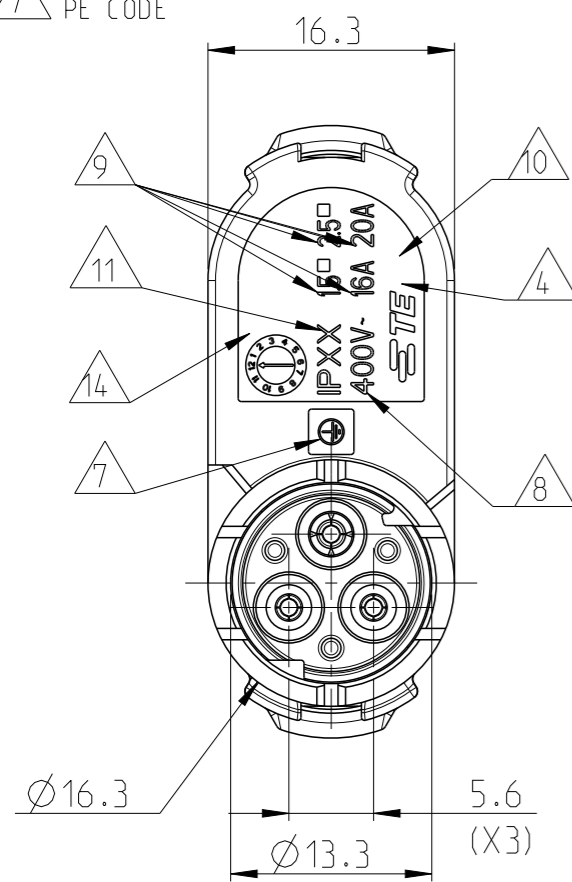
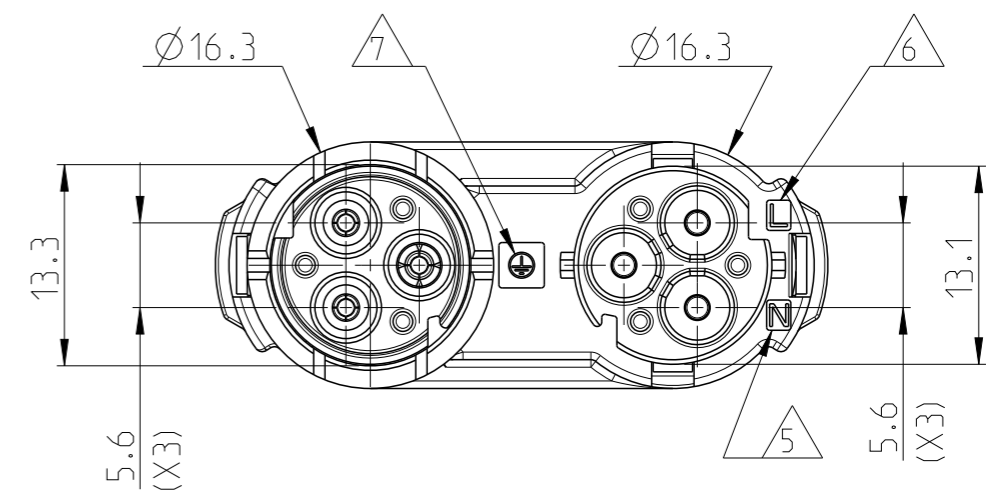

SCALE 1:1

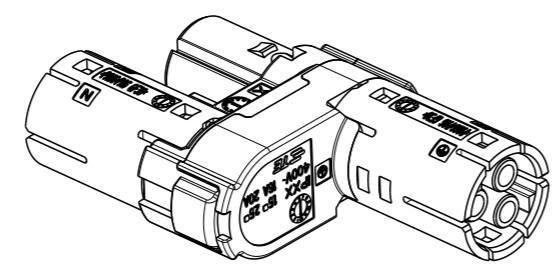

THIS DRAWING IS A CONTROLLED DOCUMENT.

DIMENSIONS:	TOLERANCES UNLESS OTHERWISE SPECIFIED:
mm	
	0 PLC ±
	1 PLC ±0.3
	2 PLC ±0.20
	3 PLC ±
	4 PLC ±
	ANGLES ±3°
MATERIAL	FINISH
-	-

DWN	M. ZUCCA	06OCT2009
CHK	U. AIME	06OCT2009
APVD	G. TURCO	06OCT2009
PRODUCT SPEC	-	-
APPLICATION SPEC	-	-
WEIGHT	-	-

STE TE Connectivity			
NAME T-SPLITTER CONNECTOR* M-LINE 3 POLES UNSEALED VERSION			
SIZE	CAGE CODE	DRAWING NO	RESTRICTED TO
A3	00779	C-293611	-

Customer Drawing	SCALE 2:1	SHEET 1 OF 2	REV E
------------------	-----------	--------------	-------

THIS DRAWING IS UNPUBLISHED.

RELEASED FOR PUBLICATION

20









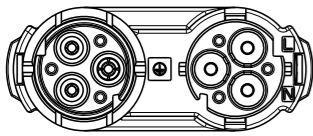
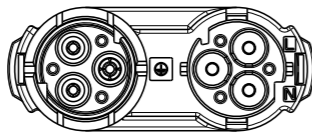
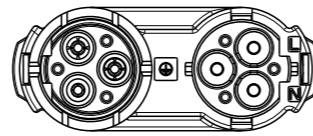
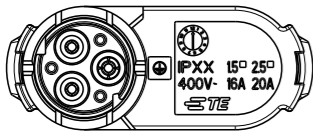
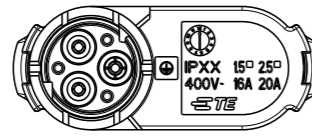
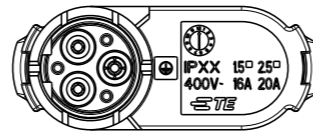
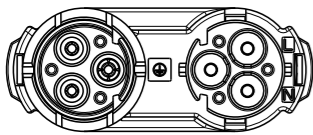
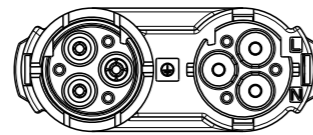
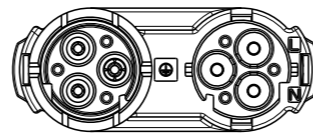
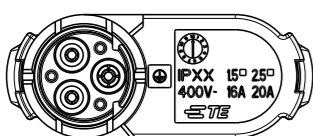
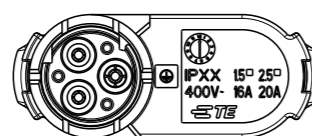
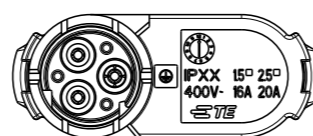

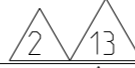
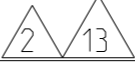
© COPYRIGHT 20 BY -

ALL RIGHTS RESERVED.

LOC	DIST	REVISIONS					
		P	LTR	DESCRIPTION	DATE	DWN	APVD
-	-	-	-	SEE SHEET 1	-	-	-

POLARIZATION TYPES SCALE 1:1

TYPE "A"	TYPE "B"	TYPE "C"
		
		
P/Ns: 293611-1, 1-293611-1	P/Ns: 293611-2, 1-293611-2	P/Ns: 293611-3, 1-293611-3
TYPE "D"	TYPE "E"	TYPE "F"
		
		
P/Ns: 293611-4, 1-293611-4	P/Ns: 293611-5, 1-293611-5	P/Ns: 293611-6, 1-293611-6

	UNSEALED	F	BLACK	T-SPLITTER CONNECTOR NECTOR* M-LINE	D	1-293611-6
	UNSEALED	E	BLACK	T-SPLITTER CONNECTOR NECTOR* M-LINE	D	1-293611-5
	UNSEALED	D	BLACK	T-SPLITTER CONNECTOR NECTOR* M-LINE	D	1-293611-4
	UNSEALED	C	BLACK	T-SPLITTER CONNECTOR NECTOR* M-LINE	E	1-293611-3
	UNSEALED	B	BLACK	T-SPLITTER CONNECTOR NECTOR* M-LINE	E	1-293611-2
	UNSEALED	A	BLACK	T-SPLITTER CONNECTOR NECTOR* M-LINE	E	1-293611-1
	UNSEALED	F	NATURAL	T-SPLITTER CONNECTOR NECTOR* M-LINE	D	293611-6
	UNSEALED	E	NATURAL	T-SPLITTER CONNECTOR NECTOR* M-LINE	D	293611-5
	UNSEALED	D	NATURAL	T-SPLITTER CONNECTOR NECTOR* M-LINE	D	293611-4
	UNSEALED	C	NATURAL	T-SPLITTER CONNECTOR NECTOR* M-LINE	E	293611-3
	UNSEALED	B	NATURAL	T-SPLITTER CONNECTOR NECTOR* M-LINE	E	293611-2
	UNSEALED	A	NATURAL	T-SPLITTER CONNECTOR NECTOR* M-LINE	E	293611-1
NOTE	VERSION	POL. KEYING	COLOUR	DESCRIPTION	REV.	PART NUMBER

THIS DRAWING IS A CONTROLLED DOCUMENT.

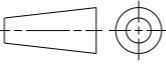
DIMENSIONS:	TOLERANCES UNLESS OTHERWISE SPECIFIED:
mm	
	0 PLC ±
	1 PLC ±0.3
	2 PLC ±0.20
	3 PLC ±
	4 PLC ±
	ANGLES ±3°
MATERIAL -	FINISH -

DWN	M. ZUCCA	06OCT2009
CHK	U. AIME	06OCT2009
APVD	G. TURCO	06OCT2009
PRODUCT SPEC	-	-
APPLICATION SPEC	-	-
WEIGHT	-	-

 TE Connectivity			
NAME T-SPLITTER CONNECTOR NECTOR* M-LINE 3 POLES UNSEALED VERSION			
SIZE	CAGE CODE	DRAWING NO	RESTRICTED TO
A3	00779	©=293611	-

Customer Drawing SCALE 1:1 SHEET 2 OF 2 REV E