

SMD Power Inductor CDR7D28MN

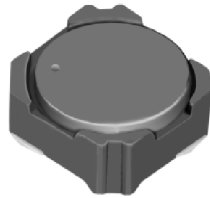

Description

- Ferrite drum core construction.
- Magnetically shielded.
- L × W × H: 7.6 × 7.6 × 3.0 mm Max.
- Product weight: 0.46g(Ref.)
- Moisture Sensitivity Level: 1
- RoHS compliance.

Environmental Data

- Operating temperature range: -40°C~+105°C (including coil's self temperature rise)
- Storage temperature range: -40°C~+105°C
- Solder reflow temperature: 260 °C peak.

Packaging

- Carrier tape and reel packaging
- 12.9" diameter reel
- 1000pcs per reel

Applications

- Ideally used in LCD driver, DSC/DVC , Notebook PC or the other portable equipment

Dimension - [mm]

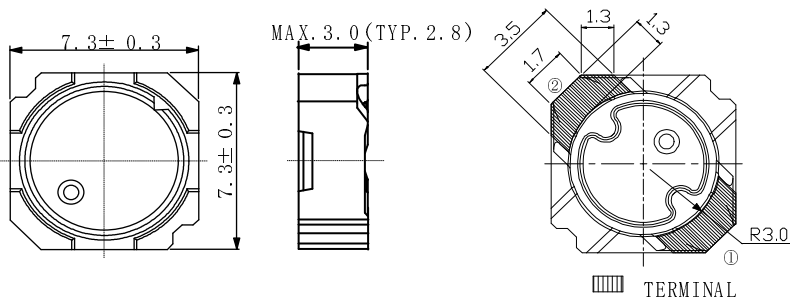

Land pattern and Schematics - [mm]

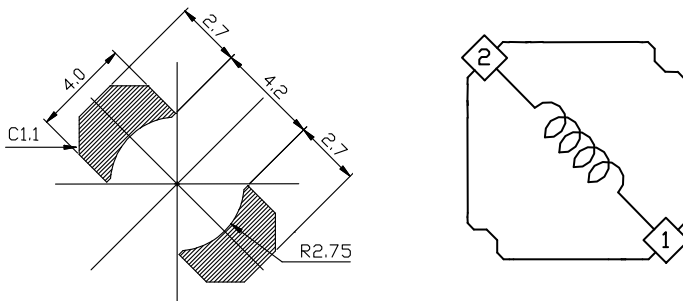

SMD Power Inductor CDR7D28MN



Electrical Characteristics

| Part Name | Stamp | Inductance (μ H) [Within] ※1 | D.C.R. (m Ω) Max. (Typ.) (at 20°C) | Saturation Current (A) ※2 | | Temperature rise current: (A) ※3 |
|--------------------|-------|---|--|------------------------------|------------|--|
| | | | | (at 20°C) | (at 105°C) | |
| CDR7D28MNNP-1R2 NC | 1R2 | 1.2 μ H \pm 25% | 20.5(16.4) | 5.90 | 4.65 | 4.50 |
| CDR7D28MNNP-2R0 NC | 2R0 | 2.0 μ H \pm 25% | 23.8(19) | 4.55 | 3.65 | 3.95 |
| CDR7D28MNNP-2R7 NC | 2R7 | 2.7 μ H \pm 25% | 27.5(22) | 4.10 | 3.30 | 3.70 |
| CDR7D28MNNP-3R6 NC | 3R6 | 3.6 μ H \pm 25% | 32.5(26) | 3.55 | 2.90 | 3.45 |
| CDR7D28MNNP-4R6 NC | 4R6 | 4.6 μ H \pm 25% | 37.5(30) | 3.30 | 2.65 | 3.20 |
| CDR7D28MNNP-6R8 NC | 6R8 | 6.8 μ H \pm 25% | 46.3(37) | 2.90 | 2.45 | 2.75 |
| CDR7D28MNNP-8R0 NC | 8R0 | 8.0 μ H \pm 25% | 50.0(40) | 2.60 | 2.10 | 2.60 |
| CDR7D28MNNP-100 NC | 100 | 10 μ H \pm 25% | 53.8(48) | 2.40 | 1.95 | 2.50 |
| CDR7D28MNNP-150 NC | 150 | 15 μ H \pm 25% | 81.3(65) | 2.10 | 1.65 | 2.00 |
| CDR7D28MNNP-220 NC | 220 | 22 μ H \pm 25% | 120.0(96) | 1.65 | 1.35 | 1.60 |
| CDR7D28MNNP-330 NC | 330 | 33 μ H \pm 25% | 196.3(157) | 1.35 | 1.10 | 1.20 |
| CDR7D28MNNP-470 NC | 470 | 47 μ H \pm 25% | 275.0(220) | 1.05 | 0.85 | 1.00 |
| CDR7D28MNNP-680 NC | 680 | 68 μ H \pm 25% | 425.0(340) | 0.90 | 0.70 | 0.78 |
| CDR7D28MNNP-101 NC | 101 | 100 μ H \pm 25% | 655.0(524) | 0.75 | 0.60 | 0.65 |
| CDR7D28MNNP-151 NC | 151 | 150 μ H \pm 25% | 950.0(760) | 0.60 | 0.45 | 0.52 |
| CDR7D28MNNP-221 NC | 221 | 220 μ H \pm 25% | 1320(1100) | 0.50 | 0.40 | 0.40 |
| CDR7D28MNNP-331 NC | 331 | 330 μ H \pm 25% | 2184(1820) | 0.35 | 0.30 | 0.31 |
| CDR7D28MNNP-471 NC | 471 | 470 μ H \pm 25% | 2652(2210) | 0.30 | 0.25 | 0.28 |

※1. Inductance measuring condition: at 100kHz.

※2. Saturation current: The value of D.C. current when the inductance decreases to 65% of its nominal value.

※3. Temperature rise current: The value of D.C. current when the temperature rise is $\Delta t = 40^\circ\text{C}$ ($T_a = 20^\circ\text{C}$).

SMD Power Inductor CDR7D28MN



Saturation Current & Temperature Rise Graph

— L (20°C) — L (100°C) — ΔT

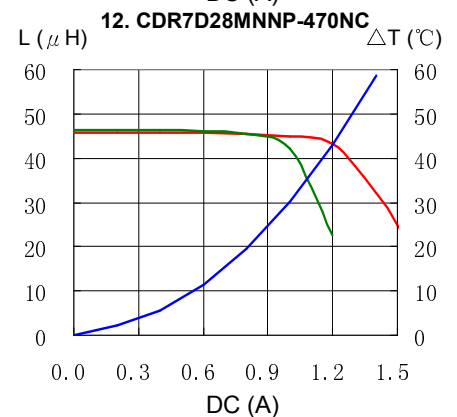
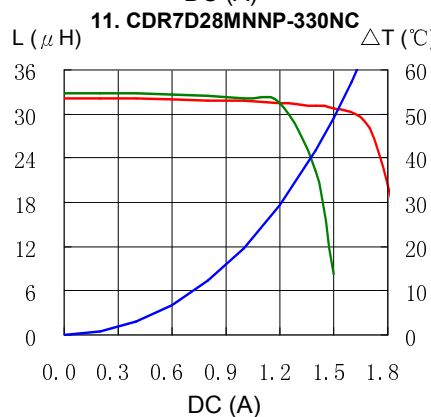
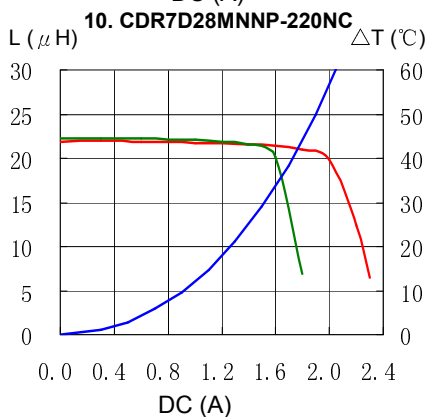
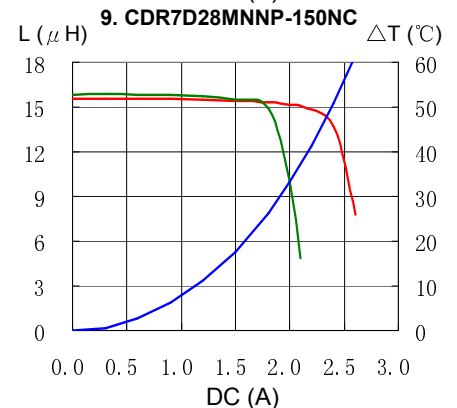
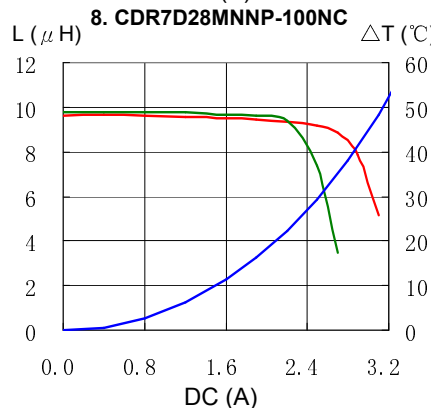
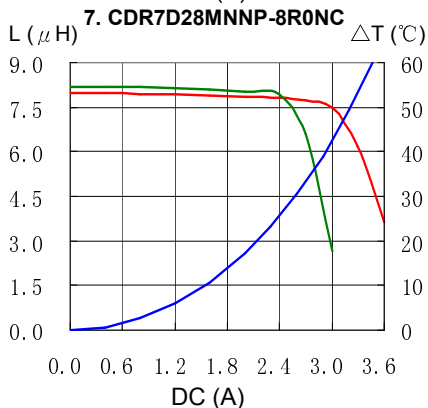
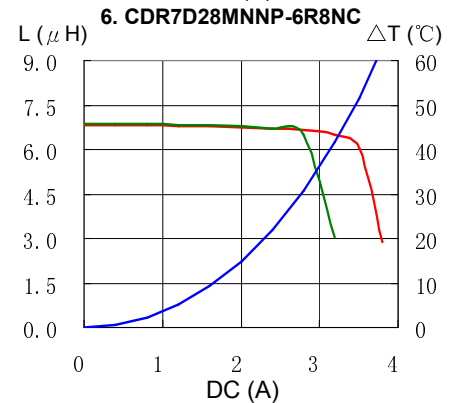
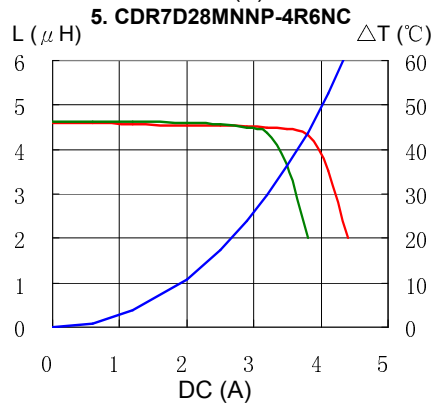
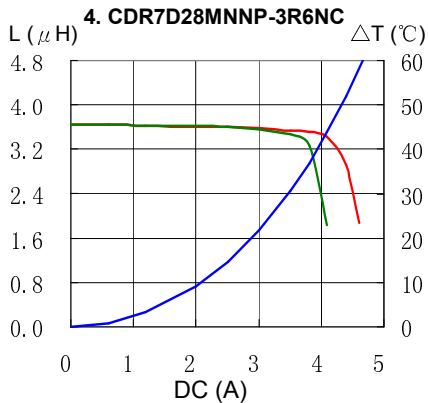
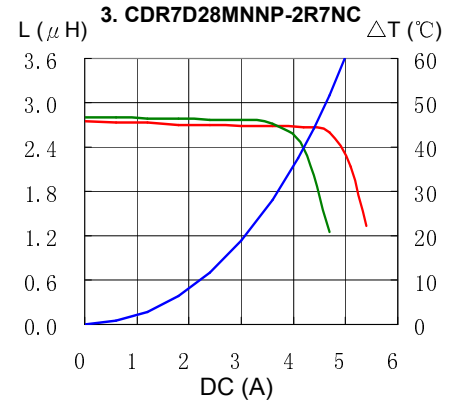
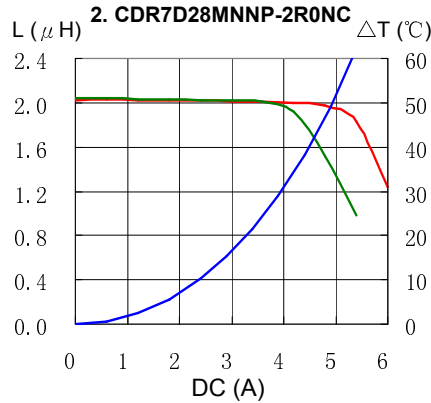
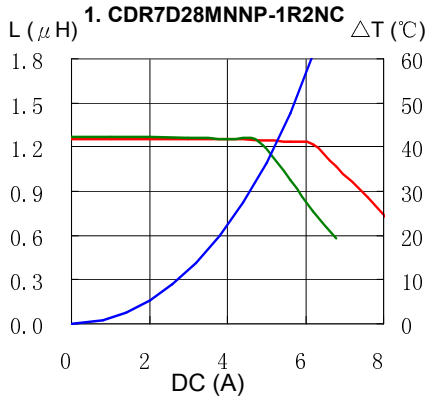

SMD Power Inductor CDR7D28MN



Saturation Current & Temperature Rise Graph

— L (20°C) — L (100°C) — ΔT

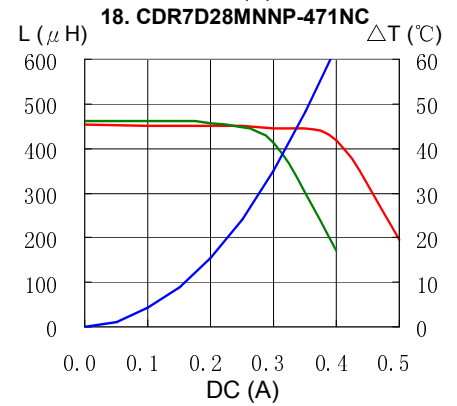
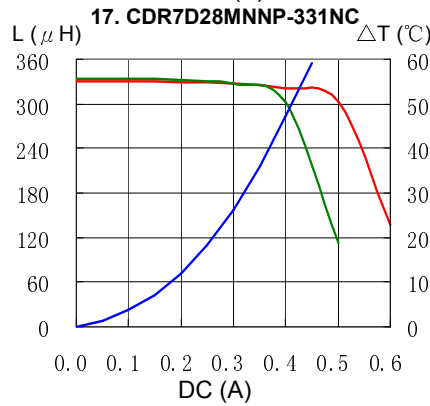
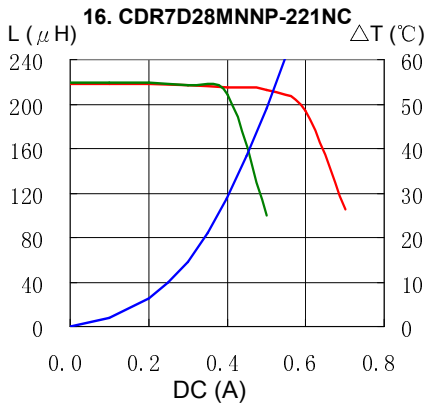
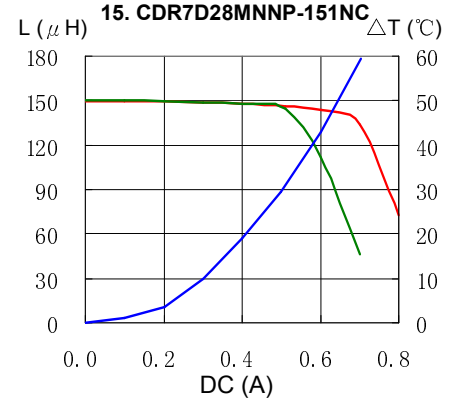
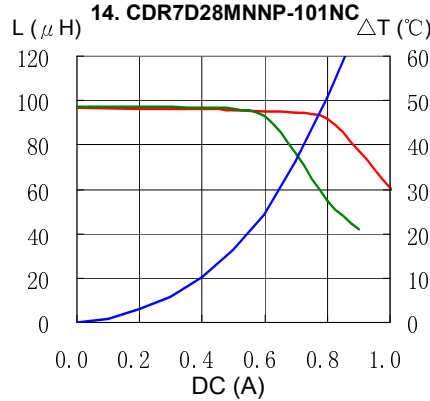
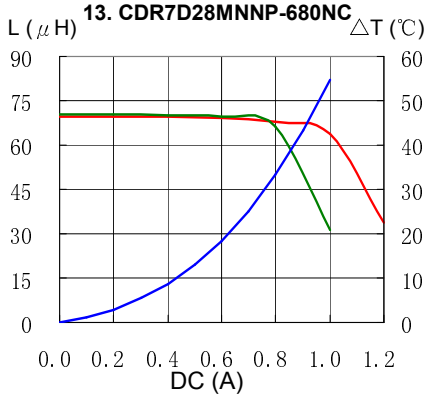

Solder Reflow Condition

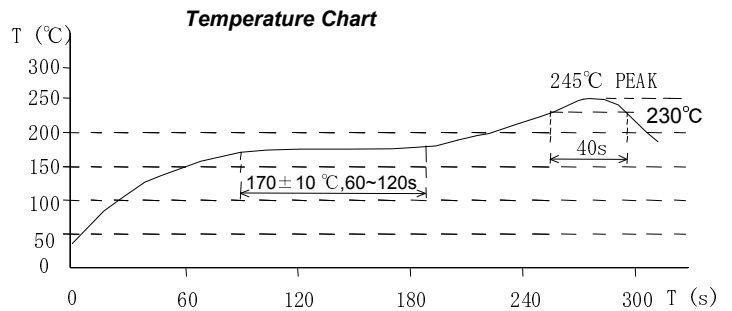
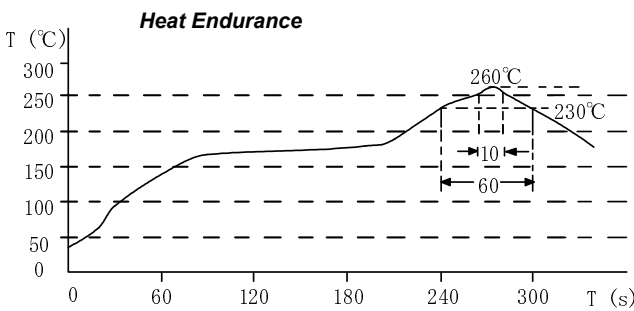

Please refer to the sales offices on our website - <http://www.sumida.com>

Hong Kong
Tel.+852-2880-6781
FAX.+852-2565-9600
sales@hk.sumida.com

Saitama(Japan)
Tel.+81-48-691-7300
FAX.+81-48-691-7340
sales@jp.sumida.com

Chicago
Tel.+1-847-545-6700
FAX. +1-847-545-6720
sales@us.sumida.com

Shanghai
Tel.+86-21-5836-3299
FAX.+86-21-5836-3266
shanghai.sales@cn.sumida.com

Seoul
Tel.+82-2-6237-0777
FAX.+82-2-6237-0778
sales@kr.sumida.com

Oberzell
Tel.+49-8591-937-0
FAX. +49-8591-937-103
contact@eu.sumida.com

Shenzhen
Tel.+86-755-8291-0228
FAX.+86-755-8291-0338
shenzhen.sales@cn.sumida.com

Singapore
Tel.+65-6296-3388
FAX.+65-6841-4426
sales@sg.sumida.com

Neumarkt
Tel.+49-9181-4509-110
FAX. +49-9181-4509-310
infocomp@eu.sumida.com

Taipei
Tel.+886-2-8751-2737
FAX.+886-2-8751-2738
sales@tw.sumida.com

San Jose
Tel.+1-408-321-9660
FAX.+1-408-321-9308
sales@us.sumida.com