

## 1. Overview

### 1.1 Features

The R8C/M13B Group of single-chip microcontrollers (MCUs) incorporates the R8C CPU core, which provides sophisticated instructions for a high level of efficiency. With 1 Mbyte of address space, the CPU core is capable of executing instructions at high speed. In addition, it features a multiplier for high-speed arithmetic processing.

Power consumption is low, and the supported operating modes allow additional power control. These MCUs are designed to maximize EMI/EMS performance.

Integration of many peripheral functions on the same chip, including multifunction timer and serial interface, reduces the number of system components.

The R8C/M13B Group includes data flash (1 KB × 2 blocks).

#### 1.1.1 Applications

Home appliances, office equipment, audio equipment, consumer products, etc.

## 1.1.2 Specifications

Tables 1.1 and 1.2 outline the Specifications.

**Table 1.1 Specifications (1)**

Item	Function	Description
CPU	Central processing unit	R8C CPU core <ul style="list-style-type: none"> <li>• Number of fundamental instructions: 89</li> <li>• Minimum instruction execution time:               <ul style="list-style-type: none"> <li>50 ns (<math>f(XIN) = 20</math> MHz, <math>VCC = 2.7</math> V to 5.5 V)</li> <li>200 ns (<math>f(XIN) = 5</math> MHz, <math>VCC = 1.8</math> V to 5.5 V)</li> </ul> </li> <li>• Multiplier: 16 bits <math>\times</math> 16 bits <math>\rightarrow</math> 32 bits</li> <li>• Multiply-accumulate instruction: 16 bits <math>\times</math> 16 bits + 32 bits <math>\rightarrow</math> 32 bits</li> <li>• Operating mode: Single-chip mode (address space: 1 Mbyte)</li> </ul>
Memory	ROM, RAM, data flash	See <b>Table 1.3 Product List</b> .
Reset sources		<ul style="list-style-type: none"> <li>• Hardware reset by <math>\overline{RESET}</math></li> <li>• Power-on reset</li> <li>• Watchdog timer reset</li> <li>• Software reset</li> <li>• Reset by voltage detection 0</li> </ul>
Voltage detection	Voltage detection circuit	Voltage detection with two check points: Voltage detection 0, voltage detection 1 (detection levels selectable)
Watchdog timer		<ul style="list-style-type: none"> <li>• 14 bits <math>\times</math> 1 (with prescaler)</li> <li>• Reset start function selectable</li> <li>• Count source protection function selectable</li> <li>• Periodic timer function selectable</li> </ul>
Clock	Clock generation circuits	<ul style="list-style-type: none"> <li>• 4 circuits: XIN clock oscillation circuit, XCIN clock oscillation circuit, high-speed on-chip oscillator (with frequency adjustment function), low-speed on-chip oscillator</li> <li>• Oscillation stop detection: XIN clock oscillation stop detection function</li> <li>• Clock frequency divider circuit integrated</li> </ul>
Power control		<ul style="list-style-type: none"> <li>• Standard operating mode</li> <li>• Wait mode (CPU stopped, peripheral functions in operation)</li> <li>• Stop mode (CPU and peripheral functions stopped)</li> </ul>
Interrupts		<ul style="list-style-type: none"> <li>• Number of interrupt vectors: 69</li> <li>• External interrupt inputs: 8 (<math>\overline{INT} \times 4</math>, key input <math>\times 4</math>)</li> <li>• Priority levels: 2</li> </ul>
I/O ports	Programmable I/O ports	<ul style="list-style-type: none"> <li>• CMOS I/O: 29 (pull-up resistor selectable)</li> <li>• High-current drive ports: 8</li> </ul>
Timer	Timer RJ2	16 bits $\times$ 1 Timer mode, pulse output mode (output level inverted every period), event counter mode, pulse width measurement mode, pulse period measurement mode
	Timer RB2	8 bits $\times$ 1 (with 8-bit prescaler) or 16 bits $\times$ 1 (selectable) Timer mode, programmable waveform generation mode (PWM output), programmable one-shot generation mode, programmable wait one-shot generation mode
	Timer RC	16 bits $\times$ 1 (with 4 capture/compare registers) Timer mode (output compare function, input capture function), PWM mode (3 outputs), PWM2 mode (1 PWM output)
	Timer RK	8 bits $\times$ 1 Interval mode, pulse output mode, output compare mode
	Timer RE2	8 bits $\times$ 1 Real-time clock mode, compare match timer mode
Serial interface	UART0	Clock synchronous serial I/O. Also used for asynchronous serial I/O.
	UART1	
Clock synchronous serial interface		<ul style="list-style-type: none"> <li>• Synchronous serial communication unit (SSU) <math>\times</math> 1 channel</li> <li>• I<sup>2</sup>C bus interface <math>\times</math> 1 channel</li> </ul>

**Table 1.2 Specifications (2)**

Item	Function	Description
IrDA interface		1 channel (UART0 and UART1 can be switched)
A/D converter		<ul style="list-style-type: none"> <li>Resolution: 10 bits × 8 channels</li> <li>Sample and hold function, sweep mode</li> </ul>
Comparator B		2 circuits
Flash memory		<ul style="list-style-type: none"> <li>Program/erase voltage for program ROM: VCC = 1.8 V to 5.5 V</li> <li>Program/erase voltage for data flash: VCC = 1.8 V to 5.5 V</li> <li>Program/erase endurance: 10,000 times (data flash) 10,000 times (program ROM)</li> <li>Program security: ID code check, protection enabled by lock bit</li> <li>Debug functions: On-chip debug, on-board flash rewrite function</li> </ul>
Operating frequency/ Power supply voltage		f(XIN) = 20 MHz (VCC = 2.7 V to 5.5 V) f(XIN) = 5 MHz (VCC = 1.8 V to 5.5 V)
Temperature range		-20 °C to 85 °C (N version) -40 °C to 85 °C (D version) <sup>(1)</sup>
Package		32-pin LQFP: [Package code] PLQP0032GB-A

Note:

1. Specify the D version if its functions are to be used.

## 1.2 Product List

Table 1.3 lists the Product List. Figure 1.1 shows the Product Part Number Structure.

**Table 1.3 Product List** **Current of Mar 2012**

Part No.	Internal ROM Capacity		Internal RAM Capacity	Package Type	Remarks
	Program ROM	Data Flash			
R5F2M131BNFP	4 Kbytes	1 Kbyte × 2	384 bytes	PLQP0032GB-A	N version
R5F2M132BNFP	8 Kbytes	1 Kbyte × 2	512 bytes		
R5F2M134BNFP	16 Kbytes	1 Kbyte × 2	1 Kbyte		
R5F2M131BDFP	4 Kbytes	1 Kbyte × 2	384 bytes		D version
R5F2M132BDFP	8 Kbytes	1 Kbyte × 2	512 bytes		
R5F2M134BDFP	16 Kbytes	1 Kbyte × 2	1 Kbyte		

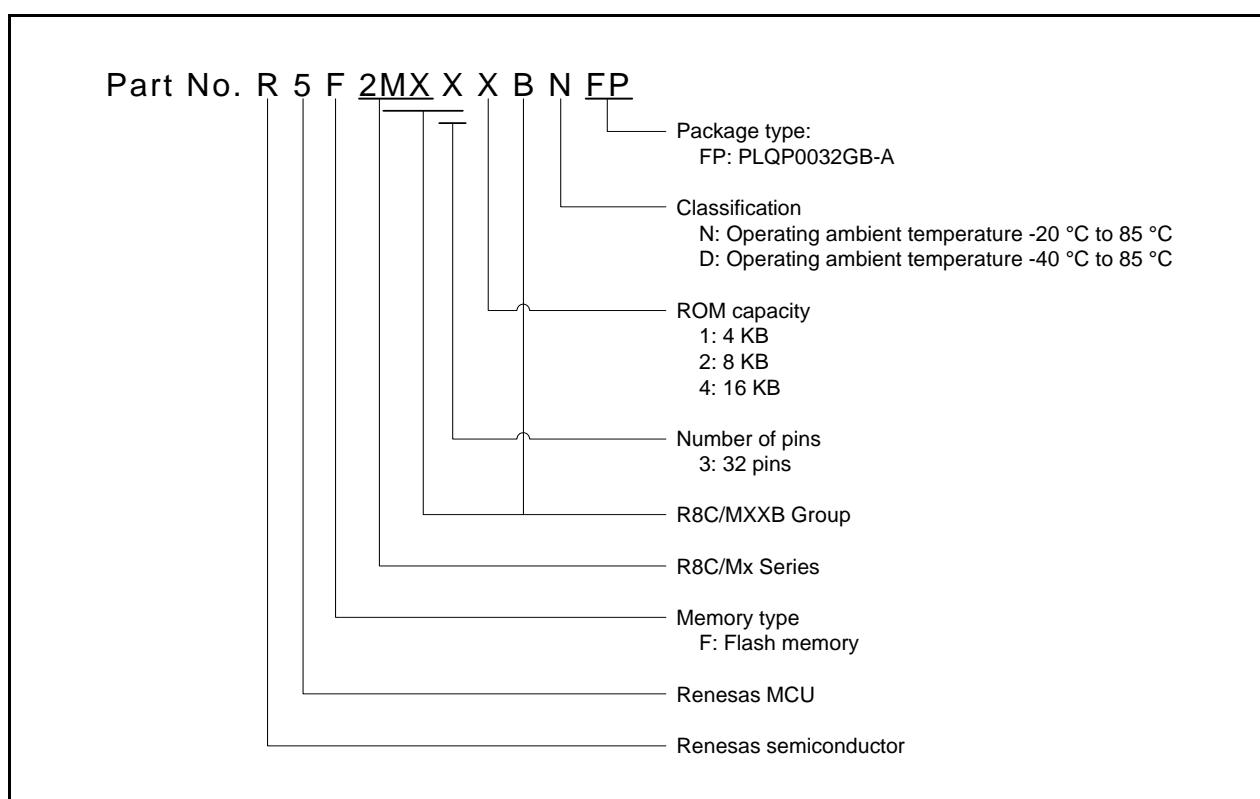

**Figure 1.1 Product Part Number Structure**

### 1.3 Block Diagram

Figure 1.2 shows the Block Diagram.

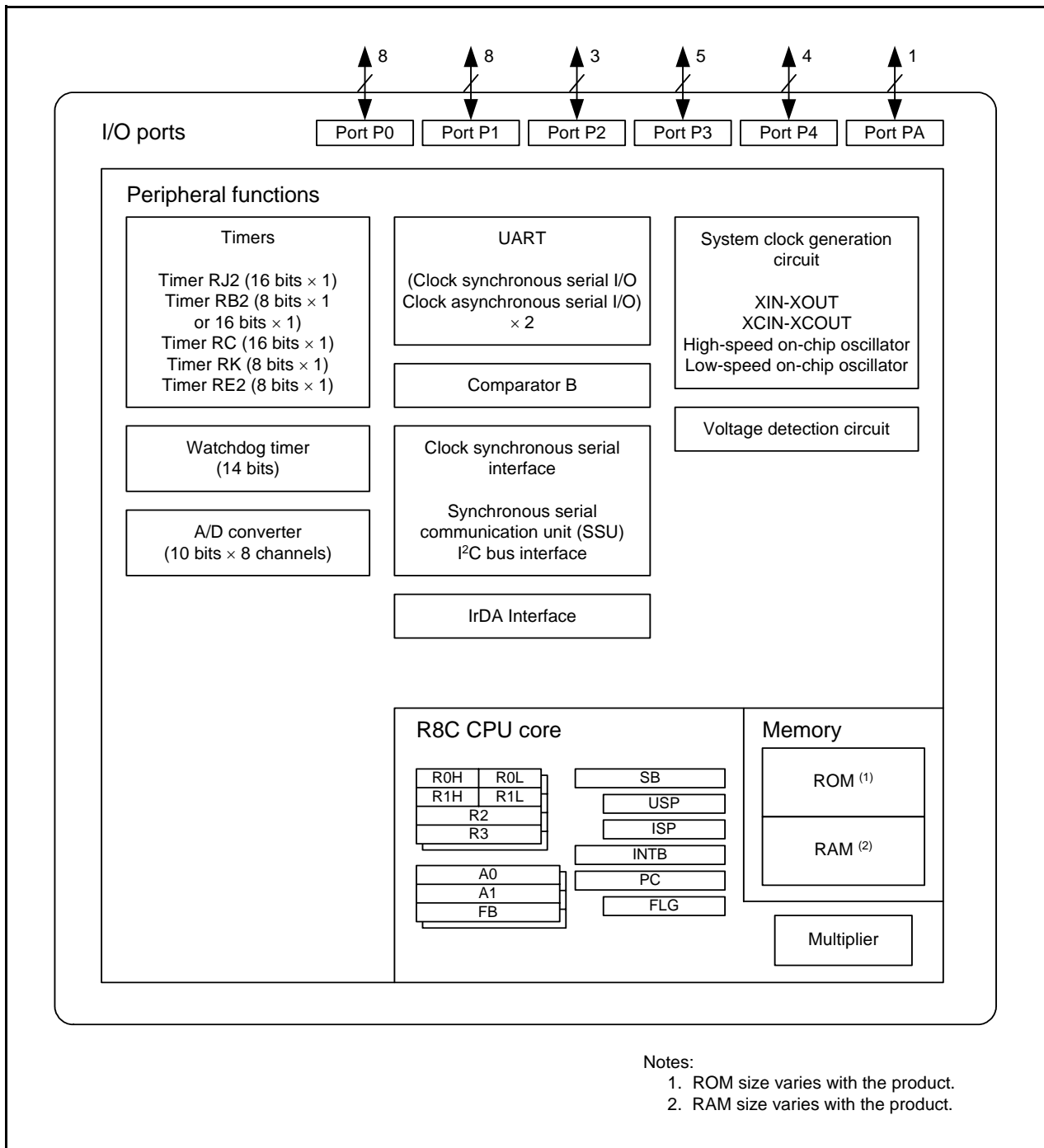
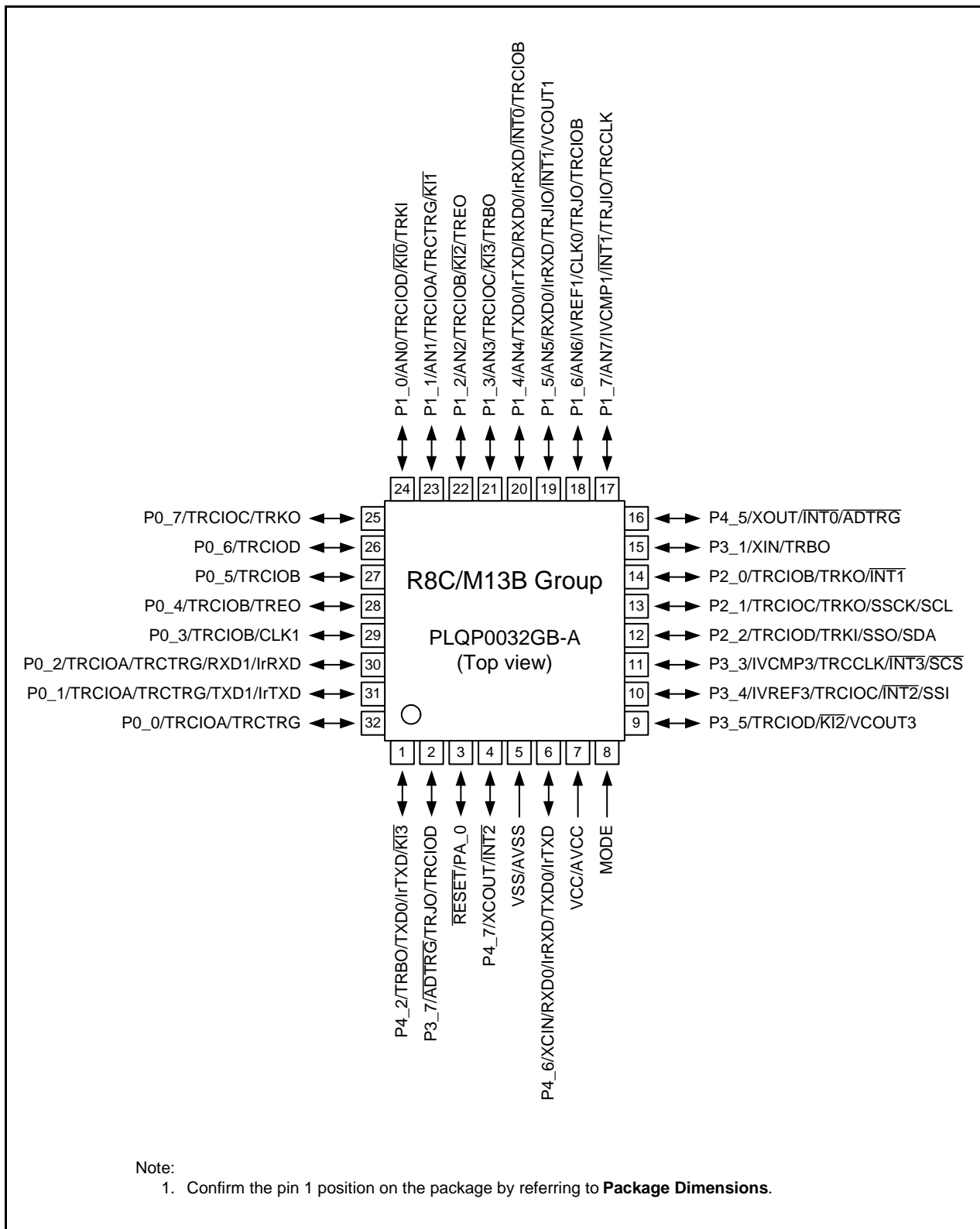

Figure 1.2 Block Diagram

### 1.4 Pin Assignment

Figure 1.3 shows the Pin Assignment (Top View). Table 1.4 lists the Pin Name Information by Pin Number.



**Figure 1.3 Pin Assignment (Top View)**

Table 1.4 Pin Name Information by Pin Number

Pin Number	Control Pin	Port	I/O Pins for Peripheral Functions						
			Interrupt	Timer	Serial Interface	IrDA	SSU	I <sup>2</sup> C bus	A/D Converter, Comparator B
1		P4_2	$\overline{KI3}$	TRBO	TXD0	IrTXD			
2		P3_7		TRJO/TRCIOD					$\overline{ADTRG}$
3	$\overline{RESET}$	PA_0							
4	XCOUT	P4_7	$\overline{INT2}$						
5	VSS/AVSS								
6	XCIN	P4_6			RXD0/TXD0	IrRXD/ IrTXD			
7	VCC/AVCC								
8	MODE								
9		P3_5	$\overline{KI2}$	TRCIOD					VCOUT3
10		P3_4	$\overline{INT2}$	TRCIOC			SSI		IVREF3
11		P3_3	$\overline{INT3}$	TRCCLK			$\overline{SCS}$		IVCMP3
12		P2_2		TRCIOD/TRKI			SSO	SDA	
13		P2_1		TRCIOC/TRKO			SSCK	SCL	
14		P2_0	$\overline{INT1}$	TRCIOB/TRKO					
15	XIN	P3_1		TRBO					
16	XOUT	P4_5	$\overline{INT0}$						$\overline{ADTRG}$
17		P1_7	$\overline{INT1}$	TRJIO/TRCCLK					AN7/IVCMP1
18		P1_6		TRJO/TRCIOB	CLK0				AN6/IVREF1
19		P1_5	$\overline{INT1}$	TRJIO	RXD0	IrRXD			AN5/VCOUT1
20		P1_4	$\overline{INT0}$	TRCIOB	RXD0/TXD0	IrRXD/ IrTXD			AN4
21		P1_3	$\overline{KI3}$	TRBO/TRCIOC					AN3
22		P1_2	$\overline{KI2}$	TRCIOB/TREO					AN2
23		P1_1	$\overline{KI1}$	TRCIOA/TRCTRG					AN1
24		P1_0	$\overline{KI0}$	TRCIOD/TRKI					AN0
25		P0_7		TRCIOC/TRKO					
26		P0_6		TRCIOD					
27		P0_5		TRCIOB					
28		P0_4		TRCIOB/TREO					
29		P0_3		TRCIOB	CLK1				
30		P0_2		TRCIOA/TRCTRG	RXD1	IrRXD			
31		P0_1		TRCIOA/TRCTRG	TXD1	IrTXD			
32		P0_0		TRCIOA/TRCTRG					

## 1.5 Pin Functions

Tables 1.5 and 1.6 list Pin Functions.

**Table 1.5 Pin Functions (1)**

Item	Pin Name	I/O	Description
Power supply input	VCC, VSS	—	Apply 1.8 V through 5.5 V to the VCC pin. Apply 0 V to the VSS pin.
Analog power supply input	AVCC, AVSS	—	Power supply input for the A/D converter. Connect a capacitor between pins AVCC and AVSS.
Reset input	$\overline{\text{RESET}}$	I	Applying a low level to this pin resets the MCU.
MODE	MODE	I	Connect this pin to the VCC pin via a resistor.
XIN clock input	XIN	I	I/O for the XIN clock generation circuit.
XIN clock output	XOUT	O	Connect a ceramic resonator or a crystal oscillator between pins XIN and XOUT. <sup>(1)</sup> To use an external clock, input it to the XIN pin. P4_5 can be used as an I/O port at this time.
XCIN clock input	XCIN	I	I/O for the XCIN clock generation circuit.
XCIN clock output	XCOUT	O	Connect a crystal oscillator between pins XCIN and XCOUT. <sup>(1)</sup> To use an external clock, input it to the XCIN pin. P4_7 can be used as an I/O port at this time.
$\overline{\text{INT}}$ interrupt input	$\overline{\text{INT0}}$ to $\overline{\text{INT3}}$	I	$\overline{\text{INT}}$ interrupt input.
Key input interrupt	$\overline{\text{KI0}}$ to $\overline{\text{KI3}}$	I	Key input interrupt input.
I/O ports	P0_0 to P0_7, P1_0 to P1_7, P2_0 to P2_2, P3_1, P3_3 to P3_5, P3_7, P4_2, P4_5 to P4_7, PA_0	I/O	CMOS I/O ports. Each port has an I/O select direction register, enabling switching input and output for each port. For input ports other than PA_0, the presence or absence of a pull-up resistor can be selected by a program. P1_2 to P1_5, P3_3 to P3_5, and P3_7 can be used as LED drive ports.
Timer RJ2	TRJIO	I/O	Timer RJ2 I/O.
	TRJO	O	Timer RJ2 output.
Timer RB2	TRBO	O	Timer RB2 output.
Timer RC	TRCCLK	I	External clock input.
	TRCTRG	I	External trigger input.
	TRCIOA, TRCIOB, TRCIOC, TRCIOD	I/O	Timer RC I/O.
Timer RK	TRKI	I	Timer RK external input.
	TRKO	O	Timer RK output.
Timer RE2	TREO	O	Timer RE2 output.
Serial interface	CLK0, CLK1	I/O	Transfer clock I/O.
	RXD0, RXD1	I	Serial data input.
	TXD0, TXD1	O	Serial data output.
Synchronous serial communication unit (SSU)	SSI	I/O	Data I/O.
	$\overline{\text{SCS}}$	I/O	Chip-select signal I/O.
	SSO	I/O	Data I/O.
	SSCK	I/O	Clock I/O.
I <sup>2</sup> C bus interface	SDA	I/O	Data I/O.
	SCL	I/O	Clock I/O.
IrDA Interface	IrRXD	I	Data input.
	IrTXD	O	Data output.
A/D converter	AN0 to AN7	I	Analog input for the A/D converter.
	$\overline{\text{ADTRG}}$	I	External trigger input for the A/D converter.

Note:

- Contact the oscillator manufacturer for oscillation characteristics.



**Table 1.6 Pin Functions (2)**

Item	Pin Name	I/O	Description
Comparator B	IVCMP1, IVCMP3	I	Analog voltage input for comparator B.
	IVREF1, IVREF3	I	Reference voltage input for comparator B.
	VCOUT1, VCOUT3	O	Comparison result output for comparator B.

## 2. Central Processing Unit (CPU)

Figure 2.1 shows the 13 CPU Registers. The registers, R0, R1, R2, R3, A0, A1, and FB form a single register bank. The CPU has two register banks.

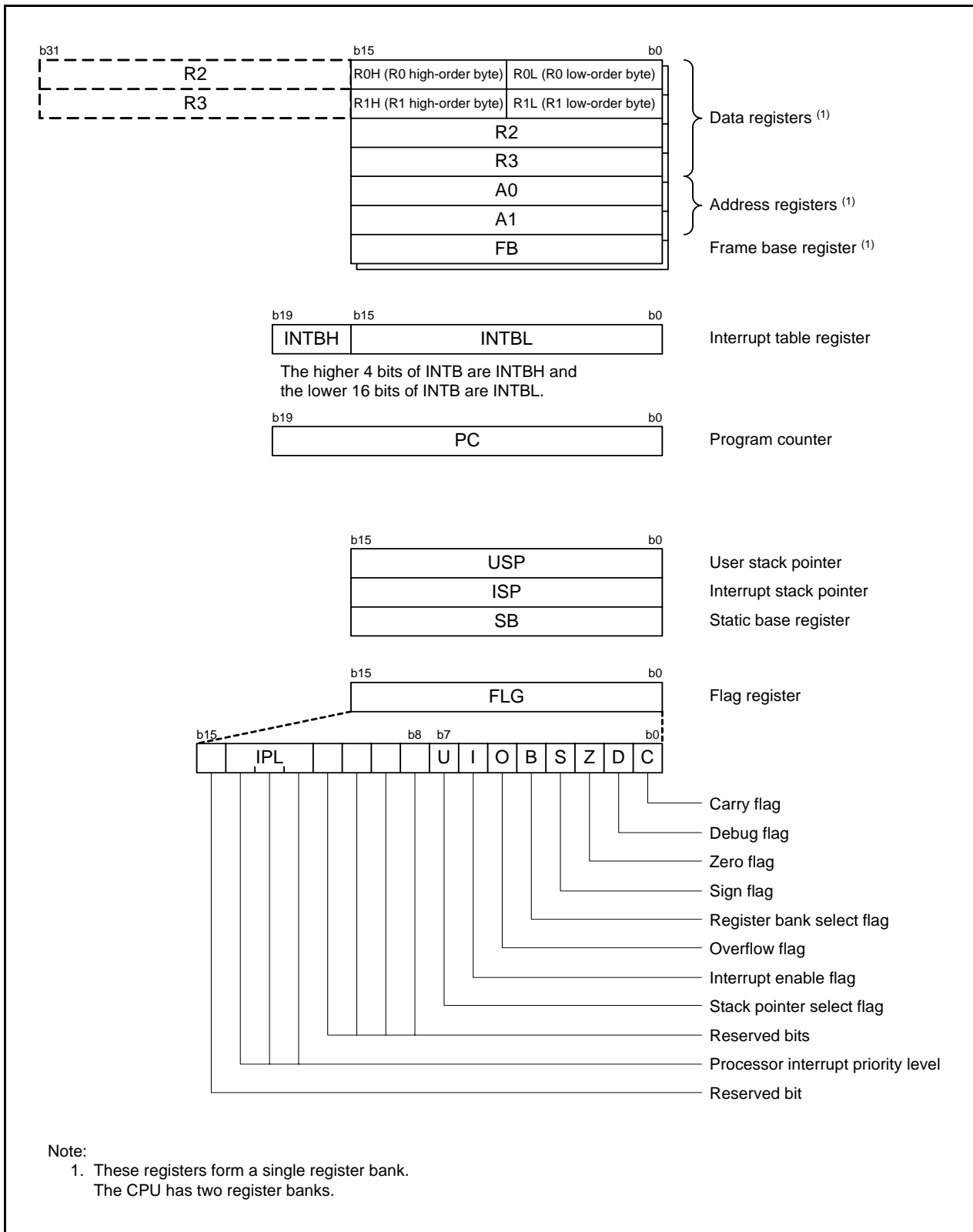

Figure 2.1 CPU Registers

## 2.1 Data Registers (R0, R1, R2, and R3)

R0 is a 16-bit register for transfer, arithmetic, and logic operations. The same applies to R1 through R3.

R0 can be split into high-order (R0H) and low-order (R0L) registers to be used separately as 8-bit data registers. The same applies to R1H and R1L. R2 can be combined with R0 and used as a 32-bit data register (R2R0). In the same way as with R0 and R2, R3 and R1 can be used as a 32-bit data register (R3R1).

## 2.2 Address Registers (A0 and A1)

A0 is a 16-bit register for address register indirect addressing and address register relative addressing. It is also used for transfer, arithmetic, and logic operations. A1 functions in the same manner as A0. A1 can be combined with A0 and used as a 32-bit address register (A1A0).

## 2.3 Frame Base Register (FB)

FB is a 16-bit register used for FB relative addressing.

## 2.4 Interrupt Table Register (INTB)

INTB is a 20-bit register that indicates the start address of a relocatable interrupt vector table.

## 2.5 Program Counter (PC)

PC is a 20-bit register that indicates the address of the next instruction to be executed.

## 2.6 User Stack Pointer (USP) and Interrupt Stack Pointer (ISP)

The stack pointers (SP), USP and ISP, are each 16 bits wide. The U flag of the FLG register is used to switch between USP and ISP.

## 2.7 Static Base Register (SB)

SB is a 16-bit register used for SB relative addressing.

## 2.8 Flag Register (FLG)

FLG is an 11-bit register that indicates the CPU state.

### 2.8.1 Carry Flag (C)

The C flag retains carry, borrow, or shift-out bits that have been generated in the arithmetic and logic unit.

### 2.8.2 Debug Flag (D)

The D flag is for debugging only. It must only be set to 0.

### 2.8.3 Zero Flag (Z)

The Z flag is set to 1 when an arithmetic operation results in 0. Otherwise it is set to 0.

### 2.8.4 Sign Flag (S)

The S flag is set to 1 when an arithmetic operation results in a negative value. Otherwise it is set to 0.

### 2.8.5 Register Bank Select Flag (B)

Register bank 0 is selected when the B flag is 0. Register bank 1 is selected when this flag is 1.

### 2.8.6 Overflow Flag (O)

The O flag is set to 1 when an operation results in an overflow. Otherwise it is set to 0.

### **2.8.7 Interrupt Enable Flag (I)**

The I flag enables maskable interrupts. Interrupts are disabled when the I flag is 0, and are enabled when the I flag is 1. The I flag is set to 0 when an interrupt request is acknowledged.

### **2.8.8 Stack Pointer Select Flag (U)**

ISP is selected when the U flag is 0. USP is selected when the U flag is 1. The U flag is set to 0 when a hardware interrupt request is acknowledged or the INT instruction for a software interrupt numbered from 0 to 31 is executed.

### **2.8.9 Processor Interrupt Priority Level (IPL)**

IPL is 3 bits wide and assigns eight processor interrupt priority levels from 0 to 7. If a requested interrupt has higher priority than IPL, the interrupt is enabled. If IPL is set to levels from 2 to 7, all maskable interrupt requests are disabled.

### **2.8.10 Reserved Bit**

The write value must be 0. The read value is undefined.

## 3. Address Space

### 3.1 Memory Map

Figure 3.1 shows the Memory Map. The R8C/M13B Group have a 1-Mbyte address space from addresses 00000h to FFFFFh. The internal ROM (program ROM) is allocated at lower addresses, beginning with address 0FFFFh. For example, an 8-Kbyte internal ROM area is allocated at addresses 0E000h to 0FFFFh.

The fixed interrupt vector table is allocated at addresses 0FFDCh to 0FFFFh. The start address of each interrupt routine is stored here.

The internal ROM (data flash) is allocated at addresses 03000h to 037FFh.

The internal RAM is allocated at higher addresses, beginning with address 00400h. For example, a 512-byte internal RAM area is allocated at addresses 00400h to 005FFh. The internal RAM is used not only for data storage but also as a stack area when a subroutine is called or when an interrupt request is acknowledged.

Special function registers (SFRs) are allocated at addresses 00000h to 002FFh. Peripheral function control registers are allocated here. All unallocated spaces within the SFRs are reserved and cannot be accessed by users.

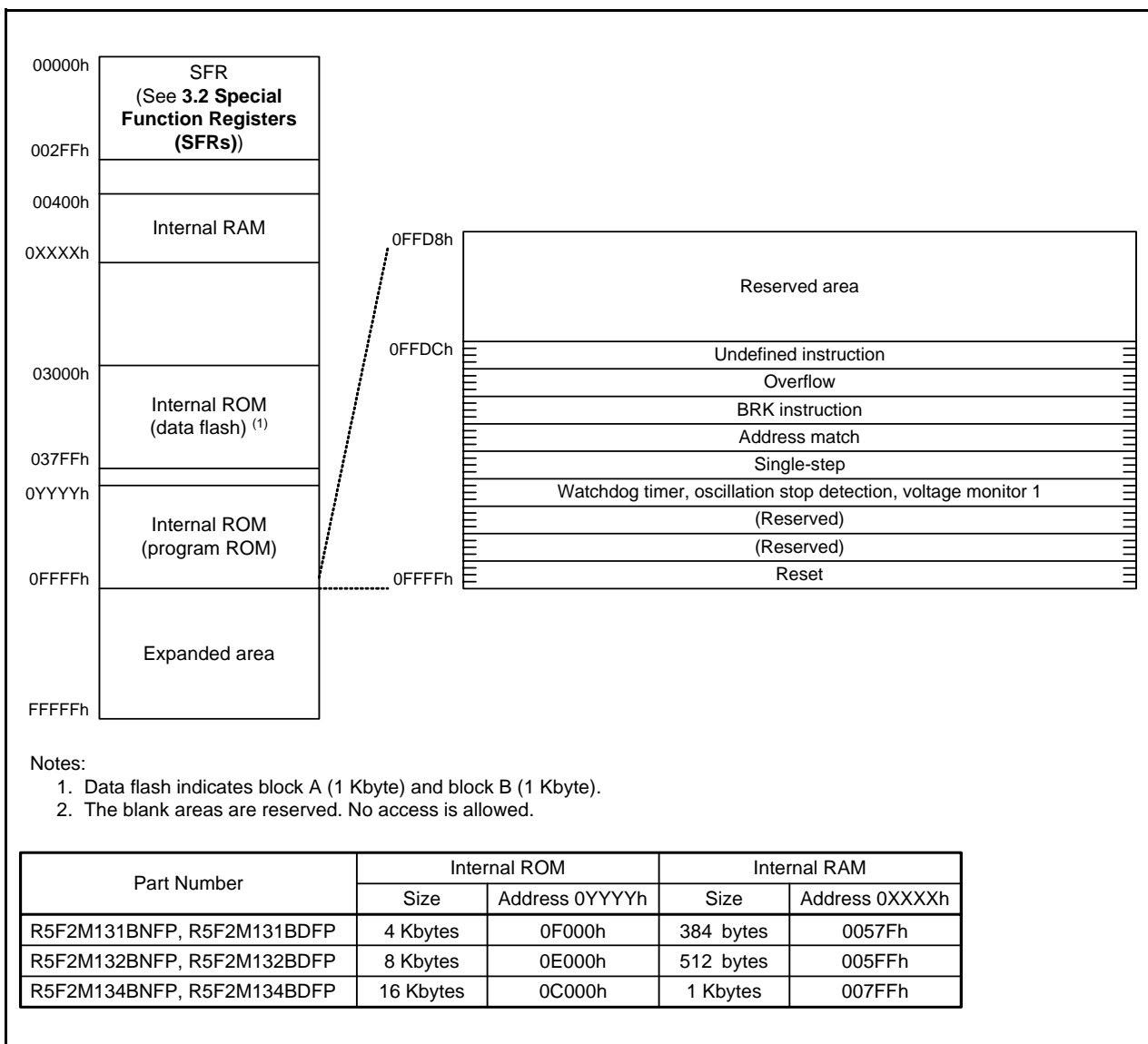

Figure 3.1 Memory Map

### 3.2 Special Function Registers (SFRs)

An SFR (special function register) is a control register for a peripheral function. Tables 3.1 to 3.8 list the SFR Information. Table 3.9 lists the ID Code Area and Option Function Select Area.

**Table 3.1 SFR Information (1) (1)**

Address	Register Name	Symbol	After Reset
00000h			
00001h			
00002h			
00003h			
00004h			
00005h			
00006h			
00007h			
00008h			
00009h			
0000Ah			
0000Bh			
0000Ch			
0000Dh			
0000Eh			
0000Fh			
00010h	Processor Mode Register 0	PM0	00h
00011h			
00012h	Module Standby Control Register	MSTCR	00h (2) 01110111b (3)
00013h	Protect Register	PRCR	00h
00014h			
00015h			
00016h	Hardware Reset Protect Register	HRPR	00h
00017h	Module Standby Control Register 1	MSTCR1	00h (2) FFh (3)
00018h			
00019h			
0001Ah			
0001Bh			
0001Ch			
0001Dh			
0001Eh			
0001Fh			
00020h	External Clock Control Register	EXCKCR	00h
00021h	High-Speed/Low-Speed On-Chip Oscillator Control Register	OCOCR	00h
00022h	System Clock f Control Register	SCKCR	00h
00023h	System Clock f Select Register	PHISEL	00h
00024h	Clock Stop Control Register	CKSTPR	00h
00025h	Clock Control Register When Returning	CKRSCR	00h
00026h	Oscillation Stop Detection Register	BAKCR	00h
00027h			
00028h			
00029h			
0002Ah			
0002Bh			
0002Ch			
0002Dh			
0002Eh			
0002Fh			
00030h	Watchdog Timer Function Register	RISR	1000000b (4) 00h (5)
00031h	Watchdog Timer Reset Register	WDTR	XXh
00032h	Watchdog Timer Start Register	WDTS	XXh
00033h	Watchdog Timer Control Register	WDTC	01XXXXXXb
00034h	Count Source Protection Mode Register	CSPR	1000000b (4) 00h (5)
00035h	Periodic Timer Interrupt Control Register	WDTIR	00h
00036h			
00037h			
00038h	External Input Enable Register	INTEN	00h
00039h			

Notes:

1. The blank areas are reserved. No access is allowed.
2. The MSTINI bit in the OFS2 register is 0.
3. The MSTINI bit in the OFS2 register is 1.
4. The CSPROINI bit in the OFS register is 0.
5. The CSPROINI bit in the OFS register is 1.

**Table 3.2 SFR Information (2) (1)**

Address	Register Name	Symbol	After Reset
0003Ah	INT Input Filter Select Register 0	INTF0	00h
0003Bh			
0003Ch	INT Input Edge Select Register 0	ISCR0	00h
0003Dh			
0003Eh	Key Input Enable Register	KIEN	00h
0003Fh			
00040h	Interrupt Priority Level Register 0	ILVL0	00h
00041h	Interrupt Priority Level Register 1	ILVL1	00h
00042h	Interrupt Priority Level Register 2	ILVL2	00h
00043h	Interrupt Priority Level Register 3	ILVL3	00h
00044h	Interrupt Priority Level Register 4	ILVL4	00h
00045h	Interrupt Priority Level Register 5	ILVL5	00h
00046h	Interrupt Priority Level Register 6	ILVL6	00h
00047h	Interrupt Priority Level Register 7	ILVL7	00h
00048h	Interrupt Priority Level Register 8	ILVL8	00h
00049h	Interrupt Priority Level Register 9	ILVL9	00h
0004Ah	Interrupt Priority Level Register A	ILVLA	00h
0004Bh	Interrupt Priority Level Register B	ILVLB	00h
0004Ch	Interrupt Priority Level Register C	ILVLC	00h
0004Dh	Interrupt Priority Level Register D	ILVLD	00h
0004Eh	Interrupt Priority Level Register E	ILVLE	00h
0004Fh			
00050h	Interrupt Monitor Flag Register 0	IRR0	00h
00051h	Interrupt Monitor Flag Register 1	IRR1	00h
00052h	Interrupt Monitor Flag Register 2	IRR2	00h
00053h	External Interrupt Flag Register	IRR3	00h
00054h			
00055h			
00056h			
00057h			
00058h	Voltage Monitor Circuit Edge Select Register	VCAC	00h
00059h			
0005Ah	Voltage Detect Register 2	VCA2	00100100b (2) 00000100b (3)
0005Bh	Voltage Detection 1 Level Select Register	VD1LS	00000111b
0005Ch	Voltage Monitor 0 Circuit Control Register	VW0C	1100X011b (2) 1100X010b (3)
0005Dh	Voltage Monitor 1 Circuit Control Register	VW1C	10001010b
0005Eh			
0005Fh	Reset Source Determination Register	RSTFR	0000XXXXb (4)
00060h			
00061h			
00062h			
00063h			
00064h	High-Speed On-Chip Oscillator 18.432 MHz Control Register 0	FR18S0	Value when shipped
00065h	High-Speed On-Chip Oscillator 18.432 MHz Control Register 1	FR18S1	Value when shipped
00066h			
00067h	High-Speed On-Chip Oscillator Control Register 1	FRV1	Value when shipped
00068h	High-Speed On-Chip Oscillator Control Register 2	FRV2	Value when shipped
00069h			
0006Ah			
0006Bh			
0006Ch			
0006Dh			
0006Eh			
0006Fh			
00070h			
00071h			
00072h			
00073h			
00074h			
00075h			
00076h			
00077h			
00078h			
00079h			

X: Undefined

Notes:

1. The blank areas are reserved. No access is allowed.
2. The LVDAS bit in the OFS register is 0.
3. The LVDAS bit in the OFS register is 1.
4. The value after a reset differs depending on the reset source.

**Table 3.3 SFR Information (3) (1)**

Address	Register Name	Symbol	After Reset
0007Ah			
0007Bh			
0007Ch			
0007Dh			
0007Eh			
0007Fh			
00080h	UART0 Transmit/Receive Mode Register	U0MR	00h
00081h	UART0 Bit Rate Register	U0BRG	XXh
00082h	UART0 Transmit Buffer Register	U0TBL	XXh
00083h		U0TBH	XXh
00084h	UART0 Transmit/Receive Control Register 0	U0C0	00001000b
00085h	UART0 Transmit/Receive Control Register 1	U0C1	00000010b
00086h	UART0 Receive Buffer Register	U0RBL	XXh
00087h		U0RBH	XXh
00088h	UART0 Interrupt Flag and Enable Register	U0IR	00h
00089h			
0008Ah			
0008Bh			
0008Ch			
0008Dh			
0008Eh			
0008Fh			
00090h			
00091h			
00092h			
00093h			
00094h			
00095h			
00096h			
00097h			
00098h	A/D Register 0	AD0L	XXh
00099h		AD0H	000000XXb
0009Ah	A/D Register 1	AD1L	XXh
0009Bh		AD1H	000000XXb
0009Ch	A/D Mode Register	ADMOD	00h
0009Dh	A/D Input Select Register	ADINSEL	00h
0009Eh	A/D Control Register 0	ADCON0	00h
0009Fh	A/D Interrupt Control Status Register	ADICSR	00h
000A0h			
000A1h			
000A2h			
000A3h			
000A4h			
000A5h			
000A6h			
000A7h			
000A8h	Port P0 Direction Register	PD0	00h
000A9h	Port P1 Direction Register	PD1	00h
000AAh	Port P2 Direction Register	PD2	00h
000ABh	Port P3 Direction Register	PD3	00h
000ACh	Port P4 Direction Register	PD4	00h
000ADh	Port PA Direction Register	PDA	00h
000AEh	Port P0 Register	P0	00h
000AFh	Port P1 Register	P1	00h
000B0h	Port P2 Register	P2	00h
000B1h	Port P3 Register	P3	00h
000B2h	Port P4 Register	P4	00h
000B3h	Port PA Register	PA	00h
000B4h	Pull-Up Control Register 0	PUR0	00h
000B5h	Pull-Up Control Register 1	PUR1	00h
000B6h	Pull-Up Control Register 2	PUR2	00h
000B7h	Pull-Up Control Register 3	PUR3	00h
000B8h	Pull-Up Control Register 4	PUR4	00h
000B9h	Port I/O Function Control Register	PINSR	00h
000BAh			
000BBh	Drive Capacity Control Register 1	DRR1	00h
000BCh			
000BDh	Drive Capacity Control Register 3	DRR3	00h
000BEh			
000BFh			

X: Undefined

Note:

1. The blank areas are reserved. No access is allowed.



**Table 3.4 SFR Information (4) (1)**

Address	Register Name	Symbol	After Reset
000C0h	Open-Drain Control Register 0	POD0	00h
000C1h	Open-Drain Control Register 1	POD1	00h
000C2h	Open-Drain Control Register 2	POD2	00h
000C3h	Open-Drain Control Register 3	POD3	00h
000C4h	Open-Drain Control Register 4	POD4	00h
000C5h	Port PA Mode Control Register	PAMCR	11h
000C6h	Port 0 Function Mapping Register 0	PML0	00h
000C7h	Port 0 Function Mapping Register 1	PMH0	00h
000C8h	Port 1 Function Mapping Register 0	PML1	00h
000C9h	Port 1 Function Mapping Register 1	PMH1	00h
000CAh	Port 2 Function Mapping Register 0	PML2	00h
000CBh			
000CCh	Port 3 Function Mapping Register 0	PML3	00h
000CDh	Port 3 Function Mapping Register 1	PMH3	00h
000CEh	Port 4 Function Mapping Register 0	PML4	00h
000CFh	Port 4 Function Mapping Register 1	PMH4	00h
000D0h			
000D1h	Port 1 Function Mapping Expansion Register	PMH1E	00h
000D2h			
000D3h			
000D4h			
000D5h			
000D6h			
000D7h			
000D8h	Timer RJ Counter Register	TRJ	FFh
000D9h			FFh
000DAh	Timer RJ Control Register	TRJCR	00h
000DBh	Timer RJ I/O Control Register	TRJIOC	00h
000DCh	Timer RJ Mode Register	TRJMR	00h
000DDh	Timer RJ Event Select Register	TRJISR	00h
000DEh	Timer RJ Interrupt Control Register	TRJIR	00h
000DFh			
000E0h	Timer RB Control Register	TRBCR	00h
000E1h	Timer RB One-Shot Control Register	TRBOCR	00h
000E2h	Timer RB I/O Control Register	TRBIOC	00h
000E3h	Timer RB Mode Register	TRBMR	00h
000E4h	Timer RB Prescaler Register (2) Timer RB Primary/Secondary Register (Lower 8 Bits) (3)	TRBPRE	FFh
000E5h	Timer RB Primary Register (2) Timer RB Primary Register (Higher 8 Bits) (3)	TRBPR	FFh
000E6h	Timer RB Secondary Register (2) Timer RB Secondary Register (Higher 8 Bits) (3)	TRBSC	FFh
000E7h	Timer RB Interrupt Control Register	TRBIR	00h
000E8h	Timer RC Counter	TRCCNT	00h
000E9h			00h
000EAh	Timer RC General Register A	TRCGRA	FFh
000EBh			FFh
000ECh	Timer RC General Register B	TRCGRB	FFh
000EDh			FFh
000EEh	Timer RC General Register C	TRCGRC	FFh
000EFh			FFh
000F0h	Timer RC General Register D	TRCGRD	FFh
000F1h			FFh
000F2h	Timer RC Mode Register	TRCMR	01001000b
000F3h	Timer RC Control Register 1	TRCCR1	00h
000F4h	Timer RC Interrupt Enable Register	TRCIER	01110000b
000F5h	Timer RC Status Register	TRCSR	01110000b
000F6h	Timer RC I/O Control Register 0	TRCIOR0	10001000b
000F7h	Timer RC I/O Control Register 1	TRCIOR1	10001000b
000F8h	Timer RC Control Register 2	TRCCR2	00011000b
000F9h	Timer RC Digital Filter Function Select Register	TRCDF	00h
000FAh	Timer RC Output Enable Register	TRCOER	01111111b
000FBh	Timer RC A/D Conversion Trigger Control Register	TRCADCR	11110000b
000FCh	Timer RC Waveform Output Manipulation Register	TRCOPR	00h
000FDh			
000FEh			
000FFh			

## Notes:

1. The blank areas are reserved. No access is allowed.
2. The TCNT16 bit in the TRBMR register is 0.
3. The TCNT16 bit in the TRBMR register is 1.

**Table 3.5 SFR Information (5) (1)**

Address	Register Name	Symbol	After Reset
00100h			
00101h			
00102h			
00103h			
00104h			
00105h			
00106h			
00107h			
00108h			
00109h			
0010Ah			
0010Bh			
0010Ch			
0010Dh			
0010Eh			
0010Fh			
00110h			
00111h			
00112h			
00113h			
00114h			
00115h			
00116h			
00117h			
00118h			
00119h			
0011Ah			
0011Bh			
0011Ch			
0011Dh			
0011Eh			
0011Fh			
00120h			
00121h			
00122h			
00123h			
00124h			
00125h			
00126h			
00127h			
00128h			
00129h			
0012Ah			
0012Bh			
0012Ch			
0012Dh			
0012Eh			
0012Fh			
00130h	Timer RE Second Data Register	TRESEC	XXXXXXXXb
	Timer RE Counter Data Register	TRECNT	
00131h	Timer RE Minute Data Register	TREMIN	XXXXXXXXb
	Timer RE Compare Data Register		
00132h	Timer RE Hour Data Register	TREHR	00XXXXXXb
00133h	Timer RE Day-of-the-Week Data Register	TREWK	0000XXXXb
00134h	Timer RE Day Data Register	TREDY	00XXXXXXb
00135h	Timer RE Month Data Register	TREMON	000XXXXXb
00136h	Timer RE Year Data Register	TREYR	XXXXXXXXb
00137h	Timer RE Control Register	TRECR	XXX00X0b
00138h	Timer RE Count Source Select Register	TRECSR	X0001000b
00139h	Timer RE Clock Error Correction Register	TREADJ	XXXXXXXXb
0013Ah	Timer RE Interrupt Flag Register	TREIFR	0000XXXXb
0013Bh	Timer RE Interrupt Enable Register	TREIER	XXXXXXXXb
0013Ch	Timer RE Alarm Minute Register	TREAMN	XXXXXXXXb
0013Dh	Timer RE Alarm Hour Register	TREahr	XXXXXXXXb
0013Eh	Timer RE Alarm Day-of-the-Week Register	TREAWK	X0000XXXb
0013Fh	Timer RE Protect Register	TREPRC	00000000b

X: Undefined

Note:

1. The blank areas are reserved. No access is allowed.

**Table 3.6 SFR Information (6) (1)**

Address	Register Name	Symbol	After Reset
00140h			
00141h			
00142h			
00143h			
00144h			
00145h			
00146h			
00147h			
00148h			
00149h			
0014Ah			
0014Bh			
0014Ch			
0014Dh			
0014Eh			
0014Fh			
00150h			
00151h			
00152h			
00153h			
00154h			
00155h			
00156h			
00157h			
00158h			
00159h			
0015Ah			
0015Bh			
0015Ch			
0015Dh			
0015Eh			
0015Fh			
00160h	IIC Control Register	IICCR	00001110b
00161h	SS Bit Counter Register	SSBR	11111000b
00162h	SI Transmit Data Register	SITDR	FFh
00163h			FFh
00164h	SI Receive Data Register	SIRDR	FFh
00165h			FFh
00166h	SI Control Register 1	SICR1	00h
00167h	SI Control Register 2	SICR2	01111101b
00168h	SI Mode Register 1	SIMR1	00010000b (2) 00011000b (3)
00169h	SI Interrupt Enable Register	SIER	00h
0016Ah	SI Status Register	SISR	00h
0016Bh	SI Mode Register 2	SIMR2	00h
0016Ch			
0016Dh			
0016Eh			
0016Fh			
00170h			
00171h			
00172h			
00173h			
00174h			
00175h			
00176h			
00177h			
00178h			
00179h			
0017Ah			
0017Bh			
0017Ch			
0017Dh			
0017Eh			
0017Fh			

Notes:

1. The blank areas are reserved. No access is allowed.
2. When the SSU function is used.
3. When the I<sup>2</sup>C bus function is used.

**Table 3.7 SFR Information (7) (1)**

Address	Register Name	Symbol	After Reset
00180h	Comparator B Control Register	WCMPR	00h
00181h	Comparator B1 Interrupt Control Register	WCB1INTR	00h
00182h	Comparator B3 Interrupt Control Register	WCB3INTR	00h
00183h			
00184h			
00185h			
00186h			
00187h			
00188h	Timer RK Mode Register	TMKM	00h
00189h	Timer RK Control Register	TMKCR	00h
0018Ah	Timer RK Load Register	TMKLD (TMKCNT)	00h
0018Bh	Timer RK Compare Match Data Register	TMKCMP	00h
0018Ch	Timer RK Interrupt Request and Status Register	TMKIR	00h
0018Dh			
0018Eh			
0018Fh			
00190h	UART1 Transmit/Receive Mode Register	U1MR	00h
00191h	UART1 Bit Rate Register	U1BRG	XXh
00192h	UART1 Transmit Buffer Register	U1TBL	XXh
00193h		U1TBH	XXh
00194h	UART1 Transmit/Receive Control Register 0	U1C0	00001000b
00195h	UART1 Transmit/Receive Control Register 1	U1C1	00000010b
00196h	UART1 Receive Buffer Register	U1RBL	XXh
00197h		U1RBH	XXh
00198h	UART1 Interrupt Flag and Enable Register	U1IR	00h
00199h			
0019Ah			
0019Bh			
0019Ch	IrDA Control Register	IRCR	00h
0019Dh			
0019Eh			
0019Fh			
001A0h			
001A1h			
001A2h			
001A3h			
001A4h			
001A5h			
001A6h			
001A7h			
001A8h			
001A9h	Flash Memory Status Register	FST	10000000b
001AAh	Flash Memory Control Register 0	FMR0	00h
001ABh	Flash Memory Control Register 1	FMR1	00h
001ACh	Flash Memory Control Register 2	FMR2	00h
001ADh	Flash Memory Refresh Control Register	FREFR	00h
001AEh			
001AFh			
001B0h			
001B1h			
001B2h			
001B3h			
001B4h			
001B5h			
001B6h			
001B7h			
001B8h			
001B9h			
001BAh			
001BBh			
001BCh			
001BDh			
001BEh			
001BFh			

X: Undefined

Note:

1. The blank areas are reserved. No access is allowed.

**Table 3.8 SFR Information (8) (1)**

Address	Register Name	Symbol	After Reset
001C0h	Address Match Interrupt Register 0	AIADR0L	00h
001C1h		AIADR0M	00h
001C2h		AIADR0H	00h
001C3h	Address Match Interrupt Enable Register 0	AIEN0	00h
001C4h	Address Match Interrupt Register 1	AIADR1L	00h
001C5h		AIADR1M	00h
001C6h		AIADR1H	00h
001C7h	Address Match Interrupt Enable Register 1	AIEN1	00h
001C8h			
001C9h			
001CAh			
001CBh			
001CCh			
001CDh			
001CEh			
001CFh			
001D0h			
001D1h			
001D2h			
001D3h			
001D4h			
001D5h			
001D6h			
001D7h			
001D8h			
001D9h			
001DAh			
001DBh			
001DCh			
001DDh			
001DEh			
001DFh			
001E0h			
001E1h			
001E2h			
001E3h			
001E4h			
001E5h			
001E6h			
001E7h			
001E8h			
001E9h			
001EAh			
001EBh			
001ECh			
001EDh			
001EEh			
001EFh			
001F0h			
001F1h			
001F2h			
001F3h			
001F4h			
001F5h			
001F6h			
001F7h			
001F8h			
001F9h			
001FAh			
001FBh			
001FCh			
001FDh			
001FEh			
001FFh			

Note:

1. The blank areas are reserved. No access is allowed.

**Table 3.9 ID Code Area and Option Function Select Area**

Address	Area Name	Symbol	After Reset
0FFDBh	Option Function Select Register 2	OFS2	(Note 1)
0FFDFh	ID1		(Note 2)
0FFE3h	ID2		(Note 2)
0FFEBh	ID3		(Note 2)
0FFEFh	ID4		(Note 2)
0FFF3h	ID5		(Note 2)
0FFF7h	ID6		(Note 2)
0FFFBh	ID7		(Note 2)
0FFFFh	Option Function Select Register	OFS	(Note 1)

## Notes:

- The option function select area is allocated in the flash memory, not in the SFRs. Set appropriate values as ROM data by a program. Do not perform an additional write to the option function select area. Erasure of the block including the option function select area causes the option function select area to be set to FFh.  
When blank products are shipped, the option function select area is set to FFh. It is set to the written value after written by the user.  
When factory-programming products are shipped, the value of the option function select area is the value programmed by the user.
- The ID code area is allocated in the flash memory, not in the SFRs. Set appropriate values as ROM data by a program. Do not perform an additional write to the ID code area. Erasure of the block including the ID code area causes the ID code area to be set to FFh. When blank products are shipped, the ID code areas are set to FFh. They are set to the written value after written by the user.  
When factory-programming products are shipped, the value of the ID code areas is the value programmed by the user.

## 4. Electrical Characteristics

**Table 4.1 Absolute Maximum Ratings**

Symbol	Parameter		Condition	Rated Value	Unit
V <sub>CC</sub> /AV <sub>CC</sub>	Power supply voltage			-0.3 to 6.5	V
V <sub>i</sub>	Input voltage	XIN	XIN-XOUT oscillation on (oscillation circuit used) <sup>(1)</sup>	-0.3 to 1.9	V
			XIN-XOUT oscillation off (oscillation circuit not used) <sup>(1)</sup>	-0.3 to V <sub>CC</sub> + 0.3	V
		Other pins		-0.3 to V <sub>CC</sub> + 0.3	V
V <sub>o</sub>	Output voltage	XOUT	XIN-XOUT oscillation on (oscillation circuit used) <sup>(1)</sup>	-0.3 to 1.9	V
			XIN-XOUT oscillation off (oscillation circuit not used) <sup>(1)</sup>	-0.3 to V <sub>CC</sub> + 0.3	V
		Other pins		-0.3 to V <sub>CC</sub> + 0.3	V
P <sub>d</sub>	Power consumption		-40 °C ≤ Topr ≤ 85 °C	500	mW
T <sub>opr</sub>	Operating ambient temperature			-20 to 85 (N version)/ -40 to 85 (D version)	°C
T <sub>stg</sub>	Storage temperature			-60 to 150	°C

Note:

- When the oscillation circuit is used: bits CKPT1 to CKPT0 in the EXCKCR register are set to 11b  
When the oscillation circuit is not used: bits CKPT1 to CKPT0 in the EXCKCR register are set to any value other than 11b

**Table 4.2 Recommended Operating Conditions**

Symbol	Parameter		Condition	Standard			Unit
				Min.	Typ.	Max.	
V <sub>CC</sub> /AV <sub>CC</sub>	Power supply voltage			1.8	—	5.5	V
V <sub>SS</sub> /AV <sub>SS</sub>	Power supply voltage			—	0	—	V
V <sub>IH</sub>	Input high voltage	Other than CMOS input		0.8 V <sub>CC</sub>	—	V <sub>CC</sub>	V
		CMOS input	4.0 V ≤ V <sub>CC</sub> ≤ 5.5 V	0.65 V <sub>CC</sub>	—	V <sub>CC</sub>	V
			2.7 V ≤ V <sub>CC</sub> < 4.0 V	0.7 V <sub>CC</sub>	—	V <sub>CC</sub>	V
			1.8 V ≤ V <sub>CC</sub> < 2.7 V	0.8 V <sub>CC</sub>	—	V <sub>CC</sub>	V
V <sub>IL</sub>	Input low voltage	Other than CMOS input		0	—	0.2 V <sub>CC</sub>	V
		CMOS input	4.0 V ≤ V <sub>CC</sub> ≤ 5.5 V	0	—	0.4 V <sub>CC</sub>	V
			2.7 V ≤ V <sub>CC</sub> < 4.0 V	0	—	0.3 V <sub>CC</sub>	V
			1.8 V ≤ V <sub>CC</sub> < 2.7 V	0	—	0.2 V <sub>CC</sub>	V
I <sub>OH(sum)</sub>	Peak sum output high current	Sum of all pins I <sub>OH(peak)</sub>		—	—	-160	mA
I <sub>OH(sum)</sub>	Average sum output high current	Sum of all pins I <sub>OH(avg)</sub>		—	—	-80	mA
I <sub>OH(peak)</sub>	Peak output high current		When drive capacity is low	—	—	-10	mA
			When drive capacity is high <sup>(5)</sup>	—	—	-40	mA
I <sub>OH(avg)</sub>	Average output high current		When drive capacity is low	—	—	-5	mA
			When drive capacity is high <sup>(5)</sup>	—	—	-20	mA
I <sub>OL(sum)</sub>	Peak sum output low current	Sum of all pins I <sub>OL(peak)</sub>		—	—	160	mA
I <sub>OL(sum)</sub>	Average sum output low current	Sum of all pins I <sub>OL(avg)</sub>		—	—	80	mA
I <sub>OL(peak)</sub>	Peak output low current		When drive capacity is low	—	—	10	mA
			When drive capacity is high <sup>(5)</sup>	—	—	40	mA
I <sub>OL(avg)</sub>	Average output low current		When drive capacity is low	—	—	5	mA
			When drive capacity is high <sup>(5)</sup>	—	—	20	mA
f <sub>(XIN)</sub>	XIN oscillation frequency		2.7 V ≤ V <sub>CC</sub> ≤ 5.5 V	2	—	20	MHz
			1.8 V ≤ V <sub>CC</sub> < 2.7 V	2	—	5	MHz
	XIN clock input oscillation frequency		2.7 V ≤ V <sub>CC</sub> ≤ 5.5 V	0	—	20	MHz
			1.8 V ≤ V <sub>CC</sub> < 2.7 V	0	—	5	MHz
f <sub>(XCIN)</sub>	XCIN clock input oscillation frequency		1.8 V ≤ V <sub>CC</sub> ≤ 5.5 V	—	32.768	—	kHz
f <sub>HOCO</sub>	High-speed on-chip oscillator oscillation frequency <sup>(3)</sup>		1.8 V ≤ V <sub>CC</sub> ≤ 5.5 V	—	20	—	MHz
f <sub>LOCO</sub>	Low-speed on-chip oscillator oscillation frequency <sup>(4)</sup>		1.8 V ≤ V <sub>CC</sub> ≤ 5.5 V	—	125	—	kHz
—	System clock frequency		2.7 V ≤ V <sub>CC</sub> ≤ 5.5 V	—	—	20	MHz
			1.8 V ≤ V <sub>CC</sub> < 2.7 V	—	—	5	MHz
f <sub>s</sub>	CPU clock frequency		2.7 V ≤ V <sub>CC</sub> ≤ 5.5 V	0	—	20	MHz
			1.8 V ≤ V <sub>CC</sub> < 2.7 V	0	—	5	MHz

## Notes:

1. V<sub>CC</sub> = 1.8 V to 5.5 V and T<sub>opr</sub> = -20 °C to 85 °C (N version)/-40 °C to 85 °C (D version), unless otherwise specified.
2. The average output current indicates the average value of current measured during 100 ms.
3. For details, see **Table 4.10 High-Speed On-Chip Oscillator Circuit Electrical Characteristics**.
4. For details, see **Table 4.11 Low-Speed On-Chip Oscillator Circuit Electrical Characteristics**.
5. The pins with high drive capacity are P1\_2, P1\_3, P1\_4, P1\_5, P3\_3, P3\_4, P3\_5, and P3\_7.



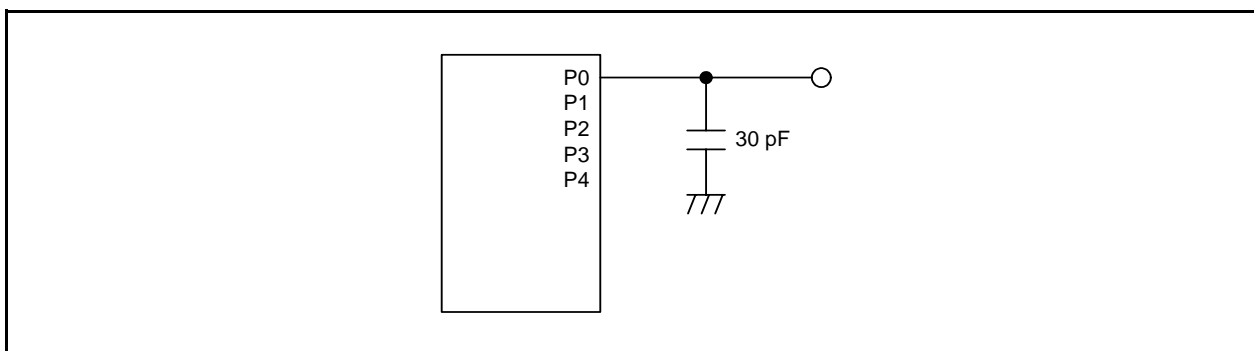

Figure 4.1 Ports P0 to P4 Timing Measurement Circuit

Table 4.3 A/D Converter Characteristics

Symbol	Parameter	Condition	Standard			Unit
			Min.	Typ.	Max.	
—	Resolution		—	—	10	Bit
—	Absolute accuracy	AVcc = 5.0 V AN0 to AN7 input	—	—	±3	LSB
		AVcc = 3.0 V AN0 to AN7 input	—	—	±5	LSB
		AVcc = 1.8 V AN0 to AN7 input	—	—	±5	LSB
—	A/D conversion clock	4.0 V ≤ AVcc ≤ 5.5 V (2)	2	—	20	MHz
		3.2 V ≤ AVcc ≤ 5.5 V (2)	2	—	16	MHz
		2.7 V ≤ AVcc ≤ 5.5 V (2)	2	—	10	MHz
		1.8 V ≤ AVcc ≤ 5.5 V (2)	2	—	5	MHz
—	Permissible signal source impedance			3		kΩ
tCONV	Conversion time	AVcc = 5.0 V, φAD = 20 MHz	2.20	—	—	μs
tsAMP	Sampling time	φAD = 20 MHz	0.80	—	—	μs
VIA	Analog input voltage		0	—	AVcc	V

Notes:

- Vcc/AVcc = 1.8 V to 5.5 V and Vss = 0 V and Topr = -20 °C to 85 °C (N version)/-40 °C to 85 °C (D version), unless otherwise specified.
- The A/D conversion result will be undefined in stop mode, or when the flash memory is in low-current-consumption read mode or stopped. Do not perform A/D conversion in these states. Do not enter these states during A/D conversion.

Table 4.4 Comparator B Electrical Characteristics

Symbol	Parameter	Condition	Standard			Unit
			Min.	Typ.	Max.	
Vref	IVREF1, IVREF3 input reference voltage		0	—	Vcc - 1.4	V
Vi	IVCMP1, IVCMP3 input voltage		-0.3	—	Vcc + 0.3	V
—	Offset		—	5	100	mV
td	Comparator output delay time (2)	Vi = Vref ± 100 mV	—	0.1	—	μs
IcMP	Comparator operating current	Vcc = 5.0 V	—	17.5	—	μA

Notes:

- Vcc = 2.7 V to 5.5 V and Topr = -20 °C to 85 °C (N version)/-40 °C to 85 °C (D version), unless otherwise specified.
- When the digital filter is disabled.

**Table 4.5 Flash Memory (Program ROM) Electrical Characteristics**

Symbol	Parameter	Condition	Standard			Unit
			Min.	Typ.	Max.	
—	Program/erase endurance <sup>(2)</sup>		10,000 <sup>(3)</sup>	—	—	times
—	Byte programming time (program/erase endurance ≤ 1,000 times)		—	80	—	μs
—	Byte programming time (program/erase endurance > 1,000 times)		—	160	—	μs
—	Block erase time		—	0.12	—	s
t <sub>d</sub> (SR-SUS)	Transition time to suspend		—	—	0.25 + CPU clock × 3 cycles	ms
—	Time from suspend until erase restart		—	—	30 + CPU clock × 1 cycle	μs
t <sub>d</sub> (CMDRST READY)	Time from when command is forcibly terminated until reading is enabled		—	—	30 + CPU clock × 1 cycle	μs
—	Program/erase voltage		1.8	—	5.5	V
—	Read voltage		1.8	—	5.5	V
—	Program/erase temperature		0	—	60	°C
—	Data hold time <sup>(7)</sup>	Ambient temperature = 85 °C	10	—	—	years

## Notes:

- V<sub>cc</sub> = 2.7 V to 5.5 V and T<sub>opr</sub> = 0 °C to 60 °C, unless otherwise specified.
- Definition of program/erase endurance  
The number of program/erase cycles is defined on a per-block basis.  
If the number of cycles is 10,000, each block can be erased 10,000 times.  
For example, if 1,024 cycles of 1-byte-write are performed to different addresses in 1 Kbyte of block A, and then the block is erased, the number of cycles is counted as one. Note, however, that the same address must not be programmed more than once before completion of an erase (overwriting prohibited).
- This indicates the number of times up to which all electrical characteristics can be guaranteed after the last programming/erase operation. Operation is guaranteed for any number of operations in the range of 1 to the specified minimum (Min).
- In a system that executes multiple programming operations, the actual erase count can be reduced by shifting the write addresses in sequence and programming so that as much of the flash memory as possible is used before performing an erase operation. For example, when programming in 16-byte units, the effective number of rewrites can be minimized by programming up to 128 units before erasing them all in one operation. It is also advisable to retain data on the number of erase operations for each block and establish a limit for the number of erase operations performed.
- If an error occurs during a block erase, execute a clear status register command and then a block erase command at least three times until the erase error does not occur.
- For information on the program/erase failure rate, contact a Renesas technical support representative.
- The data hold time includes the time that the power supply is off and the time the clock is not supplied.

**Table 4.6 Flash Memory (Blocks A and B of Data Flash) Electrical Characteristics**

Symbol	Parameter	Condition	Standard			Unit
			Min.	Typ.	Max.	
—	Program/erase endurance <sup>(2)</sup>		10,000 <sup>(3)</sup>	—	—	times
—	Byte programming time		—	150	—	μs
—	Block erase time		—	0.05	1	s
t <sub>d</sub> (SR-SUS)	Time delay from suspend request until suspend		—	—	0.25 + CPU clock × 3 cycles	ms
—	Time from suspend until erase restart		—	—	30 + CPU clock × 1 cycle	μs
t <sub>d</sub> (CMDRST-READY)	Time from when command is forcibly stopped until reading is enabled		—	—	30 + CPU clock × 1 cycle	μs
—	Program/erase voltage		1.8	—	5.5	V
—	Read voltage		1.8	—	5.5	V
—	Program/erase temperature		-20 (N version)	—	85	°C
			-40 (D version)	—	85	°C
—	Data hold time <sup>(7)</sup>	Ambient temperature = 85 °C	10	—	—	years

**Notes:**

- V<sub>cc</sub> = 2.7 V to 5.5 V and T<sub>opr</sub> = -20 °C to 85 °C (N version)/-40 °C to 85 °C (D version), unless otherwise specified.
- Definition of program/erase endurance  
The number of program/erase cycles is defined on a per-block basis.  
If the number of cycles is 10,000, each block can be erased 10,000 times.  
For example, if 1,024 cycles of 1-byte-write are performed to different addresses in 1 Kbyte of block A, and then the block is erased, the number of cycles is counted as one. Note, however, that the same address must not be programmed more than once before completion of an erase (overwriting prohibited).
- This indicates the number of times up to which all electrical characteristics can be guaranteed after the last programming/erase operation. Operation is guaranteed for any number of operations in the range of 1 to the specified minimum (Min).
- In a system that executes multiple program operations, the actual erase count can be reduced by shifting the write addresses in sequence and programming so that as much of the flash memory as possible is used before performing an erase operation. For example, when programming in 16-byte units, the effective number of rewrites can be minimized by programming up to 128 units before erasing them all in one operation. It is also advisable to retain data on the number of erase operations for each block and establish a limit for the number of erase operations performed.
- If an error occurs during a block erase, execute a clear status register command and then a block erase command at least three times until the erase error does not occur.
- For information on the program/erase failure rate, contact a Renesas technical support representative.
- The data hold time includes the time that the power supply is off and the time the clock is not supplied.

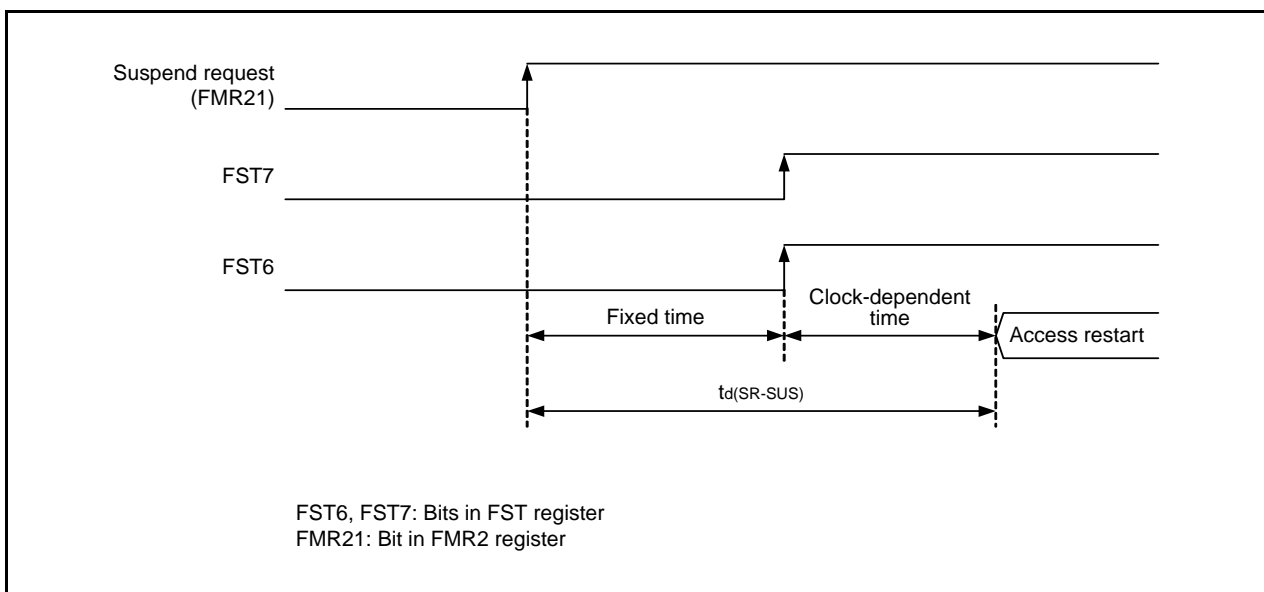
**Figure 4.2 Transition Time until Suspend**

**Table 4.7 Voltage Detection 0 Circuit Electrical Characteristics**

Symbol	Parameter	Condition	Standard			Unit
			Min.	Typ.	Max.	
Vdet0	Voltage detection level Vdet0_0 <sup>(2)</sup>		1.80	1.90	2.05	V
	Voltage detection level Vdet0_1 <sup>(2)</sup>		2.15	2.35	2.50	V
	Voltage detection level Vdet0_2 <sup>(2)</sup>		2.70	2.85	3.05	V
	Voltage detection level Vdet0_3 <sup>(2)</sup>		3.55	3.80	4.05	V
—	Voltage detection 0 circuit response time <sup>(3)</sup>	When Vcc decreases from 5 V to (Vdet0_0 - 0.1) V	—	30	—	μs
—	Self power consumption in voltage detection circuit	VC0E = 1, Vcc = 5.0 V	—	1.5	—	μA
td(E-A)	Wait time until voltage detection circuit operation starts <sup>(4)</sup>		—	—	100	μs

Notes:

1. The measurement condition is Vcc = 1.8 V to 5.5 V and Topr = -20 °C to 85 °C (N version)/-40 °C to 85 °C (D version).
2. Select the voltage detection level with bits VDSEL0 and VDSEL1 in the OFS register.
3. The response time is from when the voltage passes Vdet0 until the voltage monitor 0 reset is generated.
4. The wait time is necessary for the voltage detection circuit to operate when the VC0E bit in the VCA2 register is set to 0 and then 1.

**Table 4.8 Voltage Detection 1 Circuit Electrical Characteristics**

Symbol	Parameter	Condition	Standard			Unit
			Min.	Typ.	Max.	
Vdet1	Voltage detection level Vdet1_1 <sup>(2)</sup>	When Vcc decreases	2.15	2.35	2.55	V
	Voltage detection level Vdet1_3 <sup>(2)</sup>	When Vcc decreases	2.45	2.65	2.85	V
	Voltage detection level Vdet1_5 <sup>(2)</sup>	When Vcc decreases	2.75	2.95	3.15	V
	Voltage detection level Vdet1_7 <sup>(2)</sup>	When Vcc decreases	3.00	3.25	3.55	V
	Voltage detection level Vdet1_9 <sup>(2)</sup>	When Vcc decreases	3.30	3.55	3.85	V
	Voltage detection level Vdet1_B <sup>(2)</sup>	When Vcc decreases	3.60	3.85	4.15	V
	Voltage detection level Vdet1_D <sup>(2)</sup>	When Vcc decreases	3.90	4.15	4.45	V
	Voltage detection level Vdet1_F <sup>(2)</sup>	When Vcc decreases	4.20	4.45	4.75	V
—	Hysteresis width at the rising of Vcc in voltage detection 1 circuit	Vdet1_1 to Vdet1_5 selected	—	0.07	—	V
		Vdet1_7 to Vdet1_F selected	—	0.10	—	V
—	Voltage detection 1 circuit response time <sup>(3)</sup>	When Vcc decreases from 5 V to (Vdet1_0 - 0.1) V	—	60	150	μs
—	Self power consumption in voltage detection circuit	VC1E = 1, Vcc = 5.0 V	—	1.7	—	μA
td(E-A)	Wait time until voltage detection circuit operation starts <sup>(4)</sup>		—	—	100	μs

Notes:

1. The measurement condition is Vcc = 1.8 V to 5.5 V and Topr = -20 °C to 85 °C (N version)/-40 °C to 85 °C (D version).
2. Select the voltage detection level with bits VD1S1 to VD1S3 in the VD1LS register.
3. The response time is from when the voltage passes Vdet1 until the voltage monitor 1 interrupt request is generated.
4. The wait time is necessary for the voltage detection circuit to operate when the VC1E bit in the VCA2 register is set to 0 and then 1.

**Table 4.9 Power-On Reset Circuit (2)**

Symbol	Parameter	Condition	Standard			Unit
			Min.	Typ.	Max.	
$t_{rth}$	External power Vcc rise gradient		0	—	50,000	mV/msec

Notes:

1. The measurement condition is  $T_{opr} = -20\text{ }^{\circ}\text{C}$  to  $85\text{ }^{\circ}\text{C}$  (N version)/ $-40\text{ }^{\circ}\text{C}$  to  $85\text{ }^{\circ}\text{C}$  (D version), unless otherwise specified.
2. To use the power-on reset function, enable the voltage monitor 0 reset by setting the LVDAS bit in the OFS register to 0.

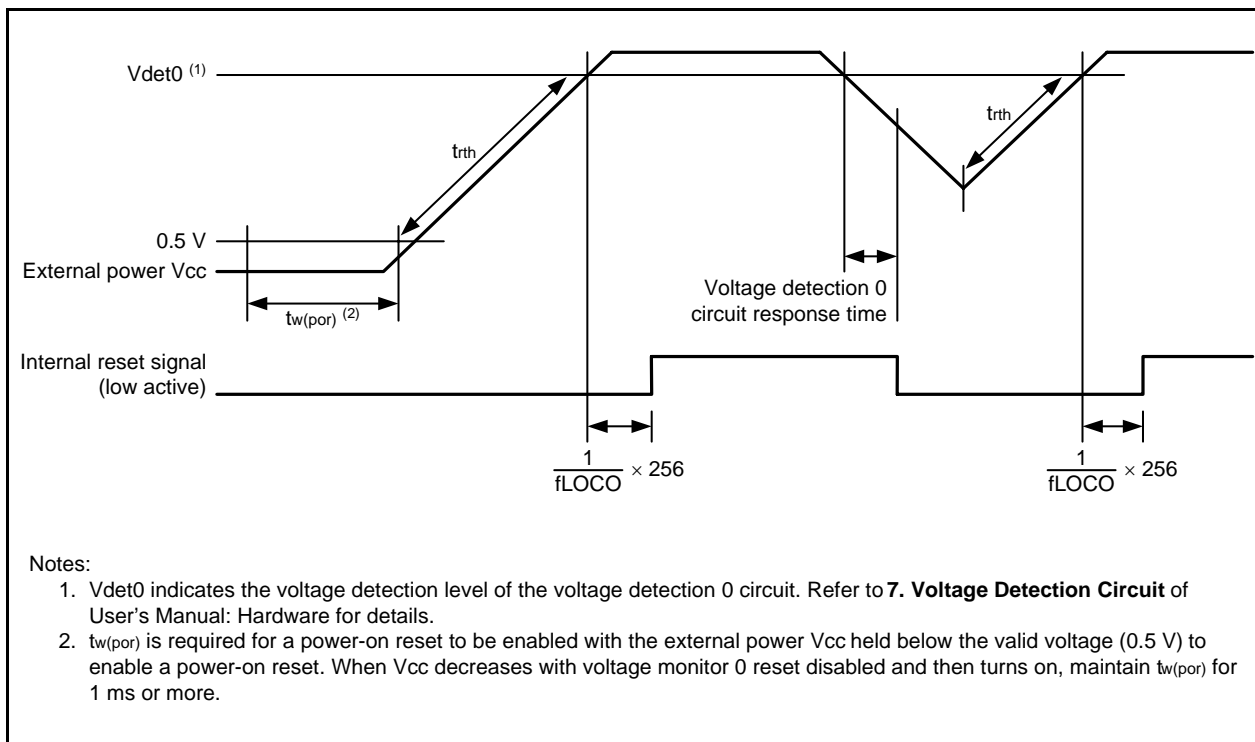
**Figure 4.3 Power-On Reset Circuit Electrical Characteristics**

**Table 4.10 High-Speed On-Chip Oscillator Circuit Electrical Characteristics**

Symbol	Parameter	Condition	Standard			Unit
			Min.	Typ.	Max.	
—	High-speed on-chip oscillator frequency after reset is cleared	$V_{CC} = 1.8 \text{ V to } 5.5 \text{ V}, -20 \text{ }^\circ\text{C} \leq T_{opr} \leq 85 \text{ }^\circ\text{C}$	19.2	20.0	20.8	MHz
		$V_{CC} = 1.8 \text{ V to } 5.5 \text{ V}, -40 \text{ }^\circ\text{C} \leq T_{opr} \leq 85 \text{ }^\circ\text{C}$	19.0	20.0	21.0	MHz
—	High-speed on-chip oscillator frequency when the FR18S0 register adjustment value is written into the FRV1 register and the FR18S1 register adjustment value into the FRV2 register <sup>(2)</sup>	$V_{CC} = 1.8 \text{ V to } 5.5 \text{ V}, -20 \text{ }^\circ\text{C} \leq T_{opr} \leq 85 \text{ }^\circ\text{C}$	17.694	18.432	19.169	MHz
		$V_{CC} = 1.8 \text{ V to } 5.5 \text{ V}, -40 \text{ }^\circ\text{C} \leq T_{opr} \leq 85 \text{ }^\circ\text{C}$	17.510	18.432	19.353	MHz
—	Oscillation stabilization time		—	—	30	$\mu\text{s}$
—	Self power consumption at oscillation	$V_{CC} = 5.0 \text{ V}, T_{opr} = 25 \text{ }^\circ\text{C}$	—	530	—	$\mu\text{A}$

Notes:

- $V_{CC} = 1.8 \text{ V to } 5.5 \text{ V}, T_{opr} = -20 \text{ }^\circ\text{C to } 85 \text{ }^\circ\text{C}$  (N version)/ $-40 \text{ }^\circ\text{C to } 85 \text{ }^\circ\text{C}$  (D version), unless otherwise specified.
- This enables the setting errors of bit rates such as 9600 bps and 38400 bps to be 0% when the serial interface is used in UART mode.

**Table 4.11 Low-Speed On-Chip Oscillator Circuit Electrical Characteristics**

Symbol	Parameter	Condition	Standard			Unit
			Min.	Typ.	Max.	
fLCO	Low-speed on-chip oscillator frequency		60	125	250	kHz
—	Oscillation stabilization time		—	—	35	$\mu\text{s}$
—	Self power consumption at oscillation	$V_{CC} = 5.0 \text{ V}, T_{opr} = 25 \text{ }^\circ\text{C}$	—	2	—	$\mu\text{A}$

Note:

- $V_{CC} = 1.8 \text{ V to } 5.5 \text{ V}, T_{opr} = -20 \text{ }^\circ\text{C to } 85 \text{ }^\circ\text{C}$  (N version)/ $-40 \text{ }^\circ\text{C to } 85 \text{ }^\circ\text{C}$  (D version), unless otherwise specified.

**Table 4.12 Power Supply Circuit Timing Characteristics**

Symbol	Parameter	Condition	Standard			Unit
			Min.	Typ.	Max.	
t <sub>d(P-R)</sub>	Time for internal power supply stabilization during power-on <sup>(2)</sup>		—	—	2,000	$\mu\text{s}$

Notes:

- The measurement condition is  $V_{CC} = 1.8 \text{ V to } 5.5 \text{ V}$  and  $T_{opr} = 25 \text{ }^\circ\text{C}$ .
- Wait time until the internal power supply generation circuit stabilizes during power-on.

**Table 4.13 Timing Requirements of Synchronous Serial Communication Unit (SSU)**

Symbol	Parameter		Condition	Standard			Unit
				Min.	Typ.	Max.	
tSUCYC	SSCK clock cycle time			4	—	—	tCYC <sup>(2)</sup>
tHI	SSCK clock high width			0.4	—	0.6	tSUCYC
tLO	SSCK clock low width			0.4	—	0.6	tSUCYC
tRISE	SSCK clock rising time	Master		—	—	1	tCYC <sup>(2)</sup>
		Slave		—	—	1	μs
tFALL	SSCK clock falling time	Master		—	—	1	tCYC <sup>(2)</sup>
		Slave		—	—	1	μs
tSU	SSO, SSI data input setup time			100	—	—	ns
tH	SSO, SSI data input hold time			1	—	—	tCYC <sup>(2)</sup>
tLEAD	SCS setup time	Slave		1 tCYC + 50	—	—	ns
tLAG	SCS hold time	Slave		1 tCYC + 50	—	—	ns
tOD	SSO, SSI data output delay time			—	—	1	tCYC <sup>(2)</sup>
tSA	SSI slave access time		2.7 V ≤ V <sub>CC</sub> ≤ 5.5 V	—	—	1.5 tCYC + 100	ns
			1.8 V ≤ V <sub>CC</sub> < 2.7 V	—	—	1.5 tCYC + 200	ns
tOR	SSI slave out open time		2.7 V ≤ V <sub>CC</sub> ≤ 5.5 V	—	—	1.5 tCYC + 100	ns
			1.8 V ≤ V <sub>CC</sub> < 2.7 V	—	—	1.5 tCYC + 200	ns

Notes:

1. V<sub>CC</sub> = 1.8 V to 5.5 V, V<sub>SS</sub> = 0 V, and Topr = -20 °C to 85 °C (N version)/-40 °C to 85 °C (D version), unless otherwise specified.
2. 1 tCYC = 1/f<sub>1</sub> (s)

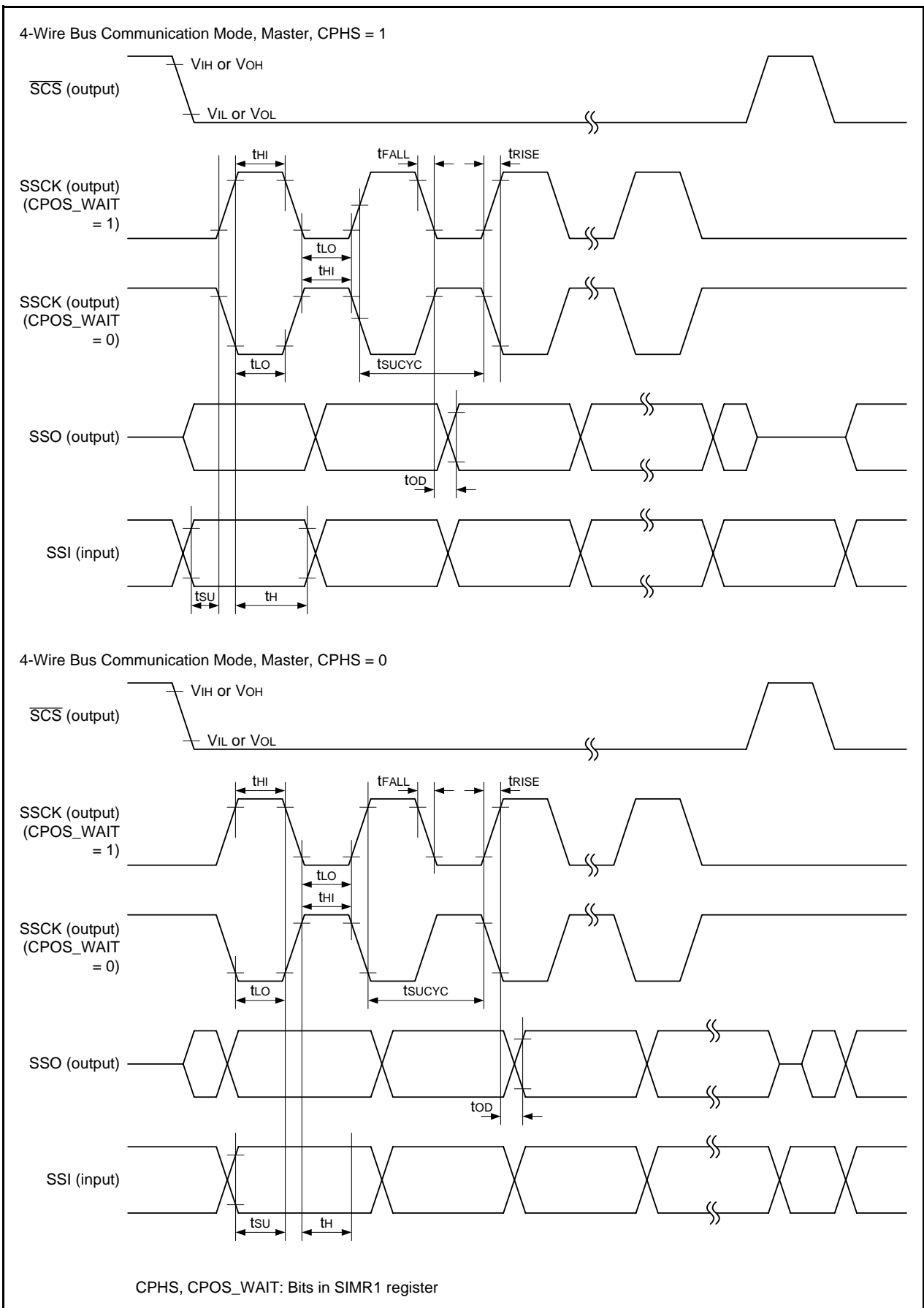

Figure 4.4 I/O Timing of Synchronous Serial Communication Unit (SSU) (Master)



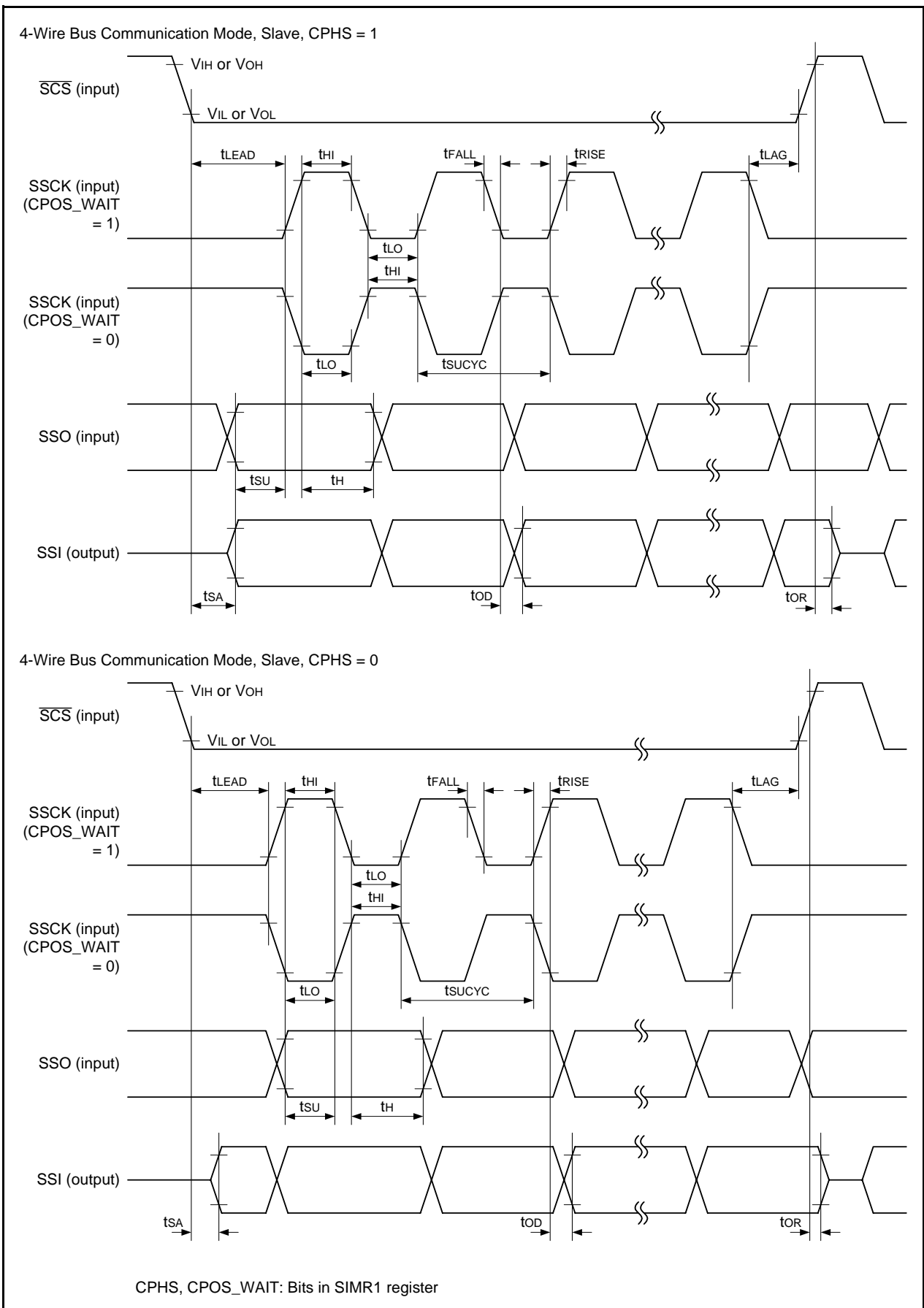
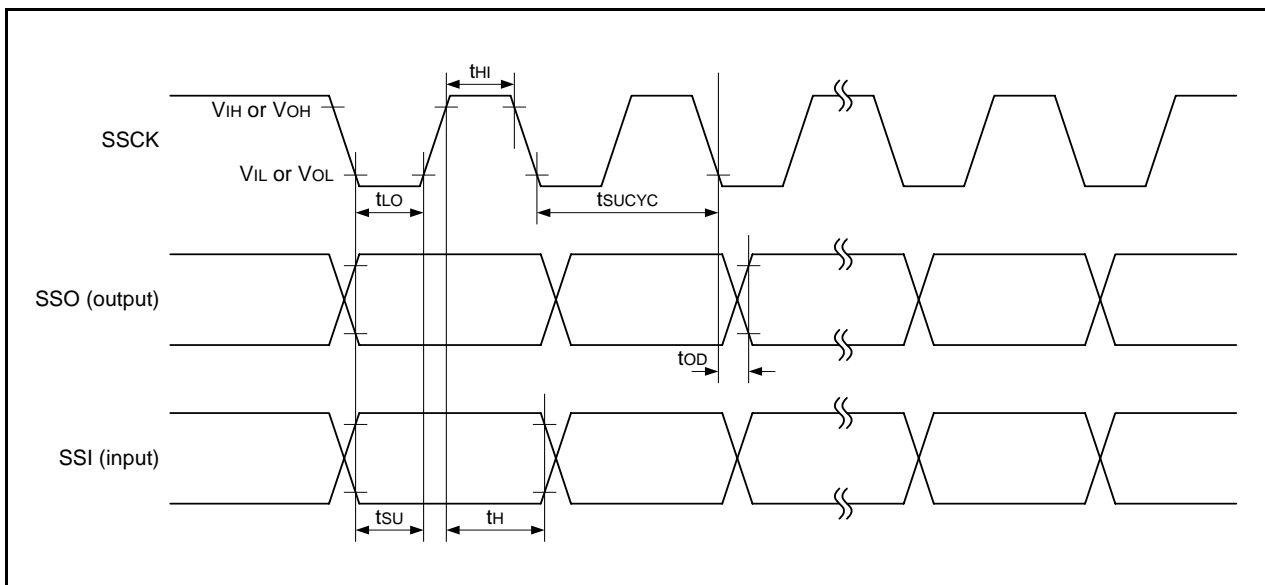

Figure 4.5 I/O Timing of Synchronous Serial Communication Unit (SSU) (Slave)



**Figure 4.6 I/O Timing of Synchronous Serial Communication Unit (SSU) (Clock Synchronous Communication Mode)**

**Table 4.14 Timing Requirements of I<sup>2</sup>C bus Interface**

Symbol	Parameter	Condition	Standard			Unit
			Min.	Typ.	Max.	
t <sub>SCL</sub>	SCL input cycle time		12 t <sub>cyc</sub> + 600 <sup>(2)</sup>	—	—	ns
t <sub>SCLH</sub>	SCL input high width		3 t <sub>cyc</sub> + 300 <sup>(2)</sup>	—	—	ns
t <sub>SCLL</sub>	SCL input low width		5 t <sub>cyc</sub> + 500 <sup>(2)</sup>	—	—	ns
t <sub>sf</sub>	SCL, SDA input fall time		—	—	300	ns
t <sub>SP</sub>	SCL, SDA input spike pulse rejection time		—	—	1 t <sub>cyc</sub> <sup>(2)</sup>	ns
t <sub>BUF</sub>	SDA input bus-free time		5 t <sub>cyc</sub> <sup>(2)</sup>	—	—	ns
t <sub>STAH</sub>	Start condition input hold time		3 t <sub>cyc</sub> <sup>(2)</sup>	—	—	ns
t <sub>STAS</sub>	Retransmit start condition input setup time		3 t <sub>cyc</sub> <sup>(2)</sup>	—	—	ns
t <sub>STOP</sub>	Stop condition input setup time		3 t <sub>cyc</sub> <sup>(2)</sup>	—	—	ns
t <sub>SDAS</sub>	Data input setup time		1 t <sub>cyc</sub> + 40 <sup>(2)</sup>	—	—	ns
t <sub>SDAH</sub>	Data input hold time		10	—	—	ns

Notes:

1. V<sub>CC</sub> = 1.8 V to 5.5 V, V<sub>SS</sub> = 0 V, and Topr = -20 °C to 85 °C (N version)/-40 °C to 85 °C (D version), unless otherwise specified.
2. 1 t<sub>cyc</sub> = 1/f<sub>1</sub> (s)

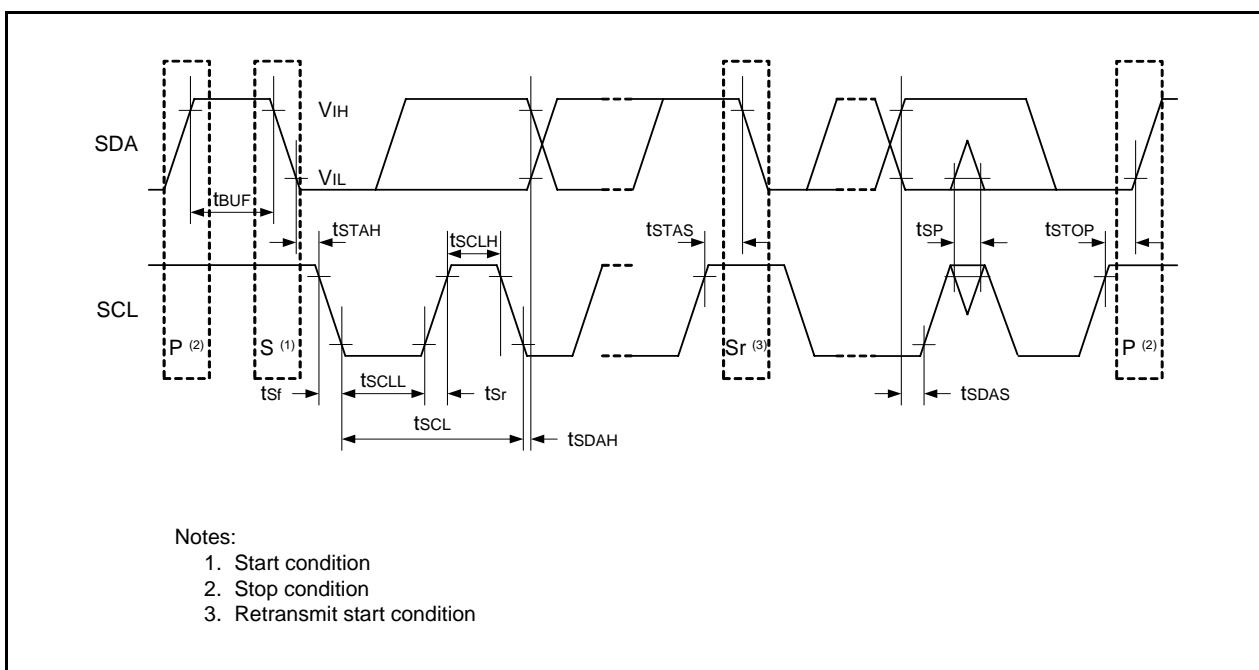

**Figure 4.7 I/O Timing of I<sup>2</sup>C bus Interface**

**Table 4.15 DC Characteristics (1) [4.0 V ≤ Vcc ≤ 5.5 V]**

Symbol	Parameter		Condition		Standard			Unit
					Min.	Typ.	Max.	
VOH	Output high voltage	P1_2, P1_3, P1_4, P1_5, P3_3, P3_4, P3_5, P3_7 (2)	When drive capacity is high	IOH = -20 mA	Vcc - 2.0	—	Vcc	V
			When drive capacity is low	IOH = -5 mA	Vcc - 2.0	—	Vcc	V
		P0_0, P0_1, P0_2, P0_3, P0_4, P0_5, P0_6, P0_7, P1_0, P1_1, P1_6, P1_7, P2_0, P2_1, P2_2, P3_1, P4_2, P4_5, P4_6, P4_7, PA_0		IOH = -5 mA	Vcc - 2.0	—	Vcc	V
VOL	Output low voltage	P1_2, P1_3, P1_4, P1_5, P3_3, P3_4, P3_5, P3_7 (2)	When drive capacity is high	IOL = 20 mA	—	—	2.0	V
			When drive capacity is low	IOL = 5 mA	—	—	2.0	V
		P0_0, P0_1, P0_2, P0_3, P0_4, P0_5, P0_6, P0_7, P1_0, P1_1, P1_6, P1_7, P2_0, P2_1, P2_2, P3_1, P4_2, P4_5, P4_6, P4_7, PA_0		IOL = 5 mA	—	—	2.0	V
VT+-VT-	Hysteresis	INT0, INT1, INT2, INT3, KI0, KI1, KI2, KI3, TRJIO, TRCIOA, TRCIOB, TRCIOC, TRCIOD, RXD0, CLK0	Vcc = 5 V		0.1	1.2	—	V
		RESET	Vcc = 5 V		0.1	1.2	—	V
IiH	Input high current		Vi = 5 V, Vcc = 5.0 V		—	—	5.0	μA
IiL	Input low current		Vi = 0 V, Vcc = 5.0 V		—	—	-5.0	μA
RPULLUP	Pull-up resistance		Vi = 0 V, Vcc = 5.0 V		25	50	100	kΩ
RixIN	Feedback resistance	XIN			—	2.2	—	MΩ
RixCIN	Feedback resistance	XCIN			—	14	—	MΩ
VRAM	RAM hold voltage		In stop mode		1.8	—	—	V

## Notes:

- 4.0 V ≤ Vcc ≤ 5.5 V and Topr = -20 °C to 85 °C (N version)/-40 °C to 85 °C (D version), f(XIN) = 20 MHz, unless otherwise specified.
- High drive capacity can also be used while the peripheral output function is used.

**Table 4.16 DC Characteristics (2) [4.0 V ≤ V<sub>CC</sub> ≤ 5.5 V]  
(Topr = -20 °C to 85 °C (N version)/-40 °C to 85 °C (D version), unless otherwise specified)**

Symbol	Parameter	Condition	Condition										Unit
			Oscillation Circuit		On-Chip Oscillator		CPU Clock	Low-Power-Consumption Setting	Other	Standard			
			XIN (2)	XCIN	High-Speed	Low-Speed				Min.	Typ. (3)	Max.	
I <sub>CC</sub>	Power supply current (1)	High-speed clock mode	20 MHz	Off	Off	125 kHz	No division	—		—	3.5	7.0	mA
			16 MHz	Off	Off	125 kHz	No division	—		—	2.8	6.0	mA
			10 MHz	Off	Off	125 kHz	No division	—		—	1.8	—	mA
			20 MHz	Off	Off	125 kHz	Division by 8	—		—	2.0	—	mA
			16 MHz	Off	Off	125 kHz	Division by 8	—		—	1.7	—	mA
			10 MHz	Off	Off	125 kHz	Division by 8	—		—	1.1	—	mA
		High-speed on-chip oscillator mode	Off	Off	20 MHz	125 kHz	No division			—	4.0	7.5	mA
			Off	Off	20 MHz	125 kHz	Division by 8			—	2.5	—	mA
			Off	Off	4 MHz (4)	125 kHz	Division by 16	MSTTRC = 1		—	1.0	—	mA
		Low-speed on-chip oscillator mode	Off	Off	Off	125 kHz	Division by 8	FMR27 = 1 LPE = 0		—	70	270	μA
		Low-speed clock mode	Off	32 kHz	Off	Off	—	FMR27 = 1 LPE = 0		—	65	270	μA
			Off	32 kHz	Off	Off	—	FMSTP = 1 LPE = 0	Flash memory stopped during program operation in RAM	—	45	—	μA
		Wait mode	Off	Off	Off	125 kHz	—	VC1E = 0 VC0E = 0 LPE = 1	Peripheral clock supplied during WAIT instruction execution	—	15	100	μA
			Off	Off	Off	125 kHz	—	VC1E = 0 VC0E = 0 LPE = 1 WCKSTP = 1	Peripheral clock stopped during WAIT instruction execution	—	5.0	90	μA
			Off	32 kHz	Off	Off	—	VC1E = 0 VC0E = 0 LPE = 1 WCKSTP = 1	Peripheral clock stopped during WAIT instruction execution	—	3.5	—	μA
		Stop mode	Off	Off	Off	Off	—	VC1E = 0 VC0E = 0 STPM = 1	Topr = 25 °C Peripheral clock stopped	—	1.0	4.0	μA
			Off	Off	Off	Off	—	VC1E = 0 VC0E = 0 STPM = 1	Topr = 85 °C Peripheral clock stopped	—	1.9	—	μA

## Notes:

1. V<sub>CC</sub> = 4.0 V to 5.5 V, single-chip mode, output pins are open, and other pins are connected to V<sub>SS</sub>.
2. When the XIN input is a square wave.
3. V<sub>CC</sub> = 5.0 V
4. Set the system clock to 4 MHz with the PHISEL register.

Timing Requirements ( $V_{CC} = 5\text{ V}$ ,  $V_{SS} = 0\text{ V}$  at  $T_{op} = 25\text{ }^{\circ}\text{C}$ , unless otherwise specified) [ $V_{CC} = 5\text{ V}$ ]

**Table 4.17 External Clock Input (XIN, XCIN)**

Symbol	Parameter	Standard		Unit
		Min.	Max.	
$t_{c(XIN)}$	XIN input cycle time	50	—	ns
$t_{WH(XIN)}$	XIN input high width	24	—	ns
$t_{WL(XIN)}$	XIN input low width	24	—	ns
$t_{c(XCIN)}$	XCIN input cycle time	20	—	$\mu\text{s}$
$t_{WH(XCIN)}$	XCIN input high width	10	—	$\mu\text{s}$
$t_{WL(XCIN)}$	XCIN input low width	10	—	$\mu\text{s}$

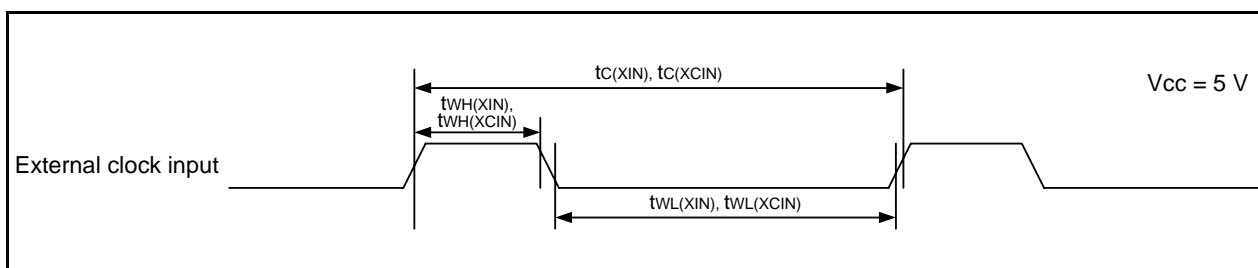

**Figure 4.8 External Clock Input Timing Diagram When  $V_{CC} = 5\text{ V}$**

**Table 4.18 TRJIO Input**

Symbol	Parameter	Standard		Unit
		Min.	Max.	
$t_{c(TRJIO)}$	TRJIO input cycle time	100	—	ns
$t_{WH(TRJIO)}$	TRJIO input high width	40	—	ns
$t_{WL(TRJIO)}$	TRJIO input low width	40	—	ns

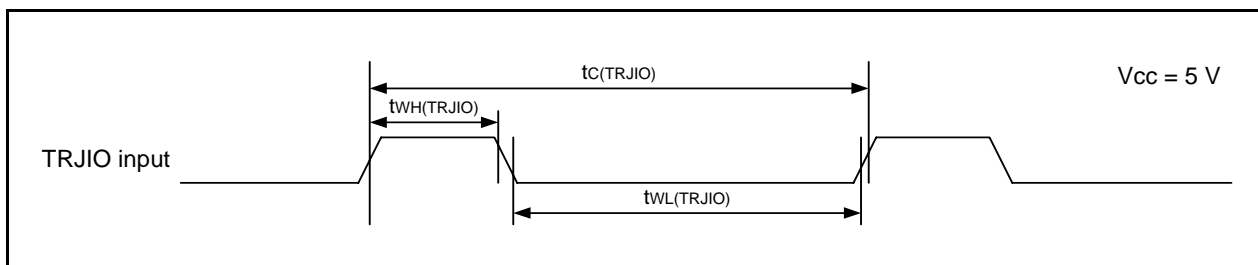
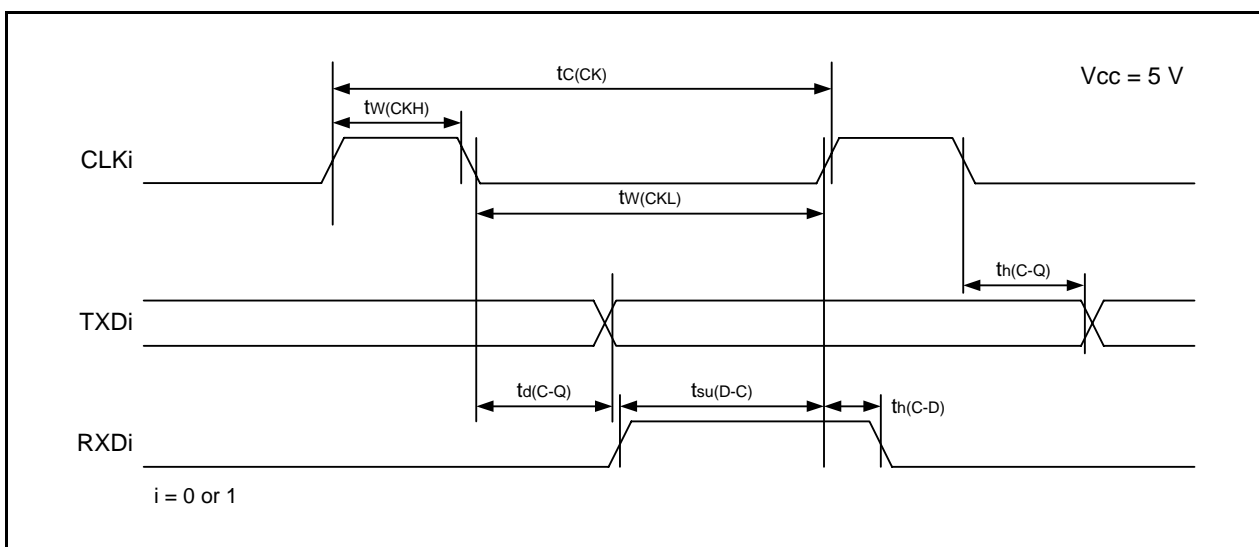

**Figure 4.9 TRJIO Input Timing When  $V_{CC} = 5\text{ V}$**

**Table 4.19 Serial Interface**

Symbol	Parameter	Standard		Unit
		Min.	Max.	
$t_{c(CK)}$	CLKi input cycle time	200	—	ns
$t_{w(CKH)}$	CLKi input high width	100	—	ns
$t_{w(CKL)}$	CLKi input low width	100	—	ns
$t_{d(C-Q)}$	TXDi output delay time	—	50	ns
$t_{h(C-Q)}$	TXDi hold time	0	—	ns
$t_{su(D-C)}$	RXDi input setup time	50	—	ns
$t_{h(C-D)}$	RXDi input hold time	90	—	ns

$i = 0$  or  $1$



**Figure 4.10 Serial Interface Timing When  $V_{cc} = 5\text{ V}$**

**Table 4.20 External Interrupt  $\overline{INTi}$  Input, Key Input Interrupt  $\overline{Kli}$  ( $i = 0$  to  $3$ )**

Symbol	Parameter	Standard		Unit
		Min.	Max.	
$t_{w(INH)}$	$\overline{INTi}$ input high width, $\overline{Kli}$ input high width	250 (1)	—	ns
$t_{w(INL)}$	$\overline{INTi}$ input low width, $\overline{Kli}$ input low width	250 (2)	—	ns

Notes:

1. When the digital filter is enabled by the  $\overline{INTi}$  input filter select bit, the  $\overline{INTi}$  input high width is  $(1/\text{digital filter clock frequency} \times 3)$  or the minimum value of the standard, whichever is greater.
2. When the digital filter is enabled by the  $\overline{INTi}$  input filter select bit, the  $\overline{INTi}$  input low width is  $(1/\text{digital filter clock frequency} \times 3)$  or the minimum value of the standard, whichever is greater.

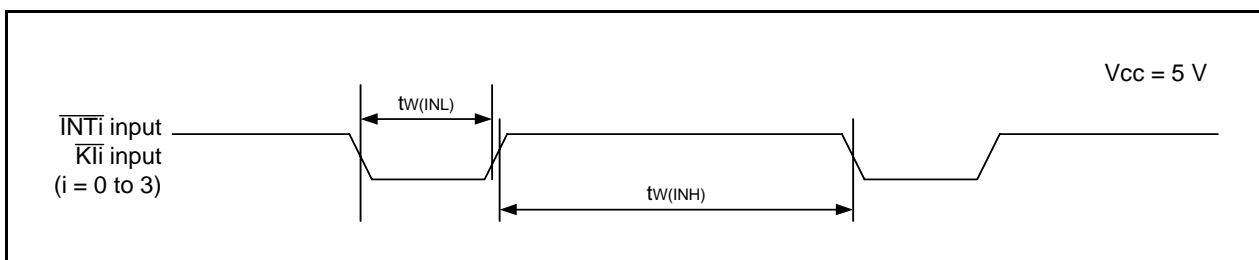

**Figure 4.11 Timing for External Interrupt  $\overline{INTi}$  Input and Key Input Interrupt  $\overline{Kli}$  When  $V_{cc} = 5\text{ V}$**

**Table 4.21 DC Characteristics (3) [ $2.7\text{ V} \leq V_{CC} < 4.0\text{ V}$ ]**

Symbol	Parameter		Condition		Standard			Unit
					Min.	Typ.	Max.	
V <sub>OH</sub>	Output high voltage	P1_2, P1_3, P1_4, P1_5, P3_3, P3_4, P3_5, P3_7 (2)	When drive capacity is high	I <sub>OH</sub> = -5 mA	V <sub>CC</sub> - 0.5	—	V <sub>CC</sub>	V
			When drive capacity is low	I <sub>OH</sub> = -1 mA	V <sub>CC</sub> - 0.5	—	V <sub>CC</sub>	V
		P0_0, P0_1, P0_2, P0_3, P0_4, P0_5, P0_6, P0_7, P1_0, P1_1, P1_6, P1_7, P2_0, P2_1, P2_2, P3_1, P4_2, P4_5, P4_6, P4_7, PA_0		I <sub>OH</sub> = -1 mA	V <sub>CC</sub> - 0.5	—	V <sub>CC</sub>	V
V <sub>OL</sub>	Output low voltage	P1_2, P1_3, P1_4, P1_5, P3_3, P3_4, P3_5, P3_7 (2)	When drive capacity is high	I <sub>OL</sub> = 5 mA	—	—	0.5	V
			When drive capacity is low	I <sub>OL</sub> = 1 mA	—	—	0.5	V
		P0_0, P0_1, P0_2, P0_3, P0_4, P0_5, P0_6, P0_7, P1_0, P1_1, P1_6, P1_7, P2_0, P2_1, P2_2, P3_1, P4_2, P4_5, P4_6, P4_7, PA_0		I <sub>OL</sub> = 1 mA	—	—	0.5	V
V <sub>T+</sub> -V <sub>T-</sub>	Hysteresis	INT0, INT1, INT2, INT3, KI0, KI1, KI2, KI3, TRJIO, TRCIOA, TRCIOB, TRCIOC, TRCIOD, RXD0, CLK0	V <sub>CC</sub> = 3 V		0.1	0.4	—	V
		RESET	V <sub>CC</sub> = 3 V		0.1	0.5	—	V
I <sub>IH</sub>	Input high current		V <sub>I</sub> = 3 V, V <sub>CC</sub> = 3.0 V		—	—	4.0	μA
I <sub>IL</sub>	Input low current		V <sub>I</sub> = 0 V, V <sub>CC</sub> = 3.0 V		—	—	-4.0	μA
R <sub>PULLUP</sub>	Pull-up resistance		V <sub>I</sub> = 0 V, V <sub>CC</sub> = 3.0 V		42	84	168	kΩ
R <sub>iXIN</sub>	Feedback resistance	XIN			—	2.2	—	MΩ
R <sub>iXCIN</sub>	Feedback resistance	XCIN			—	14	—	MΩ
V <sub>RAM</sub>	RAM hold voltage		In stop mode		1.8	—	—	V

## Notes:

1.  $2.7\text{ V} \leq V_{CC} < 4.0\text{ V}$  and Topr = -20 °C to 85 °C (N version)/-40 °C to 85 °C (D version), f(XIN) = 10 MHz, unless otherwise specified.
2. High drive capacity can also be used while the peripheral output function is used.



**Table 4.22 DC Characteristics (4) [2.7 V ≤ Vcc < 4.0 V]  
(Topr = -20 °C to 85 °C (N version)/-40 °C to 85 °C (D version), unless otherwise specified)**

Symbol	Parameter		Condition										Unit
			Oscillation Circuit		On-Chip Oscillator		CPU Clock	Low-Power-Consumption Setting	Other	Standard			
			XIN (2)	XCIN	High-Speed	Low-Speed				Min.	Typ. (3)	Max.	
Icc	Power supply current (1)	High-speed clock mode	20 MHz	Off	Off	125 kHz	No division	—		—	3.5	7.0	mA
			16 MHz	Off	Off	125 kHz	No division	—		—	2.7	6.0	mA
			10 MHz	Off	Off	125 kHz	No division	—		—	1.7	5.0	mA
			20 MHz	Off	Off	125 kHz	Division by 8	—		—	1.9	—	mA
			16 MHz	Off	Off	125 kHz	Division by 8	—		—	1.6	—	mA
			10 MHz	Off	Off	125 kHz	Division by 8	—		—	1.0	4.5	mA
		High-speed on-chip oscillator mode	Off	Off	20 MHz	125 kHz	No division			—	3.9	7.5	mA
			Off	Off	20 MHz	125 kHz	Division by 8			—	2.5	—	mA
			Off	Off	10 MHz (4)	125 kHz	No division			—	2.4	—	mA
			Off	Off	10 MHz (4)	125 kHz	Division by 8			—	1.6	—	mA
			Off	Off	4 MHz (4)	125 kHz	Division by 16	MSTTRC = 1		—	1.0	—	mA
		Low-speed on-chip oscillator mode	Off	Off	Off	125 kHz	Division by 8	FMR27 = 1 LPE = 0		—	60	260	μA
		Low-speed clock mode	Off	32 kHz	Off	Off	—	FMR27 = 1 LPE = 0		—	60	260	μA
			Off	32 kHz	Off	Off	—	FMSTP = 1 LPE = 0	Flash memory stopped during program operation in RAM	—	40	—	μA
		Wait mode	Off	Off	Off	125 kHz	—	VC1E = 0 VC0E = 0 LPE = 1	Peripheral clock supplied during WAIT instruction execution	—	15	90	μA
			Off	Off	Off	125 kHz	—	VC1E = 0 VC0E = 0 LPE = 1 WCKSTP = 1	Peripheral clock stopped during WAIT instruction execution	—	5.0	80	μA
			Off	32 kHz	Off	Off	—	VC1E = 0 VC0E = 0 LPE = 1 WCKSTP = 1	Peripheral clock stopped during WAIT instruction execution	—	3.2	—	μA
		Stop mode	Off	Off	Off	Off	—	VC1E = 0 VC0E = 0 STPM = 1	Topr = 25 °C Peripheral clock stopped	—	1.0	4.0	μA
			Off	Off	Off	Off	—	VC1E = 0 VC0E = 0 STPM = 1	Topr = 85 °C Peripheral clock stopped	—	1.7	—	μA

Notes:

1. Vcc = 2.7 V to 4.0 V, single-chip mode, output pins are open, and other pins are connected to Vss.
2. When the XIN input is a square wave.
3. Vcc = 3.0 V
4. Set the system clock to 10 MHz or 4 MHz with the PHISEL register.

Timing Requirements ( $V_{CC} = 3\text{ V}$ ,  $V_{SS} = 0\text{ V}$  at  $T_{op} = 25\text{ }^{\circ}\text{C}$ , unless otherwise specified) [ $V_{CC} = 3\text{ V}$ ]

**Table 4.23 External Clock Input (XIN, XCIN)**

Symbol	Parameter	Standard		Unit
		Min.	Max.	
$t_{c(XIN)}$	XIN input cycle time	50	—	ns
$t_{WH(XIN)}$	XIN input high width	24	—	ns
$t_{WL(XIN)}$	XIN input low width	24	—	ns
$t_{c(XCIN)}$	XCIN input cycle time	20	—	$\mu\text{s}$
$t_{WH(XCIN)}$	XCIN input high width	10	—	$\mu\text{s}$
$t_{WL(XCIN)}$	XCIN input low width	10	—	$\mu\text{s}$

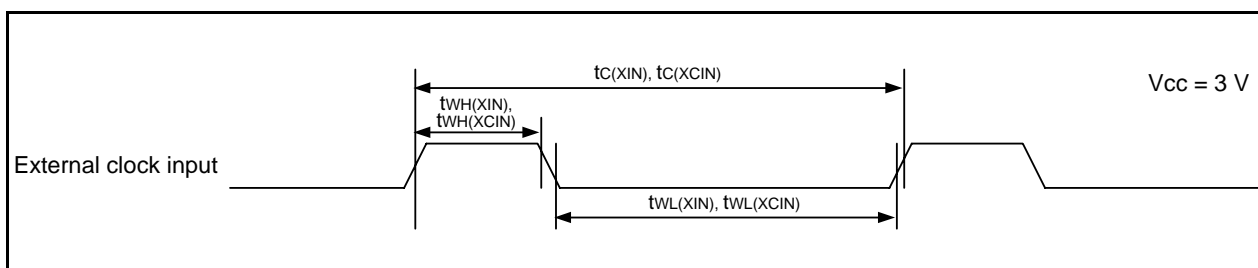

**Figure 4.12 External Clock Input Timing Diagram When  $V_{CC} = 3\text{ V}$**

**Table 4.24 TRJIO Input**

Symbol	Parameter	Standard		Unit
		Min.	Max.	
$t_{c(TRJIO)}$	TRJIO input cycle time	300	—	ns
$t_{WH(TRJIO)}$	TRJIO input high width	120	—	ns
$t_{WL(TRJIO)}$	TRJIO input low width	120	—	ns

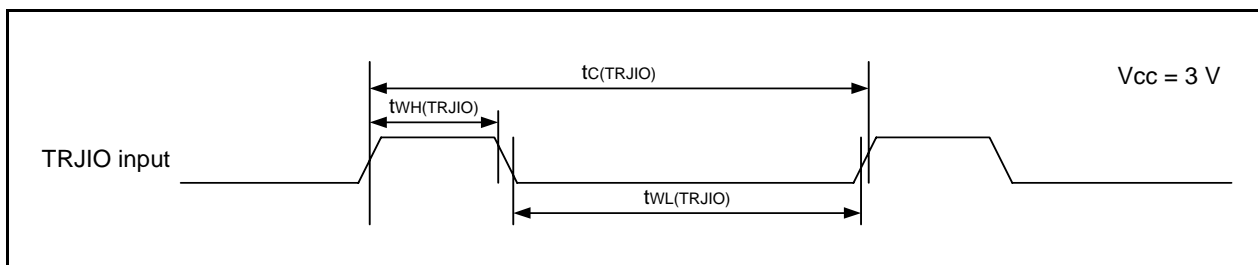
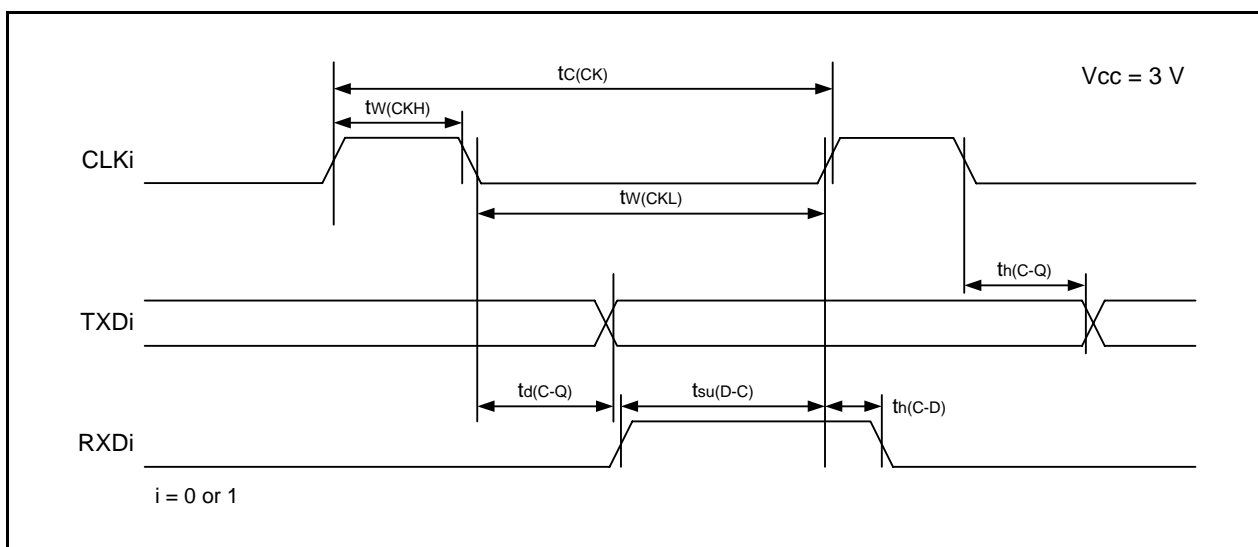

**Figure 4.13 TRJIO Input Timing When  $V_{CC} = 3\text{ V}$**

**Table 4.25 Serial Interface**

Symbol	Parameter	Standard		Unit
		Min.	Max.	
$t_{c(CK)}$	CLKi input cycle time	300	—	ns
$t_{w(CKH)}$	CLKi input high width	150	—	ns
$t_{w(CKL)}$	CLKi input low width	150	—	ns
$t_{d(C-Q)}$	TXDi output delay time	—	80	ns
$t_{h(C-Q)}$	TXDi hold time	0	—	ns
$t_{su(D-C)}$	RXDi input setup time	70	—	ns
$t_{h(C-D)}$	RXDi input hold time	90	—	ns

i = 0 or 1

**Figure 4.14 Serial Interface Timing When Vcc = 3 V****Table 4.26 External Interrupt  $\overline{INTi}$  Input, Key Input Interrupt  $\overline{Kli}$  (i = 0 to 3)**

Symbol	Parameter	Standard		Unit
		Min.	Max.	
$t_{w(INH)}$	$\overline{INTi}$ input high width, $\overline{Kli}$ input high width	380 (1)	—	ns
$t_{w(INL)}$	$\overline{INTi}$ input low width, $\overline{Kli}$ input low width	380 (2)	—	ns

Notes:

- When the digital filter is enabled by the  $\overline{INTi}$  input filter select bit, the  $\overline{INTi}$  input high width is (1/digital filter clock frequency × 3) or the minimum value of the standard, whichever is greater.
- When the digital filter is enabled by the  $\overline{INTi}$  input filter select bit, the  $\overline{INTi}$  input low width is (1/digital filter clock frequency × 3) or the minimum value of the standard, whichever is greater.

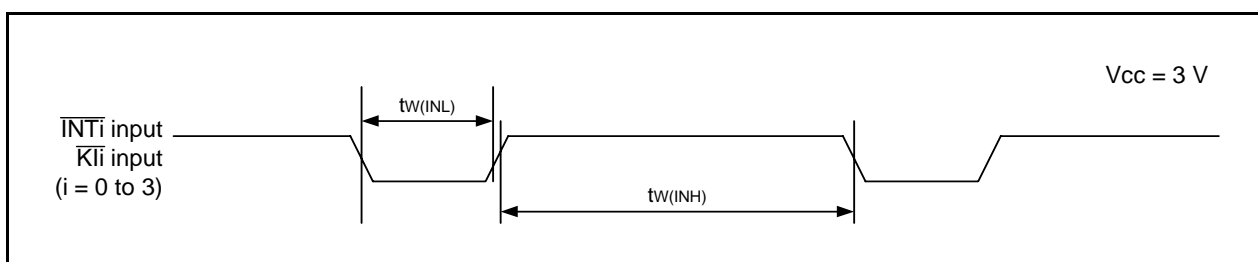
**Figure 4.15 Timing for External Interrupt  $\overline{INTi}$  Input and Key Input Interrupt  $\overline{Kli}$  When Vcc = 3 V**

**Table 4.27 DC Characteristics (5) [ $1.8\text{ V} \leq V_{CC} < 2.7\text{ V}$ ]**

Symbol	Parameter		Condition		Standard			Unit
					Min.	Typ.	Max.	
V <sub>OH</sub>	Output high voltage	P1_2, P1_3, P1_4, P1_5, P3_3, P3_4, P3_5, P3_7 (2)	When drive capacity is high	I <sub>OH</sub> = -2 mA	V <sub>CC</sub> - 0.5	—	V <sub>CC</sub>	V
			When drive capacity is low	I <sub>OH</sub> = -1 mA	V <sub>CC</sub> - 0.5	—	V <sub>CC</sub>	V
		P0_0, P0_1, P0_2, P0_3, P0_4, P0_5, P0_6, P0_7, P1_0, P1_1, P1_6, P1_7, P2_0, P2_1, P2_2, P3_1, P4_2, P4_5, P4_6, P4_7, PA_0		I <sub>OH</sub> = -1 mA	V <sub>CC</sub> - 0.5	—	V <sub>CC</sub>	V
V <sub>OL</sub>	Output low voltage	P1_2, P1_3, P1_4, P1_5, P3_3, P3_4, P3_5, P3_7 (2)	When drive capacity is high	I <sub>OL</sub> = 2 mA	—	—	0.5	V
			When drive capacity is low	I <sub>OL</sub> = 1 mA	—	—	0.5	V
		P0_0, P0_1, P0_2, P0_3, P0_4, P0_5, P0_6, P0_7, P1_0, P1_1, P1_6, P1_7, P2_0, P2_1, P2_2, P3_1, P4_2, P4_5, P4_6, P4_7, PA_0		I <sub>OL</sub> = 1 mA	—	—	0.5	V
V <sub>T+</sub> -V <sub>T-</sub>	Hysteresis	INT0, INT1, INT2, INT3, KI0, KI1, KI2, KI3, TRJIO, TRCIOA, TRCIOB, TRCIOC, TRCIOD, RXD0, CLK0	V <sub>CC</sub> = 2.2 V		0.05	0.20	—	V
		RESET	V <sub>CC</sub> = 2.2 V		0.05	0.20	—	V
I <sub>IH</sub>	Input high current		V <sub>I</sub> = 2.2 V, V <sub>CC</sub> = 2.2 V		—	—	4.0	μA
I <sub>IL</sub>	Input low current		V <sub>I</sub> = 0 V, V <sub>CC</sub> = 2.2 V		—	—	-4.0	μA
R <sub>PULLUP</sub>	Pull-up resistance		V <sub>I</sub> = 0 V, V <sub>CC</sub> = 2.2 V		70	140	300	kΩ
R <sub>iXIN</sub>	Feedback resistance	XIN			—	2.2	—	MΩ
R <sub>iXCIN</sub>	Feedback resistance	XCIN			—	14	—	MΩ
V <sub>RAM</sub>	RAM hold voltage		In stop mode		1.8	—	—	V

## Notes:

1.  $1.8\text{ V} \leq V_{CC} < 2.7\text{ V}$  and Topr = -20 °C to 85 °C (N version)/-40 °C to 85 °C (D version), f(XIN) = 5 MHz, unless otherwise specified.
2. High drive capacity can also be used while the peripheral output function is used.

**Table 4.28 DC Characteristics (6) [1.8 V ≤ V<sub>CC</sub> < 2.7 V]  
(Topr = -20 °C to 85 °C (N version)/-40 °C to 85 °C (D version), unless otherwise specified)**

Symbol	Parameter		Condition										Unit
			Oscillation Circuit		On-Chip Oscillator		CPU Clock	Low-Power-Consumption Setting	Other	Standard			
			XIN (2)	XCIN	High-Speed	Low-Speed				Min.	Typ. (3)	Max.	
I <sub>CC</sub>	Power supply current (1)	High-speed clock mode	5 MHz	Off	Off	125 kHz	No division	—		—	1.1	—	mA
			5 MHz	Off	Off	125 kHz	Division by 8	—		—	0.8	—	mA
	High-speed on-chip oscillator mode	Off	Off	5 MHz (4)	125 kHz	No division			—	1.8	6.5	mA	
		Off	Off	5 MHz (4)	125 kHz	Division by 8			—	1.6	—	mA	
		Off	Off	4 MHz (4)	125 kHz	Division by 16	MSTTRC = 1		—	1.3	—	mA	
	Low-speed on-chip oscillator mode	Off	Off	Off	125 kHz	Division by 8	FMR27 = 1 LPE = 0		—	60	200	μA	
	Low-speed clock mode	Off	32 kHz	Off	Off	—	FMR27 = 1 LPE = 0		—	55	200	μA	
		Off	32 kHz	Off	Off	—	FMSTP = 1 LPE = 0	Flash memory stopped during program operation in RAM	—	30	—	μA	
	Wait mode	Off	Off	Off	125 kHz	—	VC1E = 0 VC0E = 0 LPE = 1	Peripheral clock supplied during WAIT instruction execution	—	15	90	μA	
		Off	Off	Off	125 kHz	—	VC1E = 0 VC0E = 0 LPE = 1 WCKSTP = 1	Peripheral clock stopped during WAIT instruction execution	—	4.5	80	μA	
		Off	32 kHz	Off	Off	—	VC1E = 0 VC0E = 0 LPE = 1 WCKSTP = 1	Peripheral clock stopped during WAIT instruction execution	—	3	—	μA	
	Stop mode	Off	Off	Off	Off	—	VC1E = 0 VC0E = 0 STPM = 1	Topr = 25 °C Peripheral clock stopped	—	1	4.0	μA	
		Off	Off	Off	Off	—	VC1E = 0 VC0E = 0 STPM = 1	Topr = 85 °C Peripheral clock stopped	—	1.6	—	μA	

Notes:

1. V<sub>CC</sub> = 1.8 V to 2.7 V, single-chip mode, output pins are open, and other pins are connected to V<sub>SS</sub>.
2. When the XIN input is a square wave.
3. V<sub>CC</sub> = 2.2 V
4. Set the system clock to 5 MHz or 4 MHz with the PHISEL register.

Timing Requirements ( $V_{CC} = 2.2\text{ V}$ ,  $V_{SS} = 0\text{ V}$  at  $T_{op} = 25\text{ }^{\circ}\text{C}$ , unless otherwise specified) [ $V_{CC} = 2.2\text{ V}$ ]

**Table 4.29 External Clock Input (XIN, XCIN)**

Symbol	Parameter	Standard		Unit
		Min.	Max.	
$t_{c(XIN)}$	XIN input cycle time	200	—	ns
$t_{WH(XIN)}$	XIN input high width	90	—	ns
$t_{WL(XIN)}$	XIN input low width	90	—	ns
$t_{c(XCIN)}$	XCIN input cycle time	20	—	$\mu\text{s}$
$t_{WH(XCIN)}$	XCIN input high width	10	—	$\mu\text{s}$
$t_{WL(XCIN)}$	XCIN input low width	10	—	$\mu\text{s}$

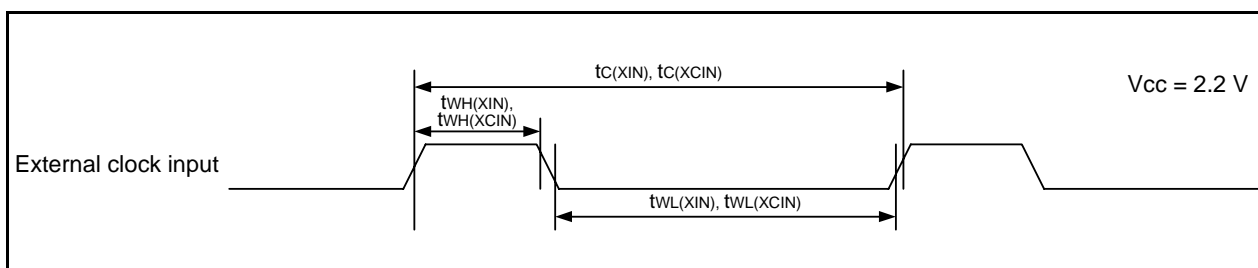

**Figure 4.16 External Clock Input Timing Diagram When  $V_{CC} = 2.2\text{ V}$**

**Table 4.30 TRJIO Input**

Symbol	Parameter	Standard		Unit
		Min.	Max.	
$t_{c(TRJIO)}$	TRJIO input cycle time	500	—	ns
$t_{WH(TRJIO)}$	TRJIO input high width	200	—	ns
$t_{WL(TRJIO)}$	TRJIO input low width	200	—	ns

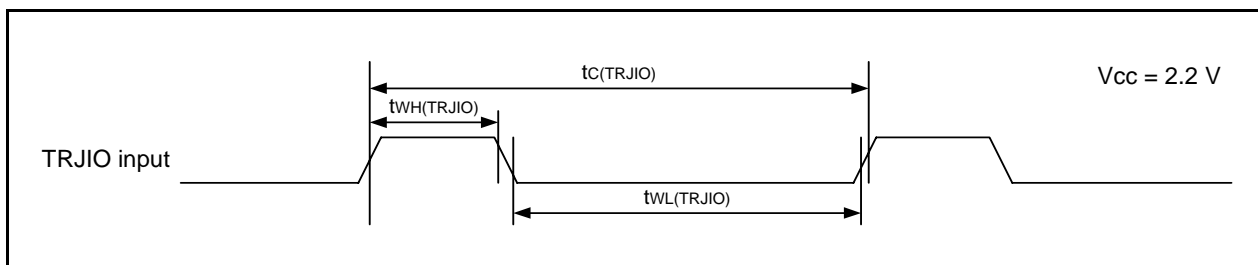
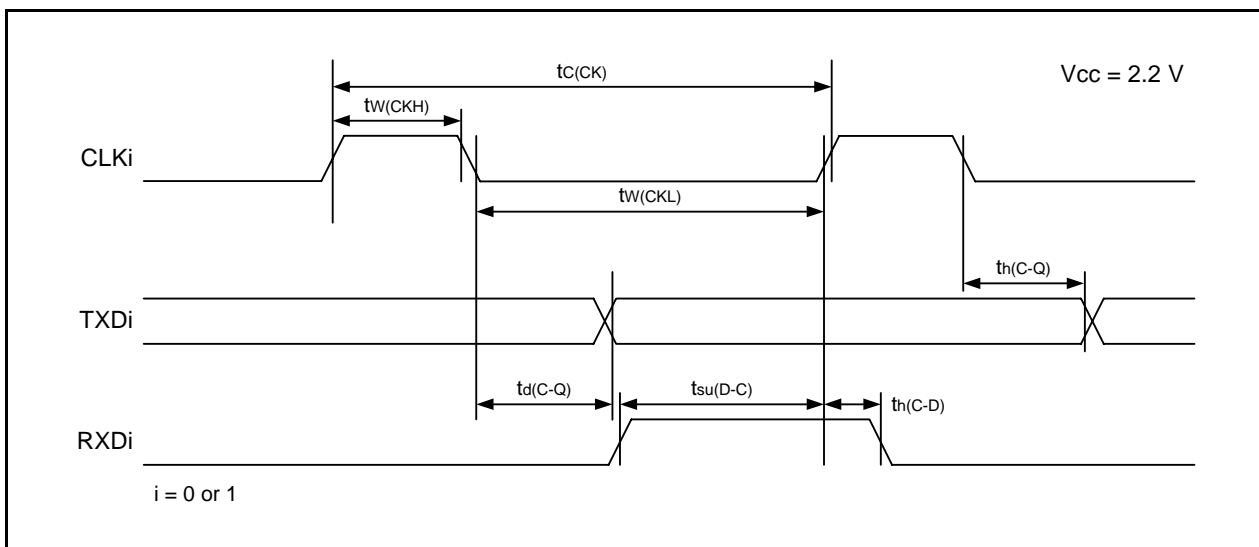

**Figure 4.17 TRJIO Input Timing When  $V_{CC} = 2.2\text{ V}$**

**Table 4.31 Serial Interface**

Symbol	Parameter	Standard		Unit
		Min.	Max.	
$t_{c(CK)}$	CLKi input cycle time	800	—	ns
$t_{w(CKH)}$	CLKi input high width	400	—	ns
$t_{w(CKL)}$	CLKi input low width	400	—	ns
$t_{d(C-Q)}$	TXDi output delay time	—	200	ns
$t_{h(C-Q)}$	TXDi hold time	0	—	ns
$t_{su(D-C)}$	RXDi input setup time	150	—	ns
$t_{h(C-D)}$	RXDi input hold time	90	—	ns

$i = 0$  or  $1$



**Figure 4.18 Serial Interface Timing When  $V_{cc} = 2.2$  V**

**Table 4.32 External Interrupt  $\overline{INTi}$  Input, Key Input Interrupt  $\overline{Kli}$  ( $i = 0$  to  $3$ )**

Symbol	Parameter	Standard		Unit
		Min.	Max.	
$t_{w(INH)}$	$\overline{INTi}$ input high width, $\overline{Kli}$ input high width	1,000 (1)	—	ns
$t_{w(INL)}$	$\overline{INTi}$ input low width, $\overline{Kli}$ input low width	1,000 (2)	—	ns

Notes:

1. When the digital filter is enabled by the  $\overline{INTi}$  input filter select bit, the  $\overline{INTi}$  input high width is  $(1/\text{digital filter clock frequency} \times 3)$  or the minimum value of the standard, whichever is greater.
2. When the digital filter is enabled by the  $\overline{INTi}$  input filter select bit, the  $\overline{INTi}$  input low width is  $(1/\text{digital filter clock frequency} \times 3)$  or the minimum value of the standard, whichever is greater.

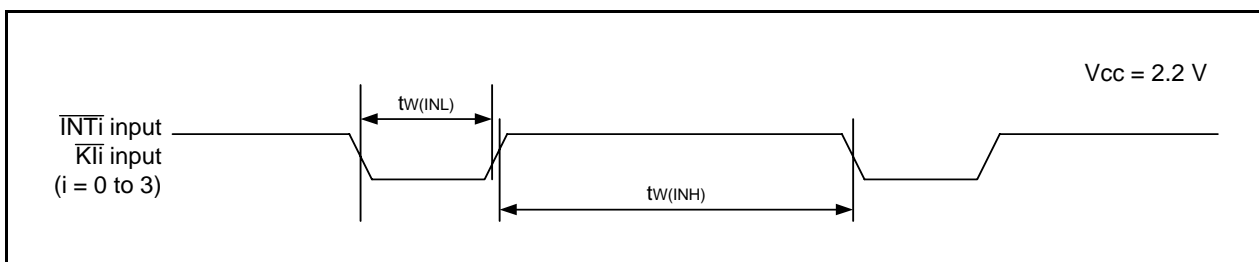

**Figure 4.19 Timing for External Interrupt  $\overline{INTi}$  Input and Key Input Interrupt  $\overline{Kli}$  When  $V_{cc} = 2.2$  V**

# Package Dimensions

Diagrams showing the latest package dimensions and mounting information are available in the “Packages” section of the Renesas Electronics website.

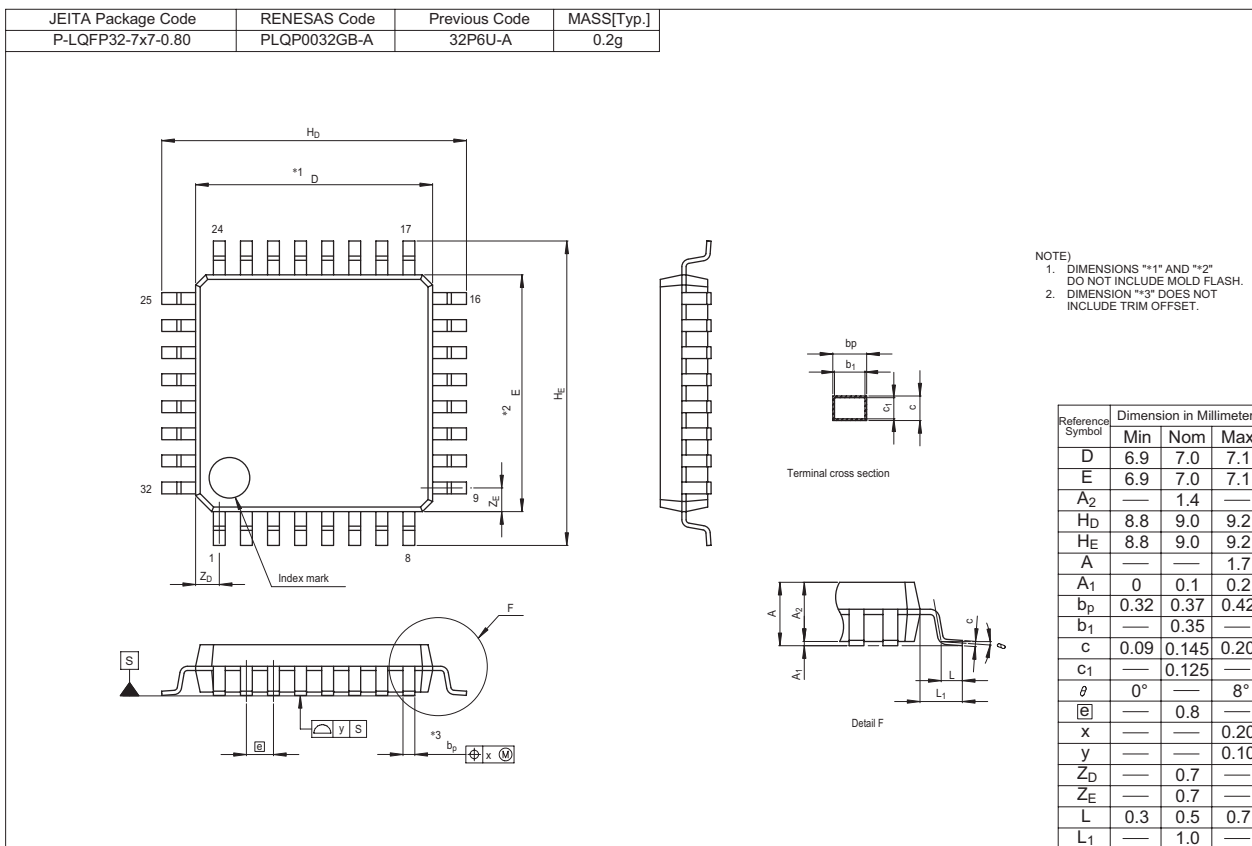



REVISION HISTORY	R8C/M13B Group Datasheet
------------------	--------------------------

Rev.	Date	Description	
		Page	Summary
1.00	Mar 14, 2011	–	First Edition issued
2.00	Mar 19, 2012	4	“Under development” deleted
		14	00028h “XCIN Clock Control Register”, “SUBCR”, “00h” deleted
		25	Table 4.3 revised

All trademarks and registered trademarks are the property of their respective owners.
---

## General Precautions in the Handling of MPU/MCU Products

The following usage notes are applicable to all MPU/MCU products from Renesas. For detailed usage notes on the products covered by this manual, refer to the relevant sections of the manual. If the descriptions under General Precautions in the Handling of MPU/MCU Products and in the body of the manual differ from each other, the description in the body of the manual takes precedence.

### 1. Handling of Unused Pins

Handle unused pins in accord with the directions given under Handling of Unused Pins in the manual.

- The input pins of CMOS products are generally in the high-impedance state. In operation with an unused pin in the open-circuit state, extra electromagnetic noise is induced in the vicinity of LSI, an associated shoot-through current flows internally, and malfunctions occur due to the false recognition of the pin state as an input signal become possible. Unused pins should be handled as described under Handling of Unused Pins in the manual.

### 2. Processing at Power-on

The state of the product is undefined at the moment when power is supplied.

- The states of internal circuits in the LSI are indeterminate and the states of register settings and pins are undefined at the moment when power is supplied.

In a finished product where the reset signal is applied to the external reset pin, the states of pins are not guaranteed from the moment when power is supplied until the reset process is completed.

In a similar way, the states of pins in a product that is reset by an on-chip power-on reset function are not guaranteed from the moment when power is supplied until the power reaches the level at which resetting has been specified.

### 3. Prohibition of Access to Reserved Addresses

Access to reserved addresses is prohibited.

- The reserved addresses are provided for the possible future expansion of functions. Do not access these addresses; the correct operation of LSI is not guaranteed if they are accessed.

### 4. Clock Signals

After applying a reset, only release the reset line after the operating clock signal has become stable. When switching the clock signal during program execution, wait until the target clock signal has stabilized.

- When the clock signal is generated with an external resonator (or from an external oscillator) during a reset, ensure that the reset line is only released after full stabilization of the clock signal. Moreover, when switching to a clock signal produced with an external resonator (or by an external oscillator) while program execution is in progress, wait until the target clock signal is stable.

### 5. Differences between Products

Before changing from one product to another, i.e. to one with a different part number, confirm that the change will not lead to problems.

- The characteristics of MPU/MCU in the same group but having different part numbers may differ because of the differences in internal memory capacity and layout pattern. When changing to products of different part numbers, implement a system-evaluation test for each of the products.

## Notice

- All information included in this document is current as of the date this document is issued. Such information, however, is subject to change without any prior notice. Before purchasing or using any Renesas Electronics products listed herein, please confirm the latest product information with a Renesas Electronics sales office. Also, please pay regular and careful attention to additional and different information to be disclosed by Renesas Electronics such as that disclosed through our website.
- Renesas Electronics does not assume any liability for infringement of patents, copyrights, or other intellectual property rights of third parties by or arising from the use of Renesas Electronics products or technical information described in this document. No license, express, implied or otherwise, is granted hereby under any patents, copyrights or other intellectual property rights of Renesas Electronics or others.
- You should not alter, modify, copy, or otherwise misappropriate any Renesas Electronics product, whether in whole or in part.
- Descriptions of circuits, software and other related information in this document are provided only to illustrate the operation of semiconductor products and application examples. You are fully responsible for the incorporation of these circuits, software, and information in the design of your equipment. Renesas Electronics assumes no responsibility for any losses incurred by you or third parties arising from the use of these circuits, software, or information.
- When exporting the products or technology described in this document, you should comply with the applicable export control laws and regulations and follow the procedures required by such laws and regulations. You should not use Renesas Electronics products or the technology described in this document for any purpose relating to military applications or use by the military, including but not limited to the development of weapons of mass destruction. Renesas Electronics products and technology may not be used for or incorporated into any products or systems whose manufacture, use, or sale is prohibited under any applicable domestic or foreign laws or regulations.
- Renesas Electronics has used reasonable care in preparing the information included in this document, but Renesas Electronics does not warrant that such information is error free. Renesas Electronics assumes no liability whatsoever for any damages incurred by you resulting from errors in or omissions from the information included herein.
- Renesas Electronics products are classified according to the following three quality grades: "Standard", "High Quality", and "Specific". The recommended applications for each Renesas Electronics product depends on the product's quality grade, as indicated below. You must check the quality grade of each Renesas Electronics product before using it in a particular application. You may not use any Renesas Electronics product for any application categorized as "Specific" without the prior written consent of Renesas Electronics. Further, you may not use any Renesas Electronics product for any application for which it is not intended without the prior written consent of Renesas Electronics. Renesas Electronics shall not be in any way liable for any damages or losses incurred by you or third parties arising from the use of any Renesas Electronics product for an application categorized as "Specific" or for which the product is not intended where you have failed to obtain the prior written consent of Renesas Electronics. The quality grade of each Renesas Electronics product is "Standard" unless otherwise expressly specified in a Renesas Electronics data sheets or data books, etc.  
"Standard": Computers; office equipment; communications equipment; test and measurement equipment; audio and visual equipment; home electronic appliances; machine tools; personal electronic equipment; and industrial robots.  
"High Quality": Transportation equipment (automobiles, trains, ships, etc.); traffic control systems; anti-disaster systems; anti-crime systems; safety equipment; and medical equipment not specifically designed for life support.  
"Specific": Aircraft; aerospace equipment; submersible repeaters; nuclear reactor control systems; medical equipment or systems for life support (e.g. artificial life support devices or systems), surgical implantations, or healthcare intervention (e.g. excision, etc.), and any other applications or purposes that pose a direct threat to human life.
- You should use the Renesas Electronics products described in this document within the range specified by Renesas Electronics, especially with respect to the maximum rating, operating supply voltage range, movement power voltage range, heat radiation characteristics, installation and other product characteristics. Renesas Electronics shall have no liability for malfunctions or damages arising out of the use of Renesas Electronics products beyond such specified ranges.
- Although Renesas Electronics endeavors to improve the quality and reliability of its products, semiconductor products have specific characteristics such as the occurrence of failure at a certain rate and malfunctions under certain use conditions. Further, Renesas Electronics products are not subject to radiation resistance design. Please be sure to implement safety measures to guard them against the possibility of physical injury, and injury or damage caused by fire in the event of the failure of a Renesas Electronics product, such as safety design for hardware and software including but not limited to redundancy, fire control and malfunction prevention, appropriate treatment for aging degradation or any other appropriate measures. Because the evaluation of microcomputer software alone is very difficult, please evaluate the safety of the final products or system manufactured by you.
- Please contact a Renesas Electronics sales office for details as to environmental matters such as the environmental compatibility of each Renesas Electronics product. Please use Renesas Electronics products in compliance with all applicable laws and regulations that regulate the inclusion or use of controlled substances, including without limitation, the EU RoHS Directive. Renesas Electronics assumes no liability for damages or losses occurring as a result of your noncompliance with applicable laws and regulations.
- This document may not be reproduced or duplicated, in any form, in whole or in part, without prior written consent of Renesas Electronics.
- Please contact a Renesas Electronics sales office if you have any questions regarding the information contained in this document or Renesas Electronics products, or if you have any other inquiries.  
(Note 1) "Renesas Electronics" as used in this document means Renesas Electronics Corporation and also includes its majority-owned subsidiaries.  
(Note 2) "Renesas Electronics product(s)" means any product developed or manufactured by or for Renesas Electronics.



### SALES OFFICES

Renesas Electronics Corporation

<http://www.renesas.com>

Refer to "<http://www.renesas.com/>" for the latest and detailed information.

**Renesas Electronics America Inc.**  
2880 Scott Boulevard Santa Clara, CA 95050-2554, U.S.A.  
Tel: +1-408-588-6000, Fax: +1-408-588-6130

**Renesas Electronics Canada Limited**  
1101 Nicholson Road, Newmarket, Ontario L3Y 9C3, Canada  
Tel: +1-905-898-5441, Fax: +1-905-898-3220

**Renesas Electronics Europe Limited**  
Dukes Meadow, Millboard Road, Bourne End, Buckinghamshire, SL8 5FH, U.K.  
Tel: +44-1628-585-100, Fax: +44-1628-585-900

**Renesas Electronics Europe GmbH**  
Arcadiastrasse 10, 40472 Düsseldorf, Germany  
Tel: +49-211-65030, Fax: +49-211-6503-1327

**Renesas Electronics (China) Co., Ltd.**  
7th Floor, Quantum Plaza, No.27 ZhiChunLu Haidian District, Beijing 100083, P.R.China  
Tel: +86-10-8235-1155, Fax: +86-10-8235-7679

**Renesas Electronics (Shanghai) Co., Ltd.**  
Unit 204, 205, AZIA Center, No.1233 Lujiazui Ring Rd., Pudong District, Shanghai 200120, China  
Tel: +86-21-5877-1818, Fax: +86-21-6887-7858 / -7898

**Renesas Electronics Hong Kong Limited**  
Unit 1601-1613, 16/F., Tower 2, Grand Century Place, 193 Prince Edward Road West, Mongkok, Kowloon, Hong Kong  
Tel: +852-2886-9318, Fax: +852 2886-9022/9044

**Renesas Electronics Taiwan Co., Ltd.**  
13F, No. 363, Fu Shing North Road, Taipei, Taiwan  
Tel: +886-2-8175-9600, Fax: +886 2-8175-9670

**Renesas Electronics Singapore Pte. Ltd.**  
1 HarbourFront Avenue, #06-10, Keppel Bay Tower, Singapore 098632  
Tel: +65-6213-0200, Fax: +65-6278-8001

**Renesas Electronics Malaysia Sdn.Bhd.**  
Unit 906, Block B, Menara Amcorp, Amcorp Trade Centre, No. 18, Jln Persiaran Barat, 46050 Petaling Jaya, Selangor Darul Ehsan, Malaysia  
Tel: +60-3-7955-9390, Fax: +60-3-7955-9510

**Renesas Electronics Korea Co., Ltd.**  
11F., Samik Lavied' or Bldg., 720-2 Yeoksam-Dong, Kangnam-Ku, Seoul 135-080, Korea  
Tel: +82-2-558-3737, Fax: +82-2-558-5141