

# HCA65R099FE (Fast Recovery Diode Type)

## 650V N-Channel Super Junction MOSFET

### Features

- Very Low FOM ( $R_{DS(on)} \times Q_g$ )
- Extremely low switching loss
- Excellent stability and uniformity
- 100% Avalanche Tested
- Higher reverse recovery dv/dt
- Fast Recovery Time

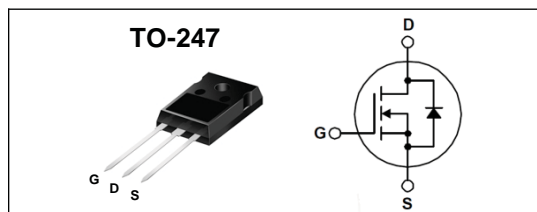
### Application

- Telecom Power equipment / Server station
- Uninterruptible Power Supply (UPS)
- Micro Solar Inverter & EV Charger
- Suitable for soft switching (ZVS Full bridge & LLC) demanding high efficiency

### Key Parameters

Parameter	Value	Unit
$BV_{DSS} @ T_{j,max}$	700	V
$I_D$	40	A
$R_{DS(on), max}$	99	m $\Omega$
$Q_g, Typ$	45	nC

### Package & Internal Circuit



### Absolute Maximum Ratings $T_C=25^\circ\text{C}$ unless otherwise specified

Symbol	Parameter	Value	Units
$V_{DSS}$	Drain-Source Voltage	650	V
$V_{GS}$	Gate-Source Voltage	$\pm 30$	V
$I_D$	Drain Current – Continuous ( $T_C = 25^\circ\text{C}$ )	40	A
	Drain Current – Continuous ( $T_C = 100^\circ\text{C}$ )	25	A
$I_{DM}$	Drain Current – Pulsed (Note 1)	120	A
$E_{AS}$	Single Pulsed Avalanche Energy (Note 2)	1000	mJ
dv/dt	MOSFET dv/dt ruggedness, $V_{DS}=0\dots 480\text{V}$	100	V/ns
dv/dt	Reverse diode dv/dt, $V_{DS}=0\dots 480\text{V}$ , $I_{DS} \leq I_D$	50	V/ns
$P_D$	Power Dissipation	278	W
$T_J, T_{STG}$	Operating and Storage Temperature Range	-55 to +150	$^\circ\text{C}$
$T_L$	Maximum lead temperature for soldering purposes, 1/8" from case for 5 seconds	300	$^\circ\text{C}$

### Thermal Resistance Characteristics

Symbol	Parameter	Typ.	Max.	Units
$R_{\theta JC}$	Junction-to-Case	--	0.45	$^\circ\text{C}/\text{W}$
$R_{\theta JA}$	Junction-to-Ambient	--	40	

**Electrical Characteristics**  $T_J=25\text{ }^\circ\text{C}$  unless otherwise specified

Symbol	Parameter	Test Conditions	Min	Typ	Max	Units
--------	-----------	-----------------	-----	-----	-----	-------

**On Characteristics**

$V_{GS}$	Gate Threshold Voltage	$V_{DS} = V_{GS}, I_D = 2\text{ mA}$	2.5	--	4.5	V
$R_{DS(ON)}$	Static Drain-Source On-Resistance	$V_{GS} = 10\text{ V}, I_D = 20\text{ A}$	--	88	99	m $\Omega$

**Off Characteristics**

$BV_{DSS}$	Drain-Source Breakdown Voltage	$V_{GS} = 0\text{ V}, I_D = 1\text{ mA}$	650	--	--	V
$I_{DSS}$	Zero Gate Voltage Drain Current	$V_{DS} = 650\text{ V}, V_{GS} = 0\text{ V}$	--	--	10	$\mu\text{A}$
		$V_{DS} = 520\text{ V}, T_J = 125\text{ }^\circ\text{C}$	--	--	100	$\mu\text{A}$
$I_{GSS}$	Gate-Body Leakage Current	$V_{GS} = \pm 30\text{ V}, V_{DS} = 0\text{ V}$	--	--	$\pm 100$	nA

**Dynamic Characteristics**

$C_{iss}$	Input Capacitance	$V_{DS} = 50\text{ V}, V_{GS} = 0\text{ V},$ $f = 1.0\text{ MHz}$	--	3300	--	pF
$C_{oss}$	Output Capacitance		--	210	--	pF
$C_{rss}$	Reverse Transfer Capacitance		--	12	--	pF

**Switching Characteristics**

$t_{d(on)}$	Turn-On Time	$V_{DS} = 325\text{ V}, I_D = 20\text{ A},$ $R_G = 25\text{ }\Omega$	--	80	--	ns
$t_r$	Turn-On Rise Time		--	25	--	ns
$t_{d(off)}$	Turn-Off Delay Time		--	120	--	ns
$t_f$	Turn-Off Fall Time		--	16	--	ns
$Q_g$	Total Gate Charge	$V_{DS} = 520\text{ V}, I_D = 20\text{ A}$ $V_{GS} = 10\text{ V}$	--	45	60	nC
$Q_{gs}$	Gate-Source Charge		--	18	--	nC
$Q_{gd}$	Gate-Drain Charge		--	8	--	nC

**Source-Drain Diode Maximum Ratings and Characteristics**

$I_S$	Continuous Source-Drain Diode Forward Current	--	--	40	A	
$I_{SM}$	Pulsed Source-Drain Diode Forward Current	--	--	120		
$V_{SD}$	Source-Drain Diode Forward Voltage	$I_S = 20\text{ A}, V_{GS} = 0\text{ V}$	--	--	1.4	V
$t_{rr}$	Reverse Recovery Time	$I_S = 20\text{ A}, V_{GS} = 0\text{ V}$ $di_F/dt = 100\text{ A}/\mu\text{s}$	--	162	--	ns
$Q_{rr}$	Reverse Recovery Charge		--	1.12	--	$\mu\text{C}$

**Notes ;**

1. Repetitive Rating : Pulse width limited by maximum junction temperature
2.  $L=80\text{mH}, V_{DD}=50\text{V}, R_G=25\Omega,$  Starting  $T_J=25^\circ\text{C}$
3. Pulse Test : Pulse Width  $\leq 300\mu\text{s},$  Duty Cycle  $\leq 2\%$

## Typical Characteristics

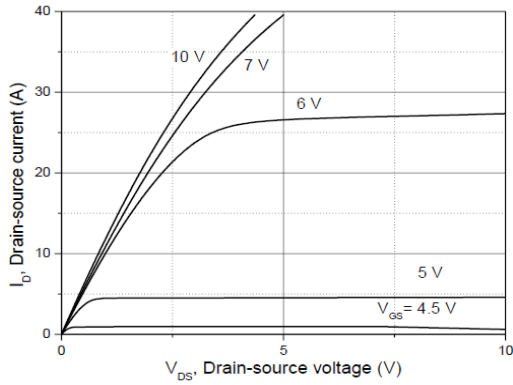


Figure 1. On Region Characteristics

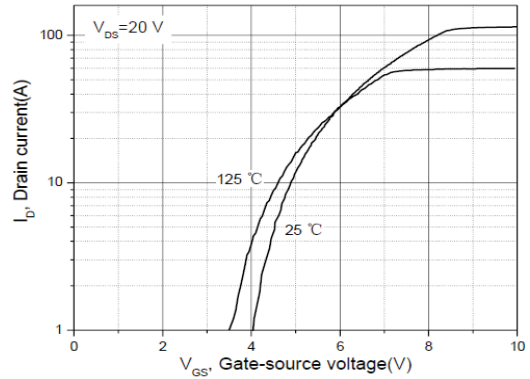


Figure 2. Transfer Characteristics

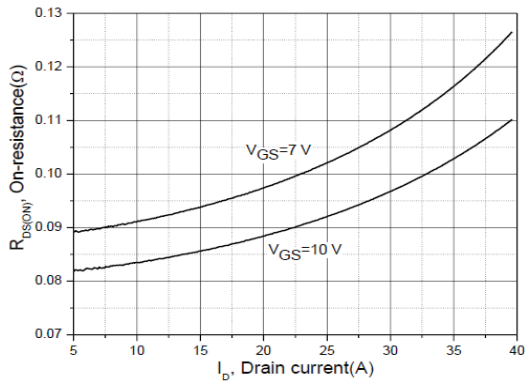


Figure 3. On Resistance Variation vs Drain Current and Gate Voltage

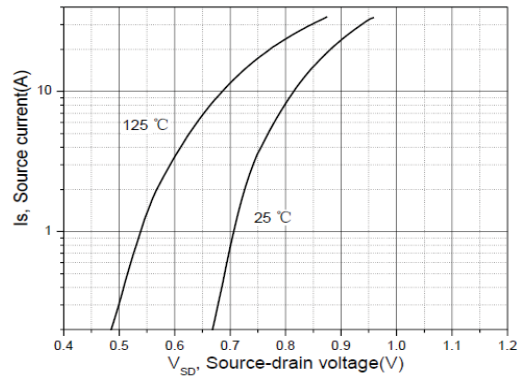


Figure 4. Body Diode Forward Voltage Variation with Source Current and Temperature

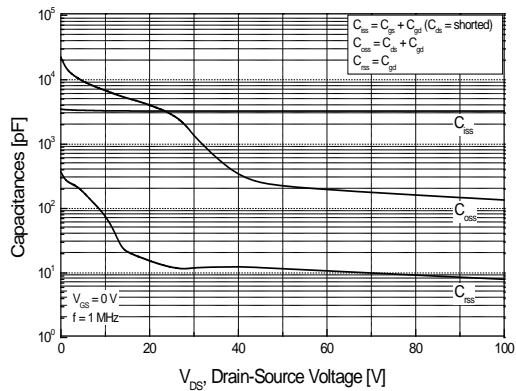


Figure 5. Capacitance Characteristics

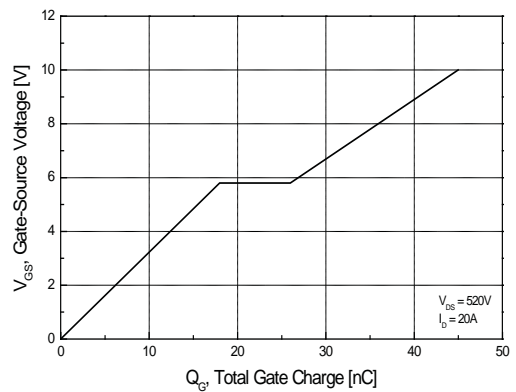
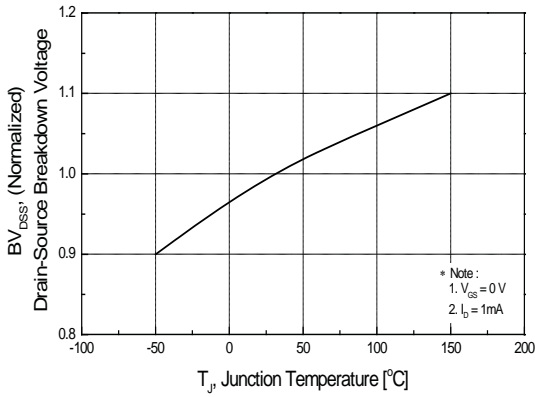
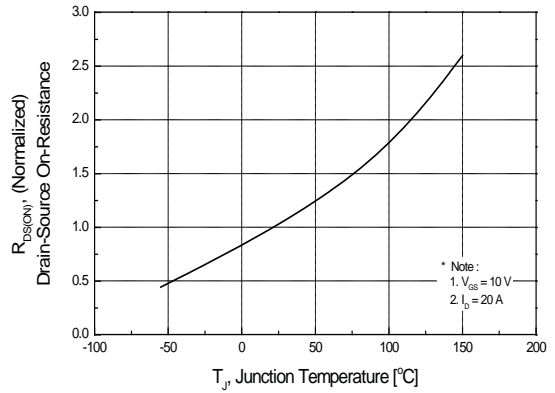


Figure 6. Gate Charge Characteristics

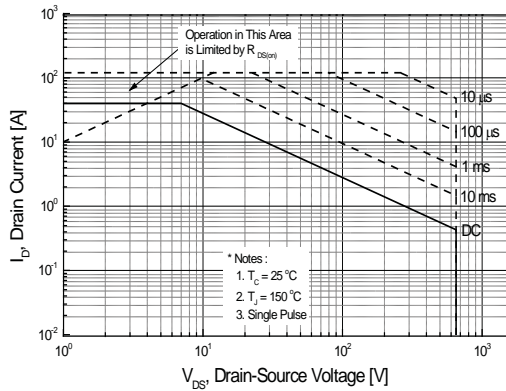
**Typical Characteristics (continued)**



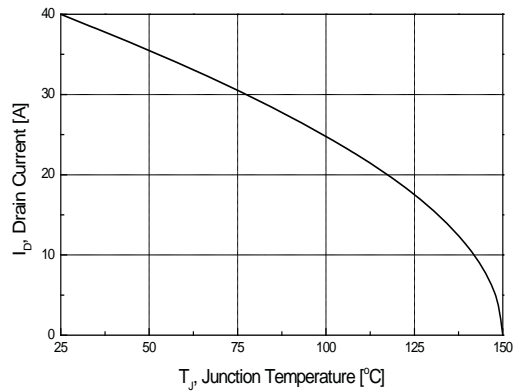
**Figure 7. Breakdown Voltage Variation vs Temperature**



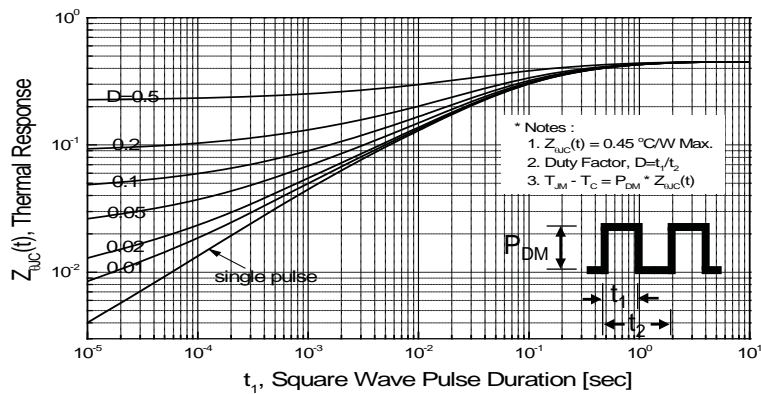
**Figure 8. On-Resistance Variation vs Temperature**



**Figure 9. Maximum Safe Operating Area**

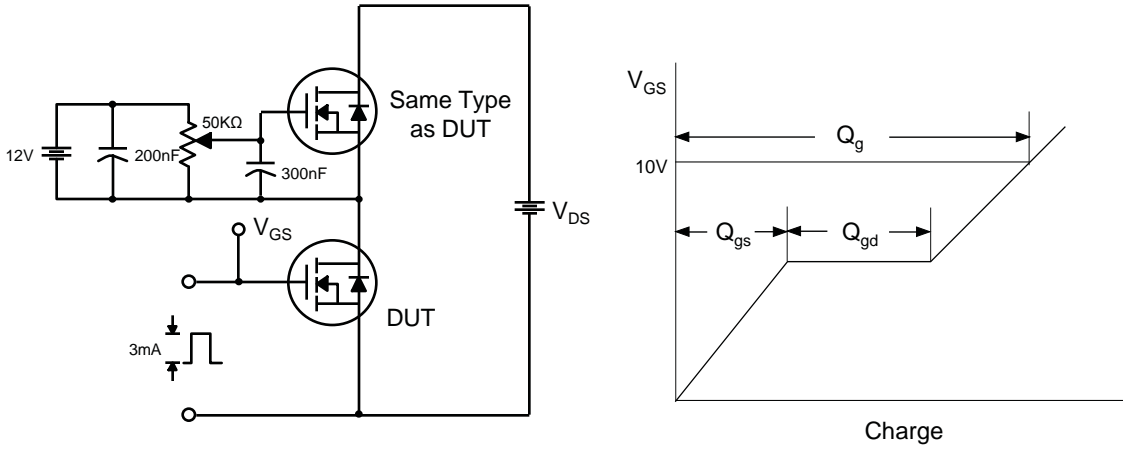


**Figure 10. Maximum Drain Current vs Case Temperature**

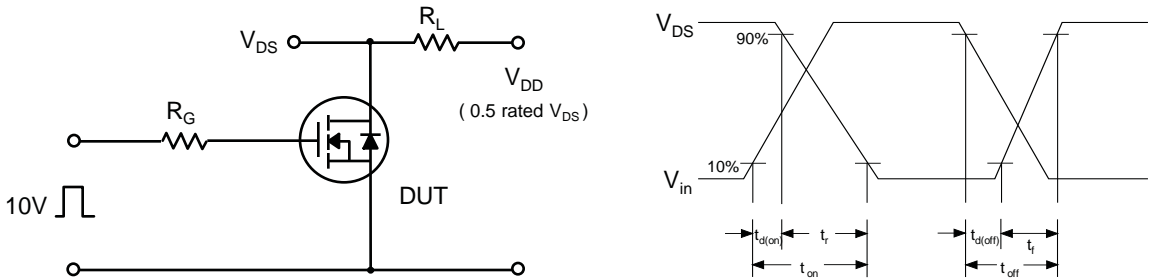


**Figure 11. Transient Thermal Response Curve**

**Fig 12. Gate Charge Test Circuit & Waveform**



**Fig 13. Resistive Switching Test Circuit & Waveforms**



**Fig 14. Unclamped Inductive Switching Test Circuit & Waveforms**

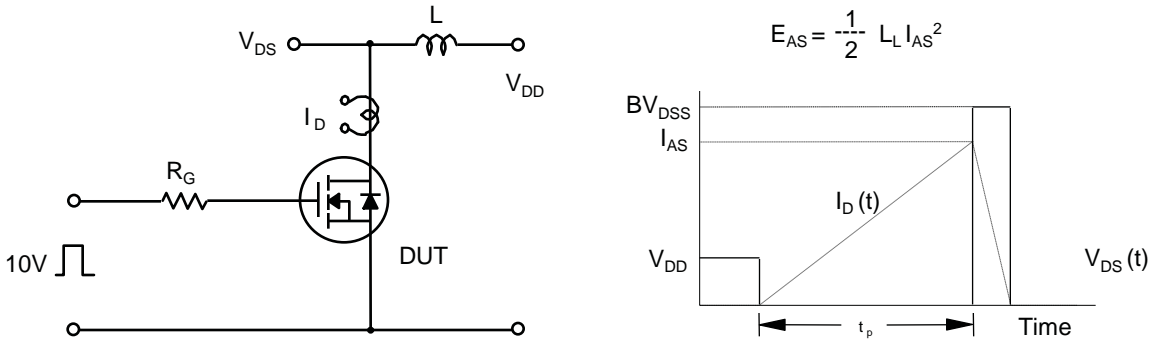
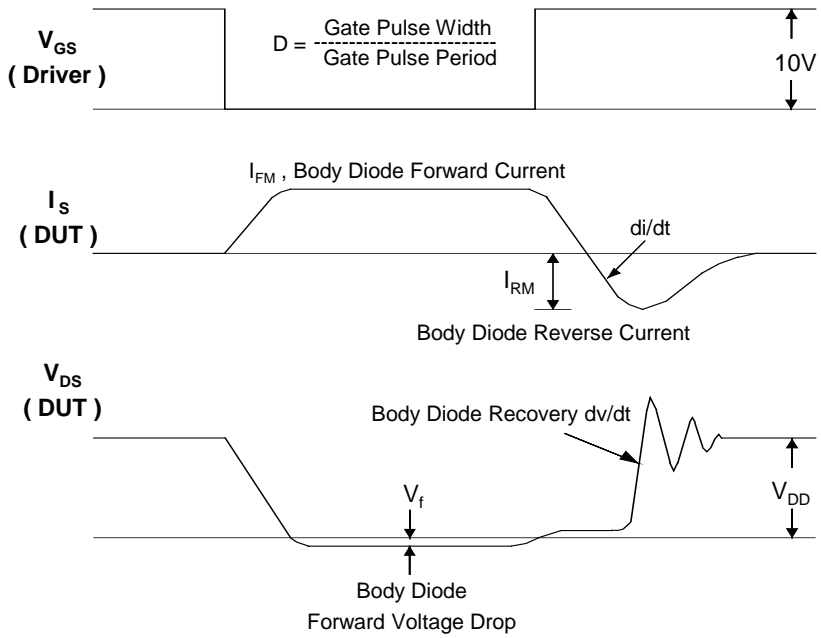
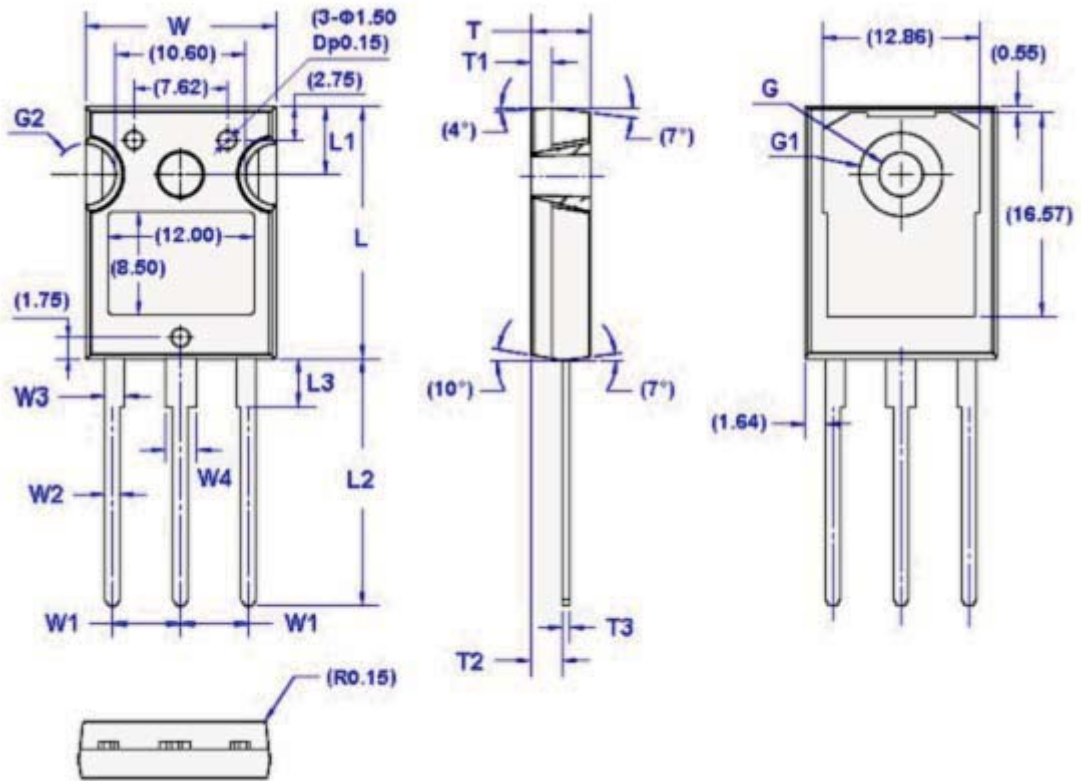


Fig 15. Peak Diode Recovery dv/dt Test Circuit & Waveforms



Package Dimension

TO-247



( Unit : mm )

Symbol	Size		Symbol	Size	
	Min	Max		Min	Max
W	15.4	15.8	W4	2.44	2.64
W1	5.56 (TYP)		L	20.4	20.8
W2	1.17	1.35	L1	5.36	5.56
W3	1.55	1.75	L2	19.8	20.2
L3	3.69	3.93	T3	0.51	0.69
T	4.6	4.8	G(Φ)	3.51	3.65
T1	1.4	1.6	G1(Φ)	6.61	6.85
T2	2.3	2.5	G2(Φ)	4.96	5.2