

Applications

- Commercial and Military Radar
- Satellite Communications
- Point to Point Radio
- Electronic Warfare
- General Purpose

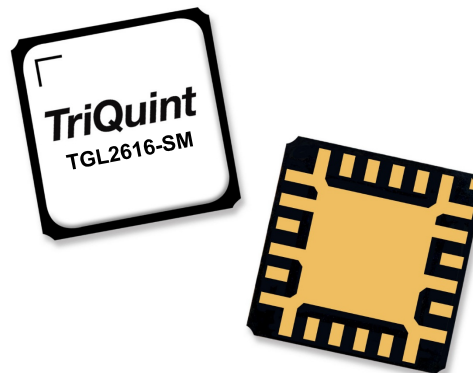

Product Features

- Frequency Range: 10-20 GHz
- 5-Bit Digital Attenuator
- Attenuation Range: 23.25 dB
- Attenuation Step Size (LSB): 0.75 dB
- Insertion Loss (Ref. State): 4.8 dB
- RMS Amplitude Error: < 0.6 dB
- RMS Step Error: < 0.3 dB
- Control Voltage: 3.3-5.0 V
- Positive logic
- Package Size: 4.0 x 4.0 x 1.45 mm

Functional Block Diagram

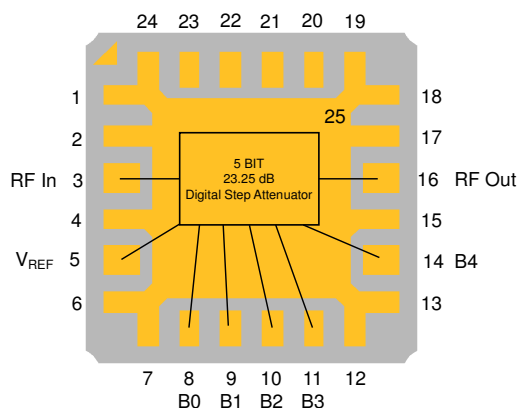

General Description

TriQuint's TGL2616-SM is a 5-bit digital attenuator using TQPHT15, TriQuint's production 0.15um GaAs pHEMT process. Operating from 10 – 20 GHz, the TGL2616-SM offers a low LSB of only 0.75 dB and supports > 23 dB of attenuation range with a low RMS step error of < 0.3 dB.

Using standard, positive control voltages, offered in a 4x4mm air cavity QFN, and offering excellent broadband performance, the TGL2216-SM is ideal for supporting a variety of commercial and military applications.

Lead-free and RoHS compliant.

Evaluation Boards available on request.

Pad Configuration

Pad Number	Symbol
1,2,4,6,7,12,13,15,17,18,19,24,25	GND
3	RF Input
16	RF Output
14	B4 (12 dB bit)
11	B3 (6 dB bit)
10	B2 (3 dB bit)
9	B1 (1.5 dB bit)
8	B0 (0.75 dB bit)
5	V _{REF}
20-23	N/C

Ordering Information

Part	ECCN	Description
TGL2616-SM	EAR99	10-20 GHz 5-Bit Digital Attenuator

Absolute Maximum Ratings

Parameter	Value
Control Voltage (V_C)	6 V
Control Current (I_C)	1 mA
Input Power (P_{IN})	35 dBm
Power Dissipation (P_{DISS})	0.7 W
Operating Channel Temperature	150 °C

Operation of this device outside the parameter ranges given above may cause permanent damage. These are stress ratings only, and functional operation of the device at these conditions is not implied.

Recommended Operating Conditions

Parameter	Value
Reference Voltage ¹	3.3-5 V
Control Voltage (logic L / H) ¹	0 / 3.3-5 V

Note:

1. $V_{REF} \geq V_C$

Electrical specifications are measured at specified test conditions. Specifications are not guaranteed over all recommended operating conditions.

Electrical Specifications

Test conditions, unless otherwise noted: 25 °C, $V_{REF} = 3.3$ V, $V_C = 0 / 3.3$ V. Tested with DUT on EVB on page 9

Parameter	Min	Typical	Max	Units
Frequency Range	10		20	GHz
LSB Attenuation		0.75		dB
Attenuation range		23.25		dB
Reference State Insertion Loss		4.8		dB
Input Return Loss		> 8		dB
Output Return Loss		> 12		dB
IIP3 (10 MHz spacing, $P_{IN}/Tone=10$ dBm, 15 GHz) ¹		> 36		dBm
Switching Speed (90% to 10%)		< 10		ns
RMS Attenuation Error		< 0.7		dB
RMS Step Error		< 0.3		dB
Max. Attenuation Error		< 1.1		dB

¹ TGA2616 die performance.

Specifications

Thermal and Reliability Information

Parameter	Conditions	Value	Units
Thermal Resistance (θ_{JC}) ⁽¹⁾	T _{BASE} = 85 °C, V _{REF} = 3.3 V, V _C = 3.3 V, P _{DISS} = 0.09 W	22	°C/W
Channel Temperature (T _{CH}) ⁽¹⁾		87	°C
Median Lifetime (T _M)		3.8E+09	Hrs

Note:

- 1. Package base backside temperature fixed at 85 °C.

Median Lifetime

Test Conditions: 6.0 V; Failure Criterion = 10% reduction in I_{D MAX}

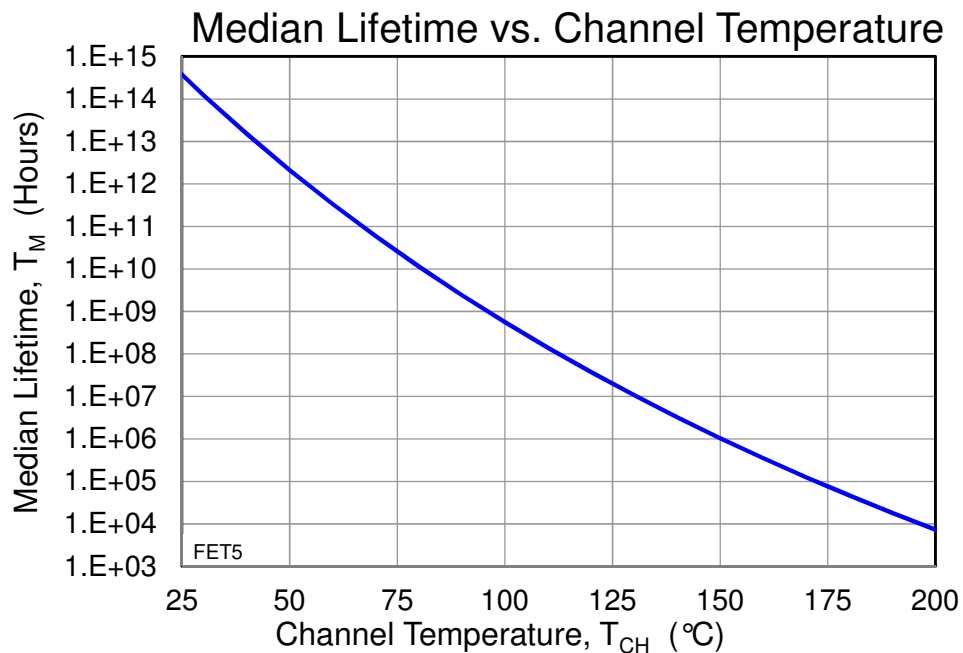

Typical Performance

Test conditions unless otherwise noted: Tested with DUT on EVB on page 9.

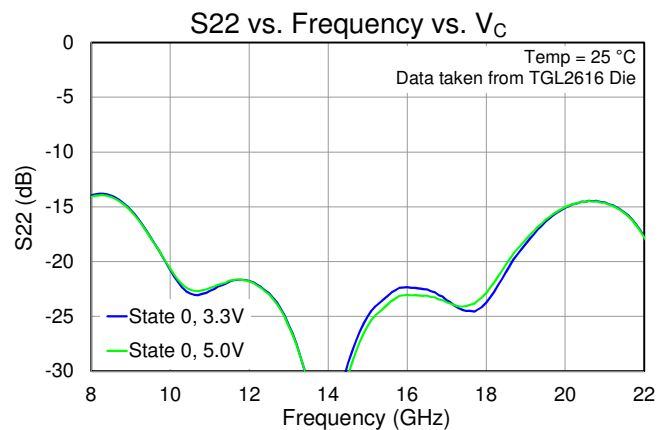
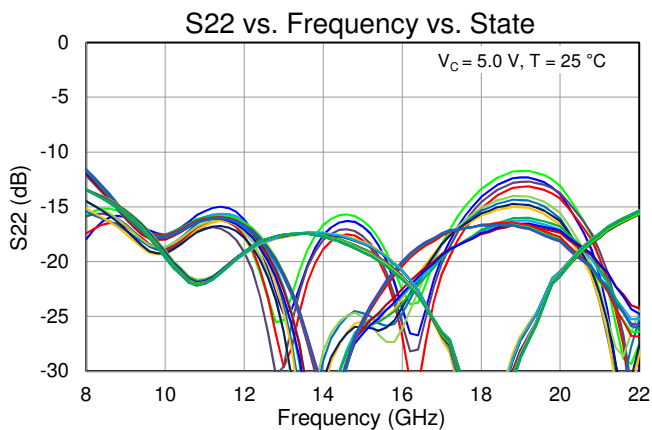
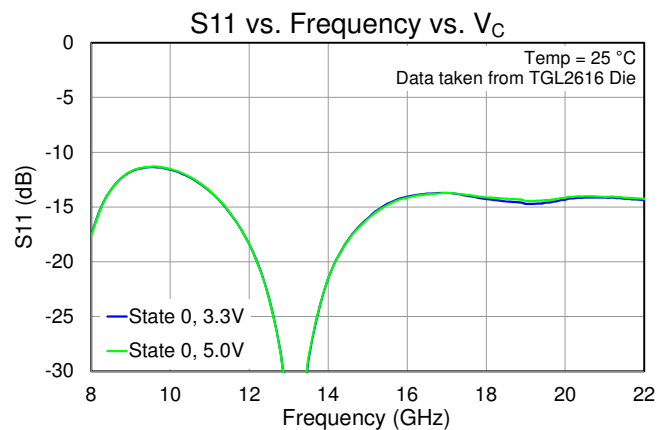
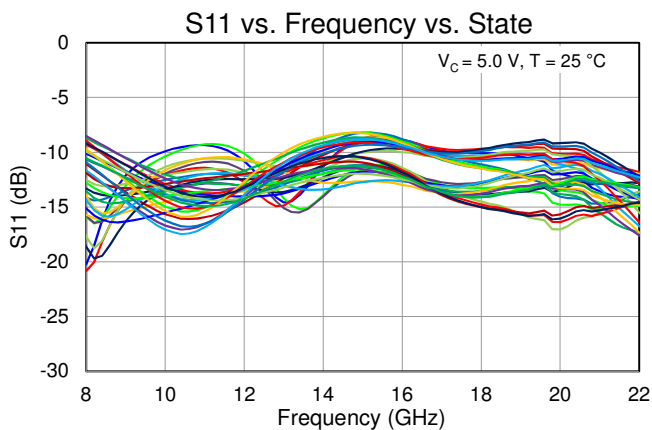
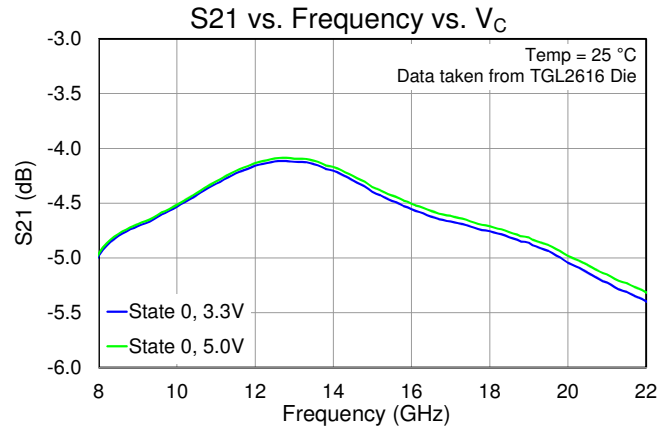
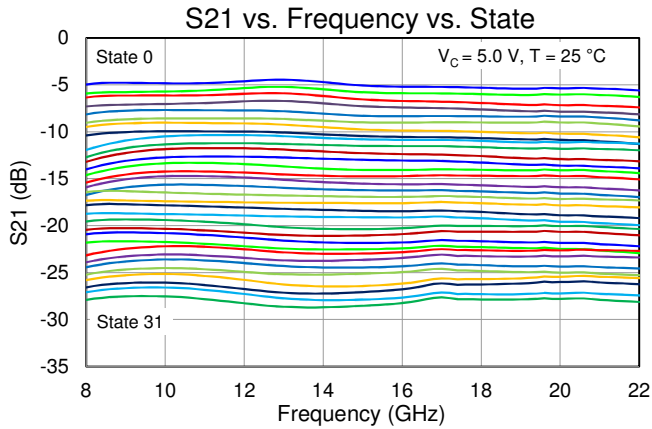

Typical Performance

Test conditions unless otherwise noted: Tested with DUT on EVB on page 9.

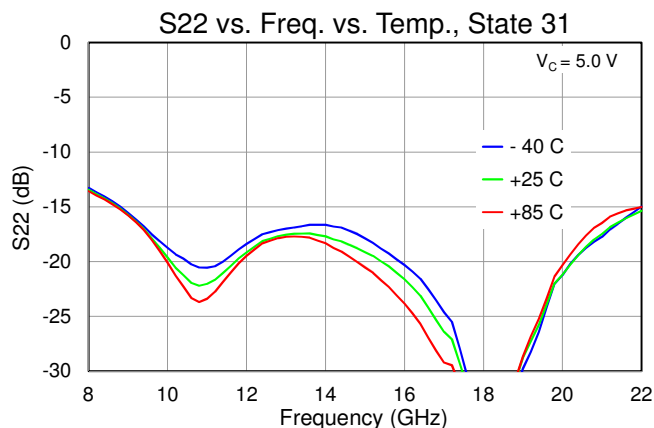
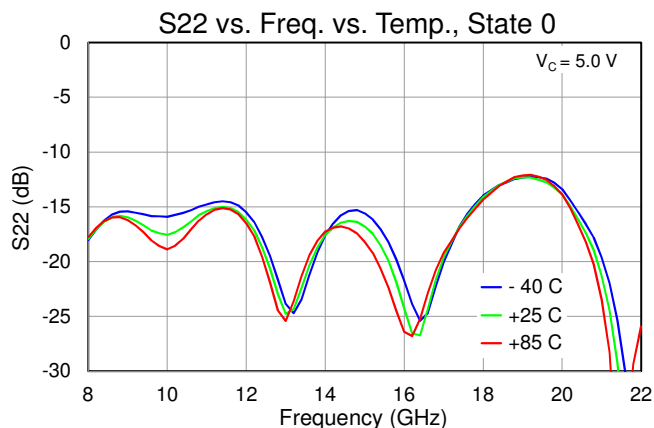
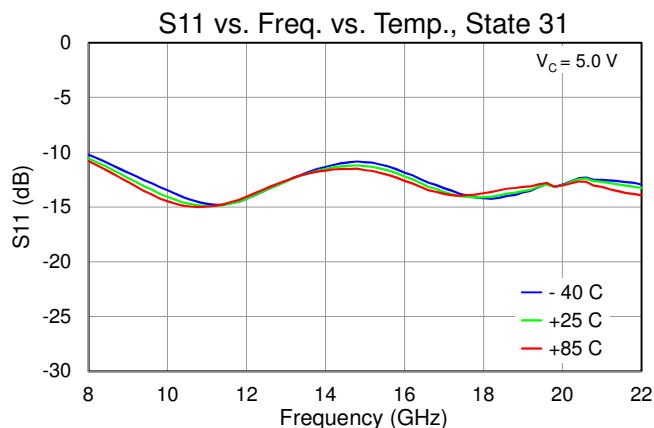
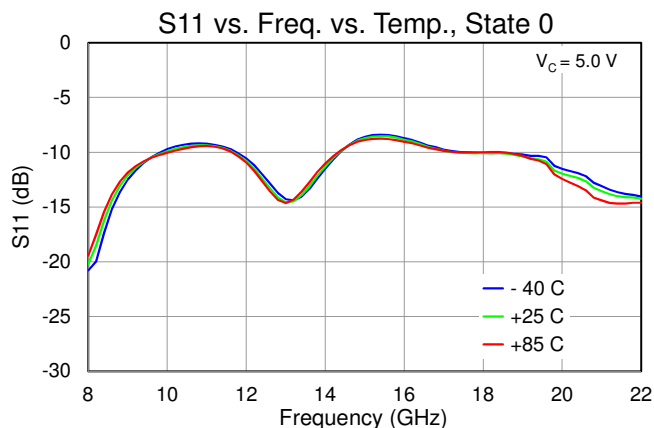
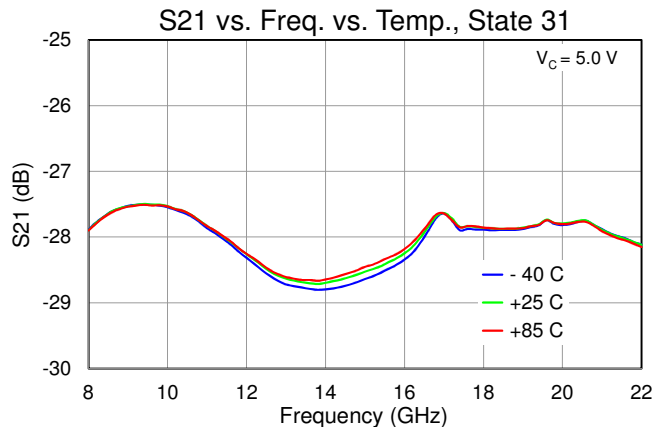
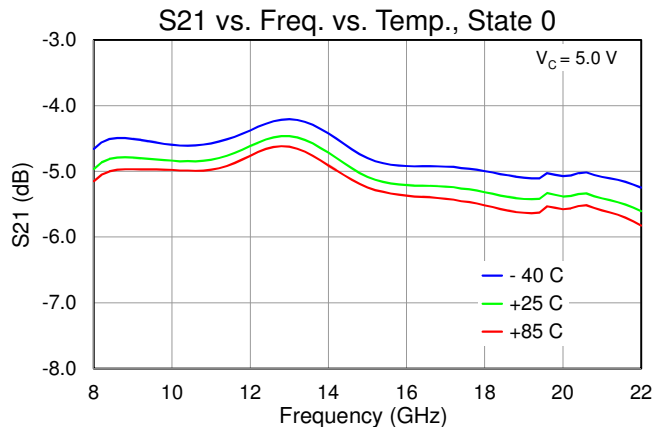

Typical Performance

Test conditions unless otherwise noted: Tested with DUT on EVB on page 9.

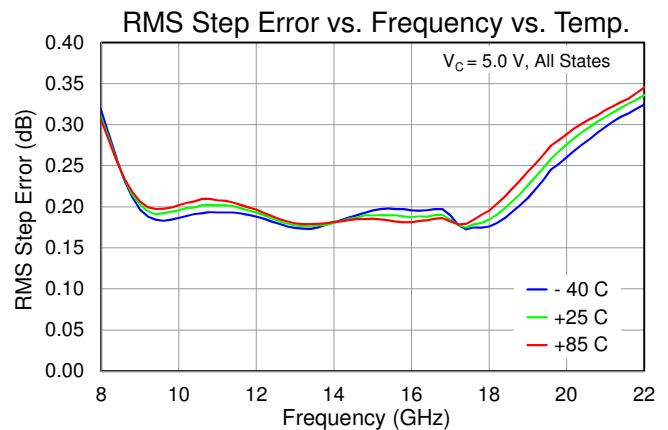
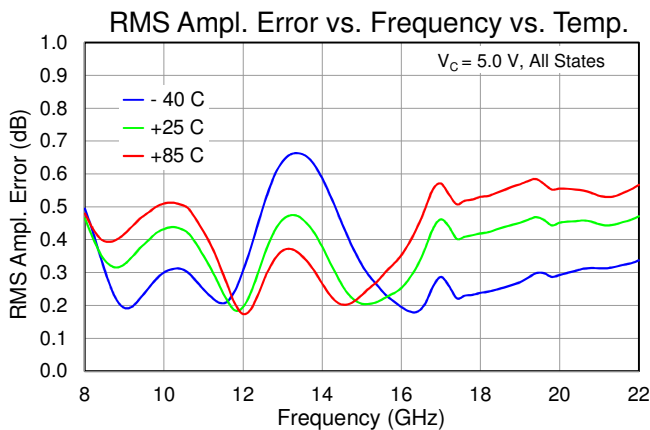
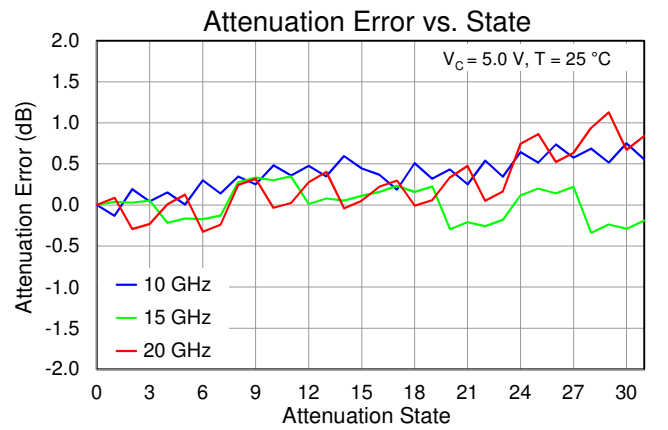
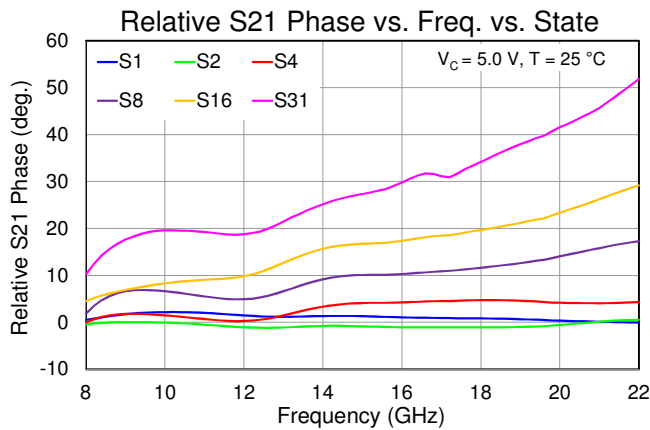
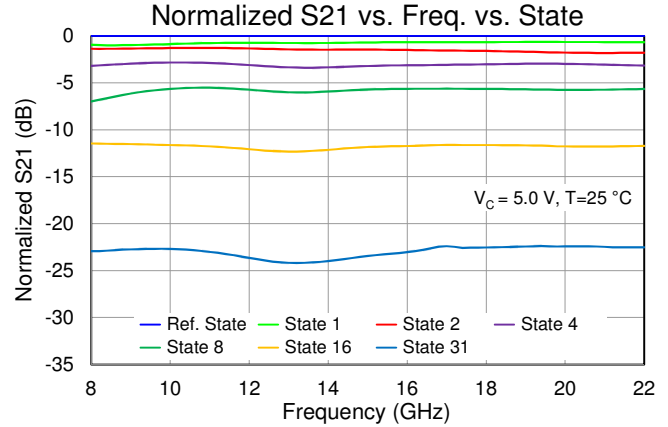
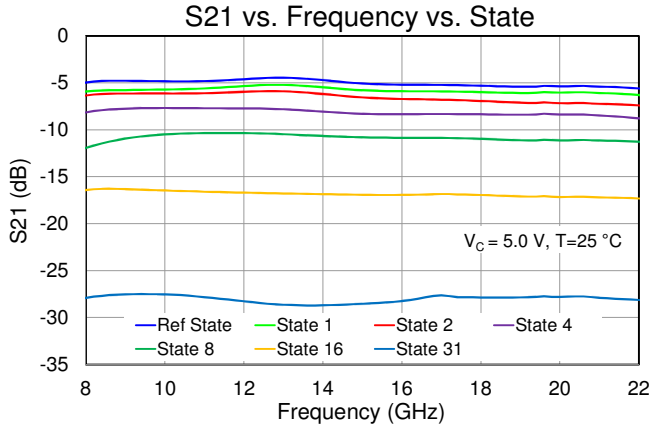

Typical Performance

Test conditions unless otherwise noted: Tested with DUT on EVB on page 9. Gain, IIP3 plots are from the TGA2616 die.

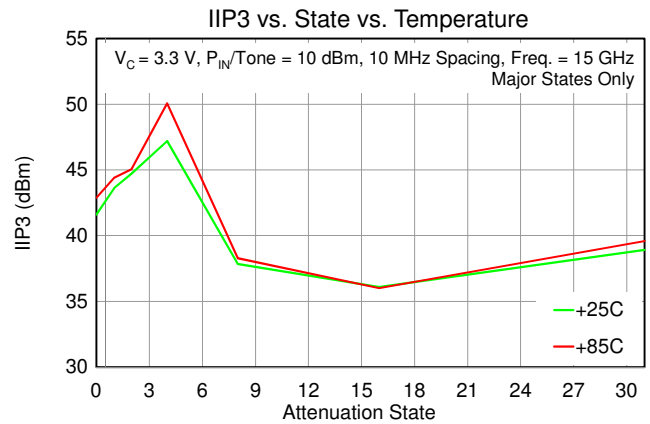
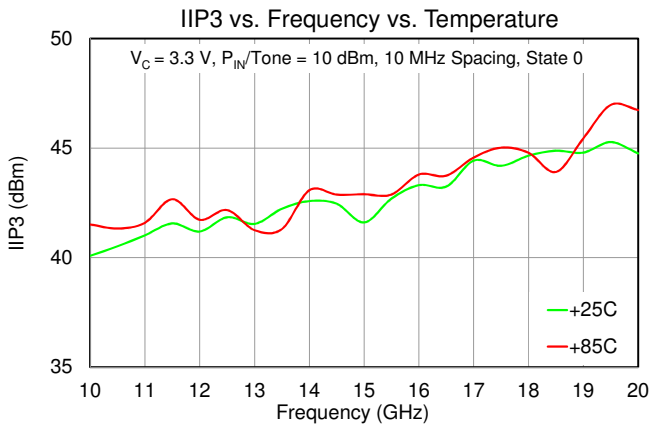
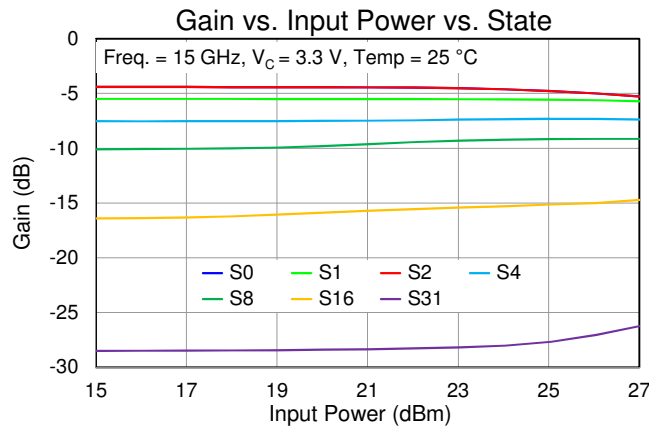
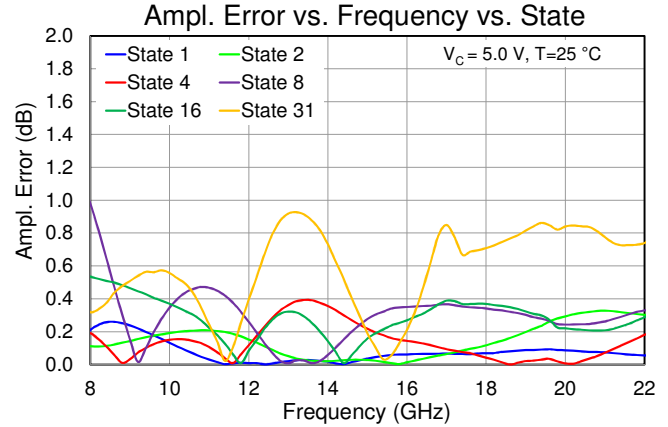
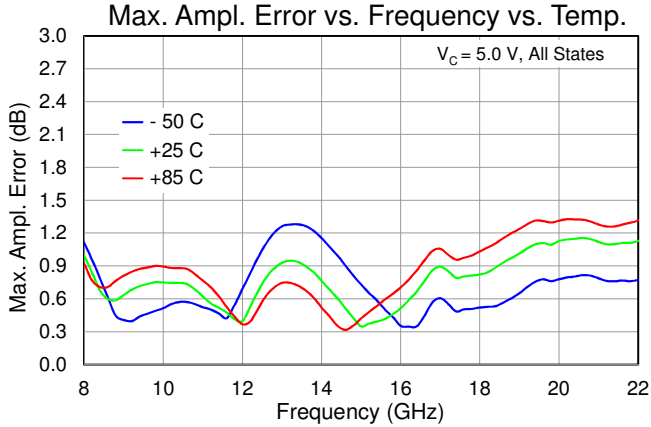

Application Circuit

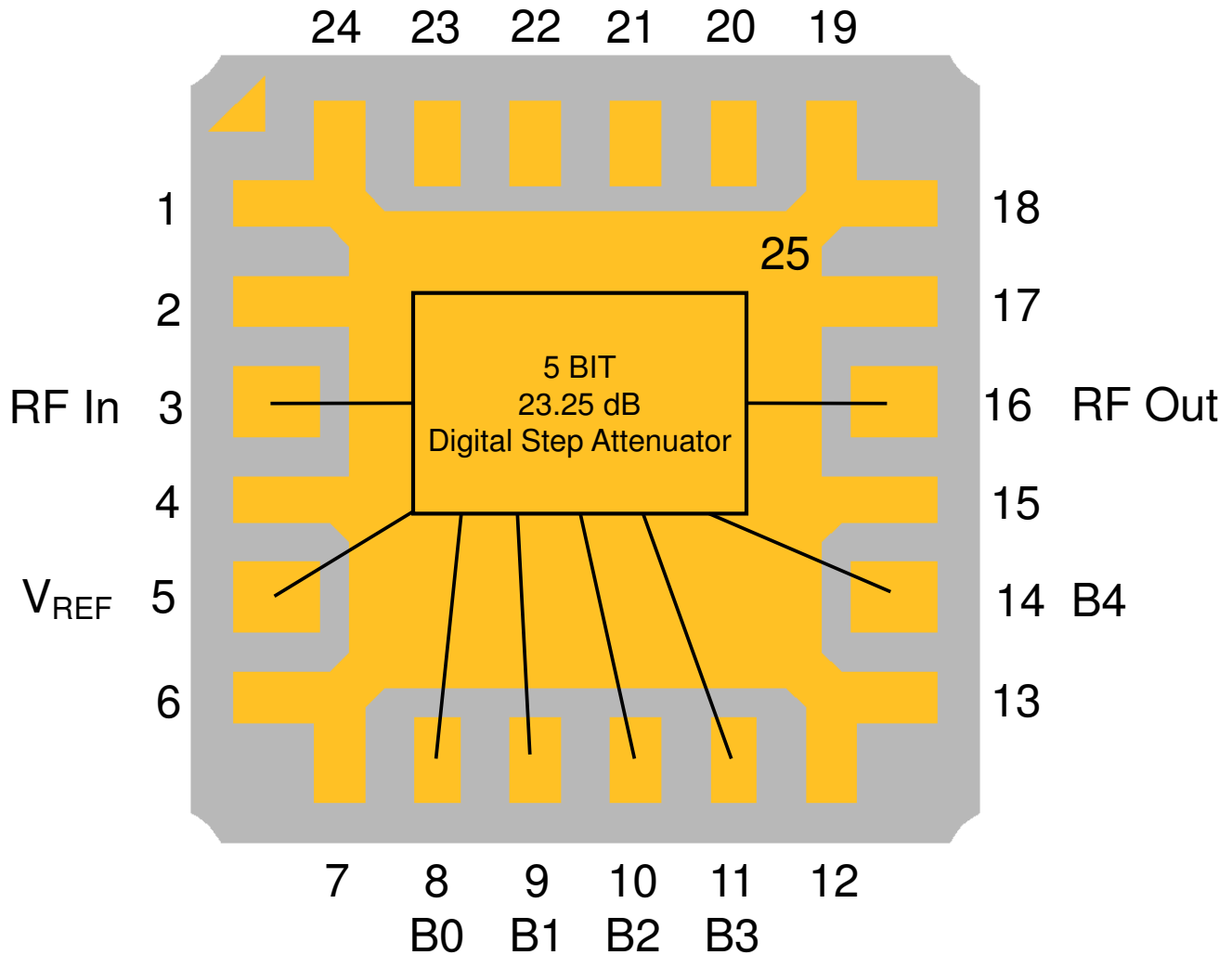

Function Table – Major States

Parameter	State	B0	B1	B2	B3	B4
0 dB Attenuation (Ref. State)	State 0	L	L	L	L	L
0.75 dB Attenuation	State 1	H	L	L	L	L
1.5 dB Attenuation	State 2	L	H	L	L	L
3.0 dB Attenuation	State 4	L	L	H	L	L
6.0 dB Attenuation	State 8	L	L	L	H	L
12.0 dB Attenuation	State 16	L	L	L	L	H
23.25 dB Attenuation	State 31	H	H	H	H	H

Intermediate attenuation states are combinations of the above major states.
Logic L = 0V. Logic H = 3.3-5.0 V

Applications Information

Evaluation Board Layout

RF Layer is 0.008" thick Rogers Corp. RO4003C, $\epsilon_r = 3.38$. Metal layers are 0.5 oz. copper. The microstrip line at the connector interface is optimized for the Southwest Microwave end launch connector 1092-02A-5.

The pad pattern shown has been developed and tested for optimized assembly at TriQuint Semiconductor. The PCB land pattern has been developed to accommodate lead and package tolerances. Since surface mount processes vary from company to company, careful process development is recommended.

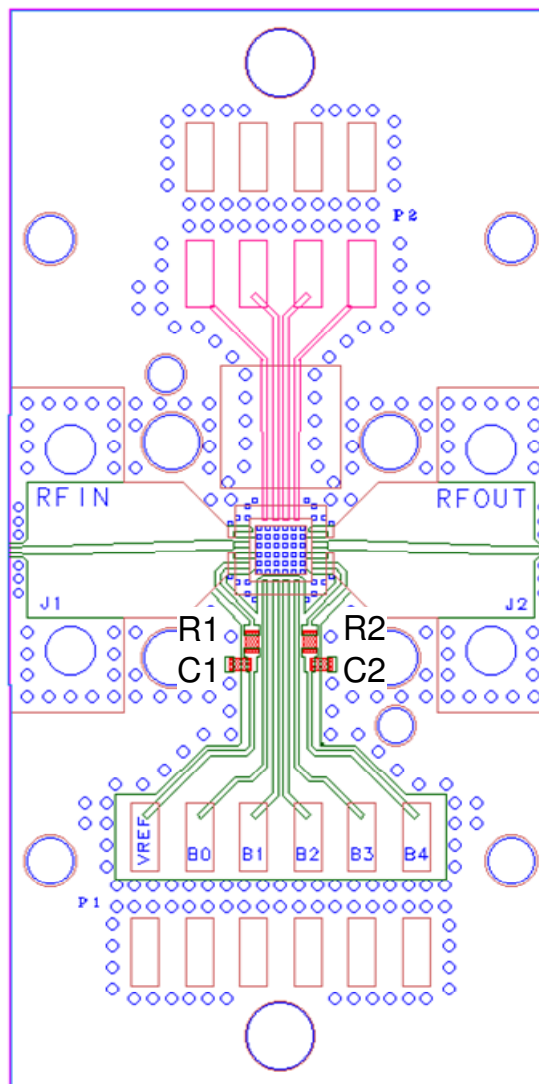

Bill of Materials

Ref. Designation	Value	Description	Mfg.	Part Number
R1, R2	180 Ohms	Resistor, 0402 case	Various	
C1, C2	0.5 pF	Cap., 50V, ± 0.1 pF, C0G, 0402 case	Murata	GJM1555C1HR50BB01

Mounting Detail

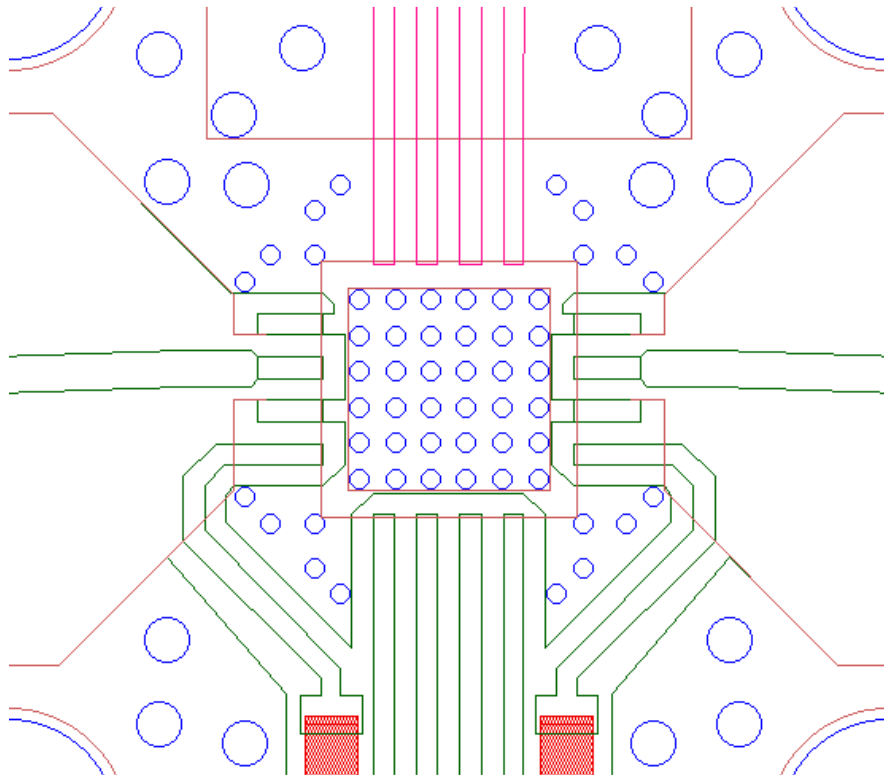

Note:

Multiple vias should be employed under package center paddle to minimize inductance and thermal resistance.

Mechanical Information

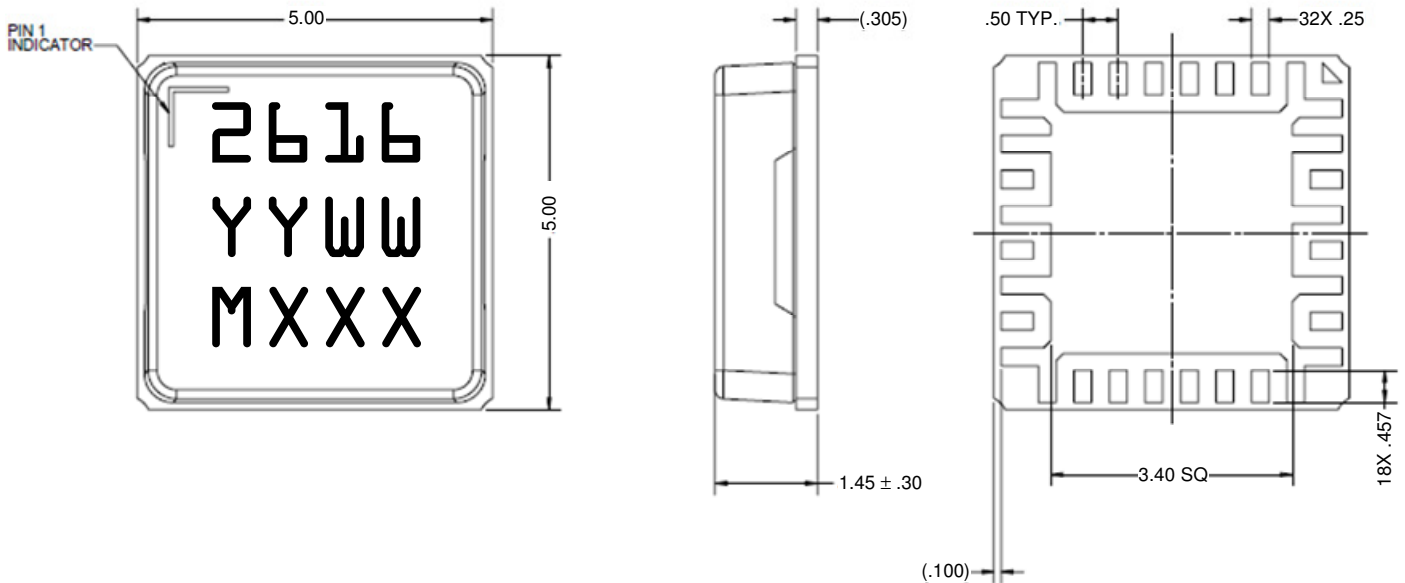

Dimensions are in mm.

The TGL2616-SM will be marked with the “YYWW” and “MXXX” designators and a lot code marked below the part designator. The “YY” represents the last two digits of the year the part was manufactured, the “WW” is the work week, and the “MXXX” is an auto-generated number.

This package is lead-free/RoHS-compliant. This package is compatible with both lead free and tin-lead soldering processes.

Dimensions are in millimeters.

Pad Description

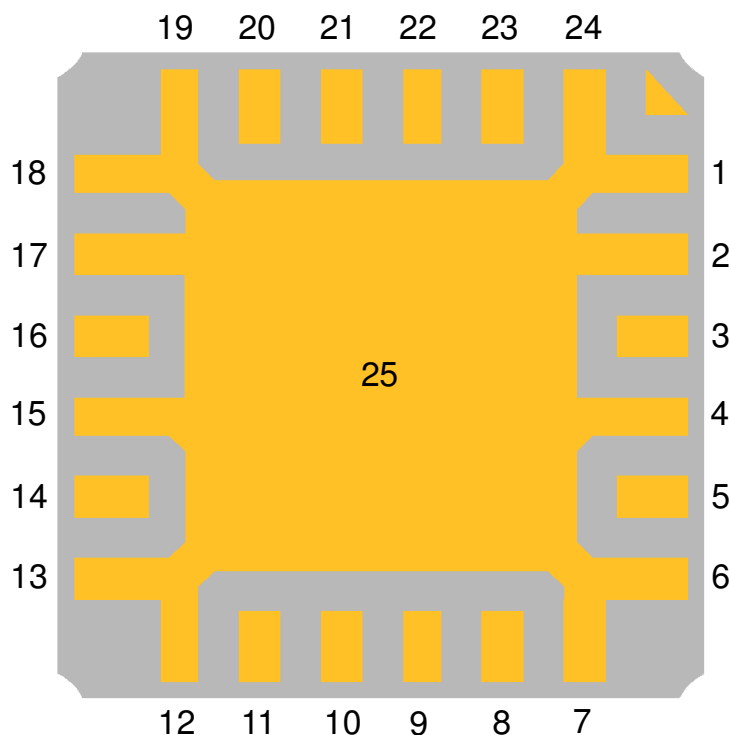

Bottom view of package base

Pin Number	Label	Description
3	RF Input	RF Input
16	RF Output	RF Output
14	B4 (12 dB bit)	Control line for Bit 4
11	B3 (6 dB bit)	Control line for Bit 3
10	B2 (3 dB bit)	Control line for Bit 2
9	B1 (1.5 dB bit)	Control line for Bit 1
8	B0 (0.75 dB bit)	Control line for Bit 0
5	V _{REF}	Reference Voltage
1,2,4,6,7,12,13,15,17,18,19,24,25	GND	Ground. On PCB, multiple vias should be employed under 25 (center pad) to minimize inductance and thermal resistance.
20-23		No connection

Recommended Soldering Temperature Profile

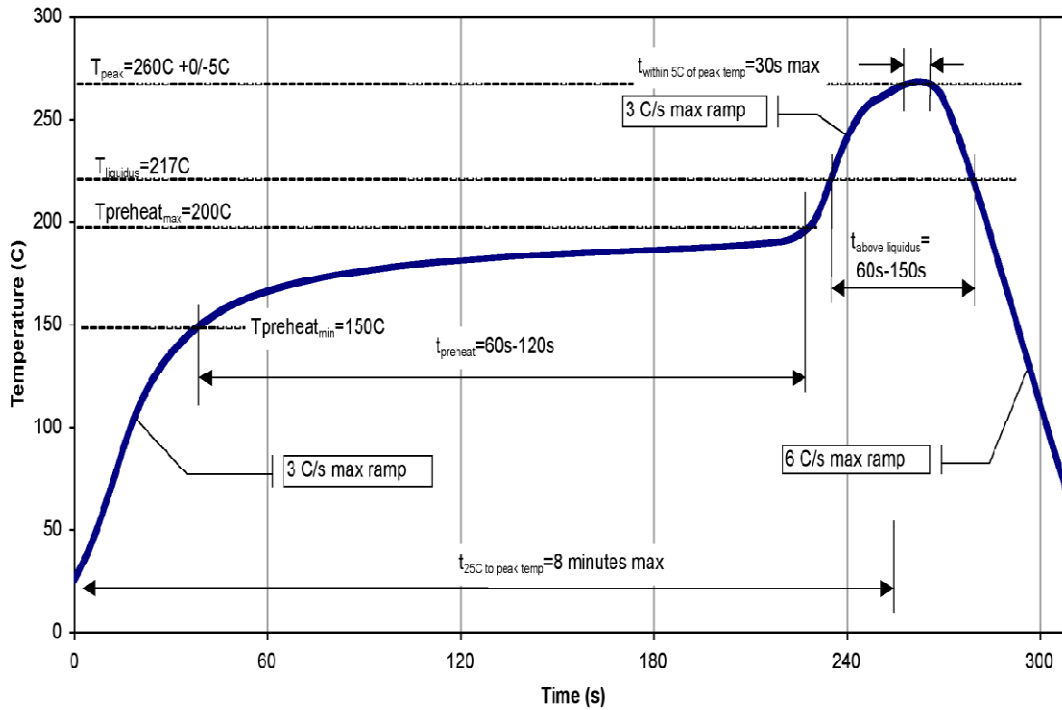

Product Compliance Information

ESD Sensitivity Ratings



Caution! ESD-Sensitive Device

ESD Rating: TBD
Value: TBD
Test: Human Body Model (HBM)
Standard: JEDEC Standard JESD22-A114

ECCN

US Department of Commerce: EAR99

Solderability

Compatible with the latest version of J-STD-020 Lead free solder, 260 °C.

RoHS-Compliance

This part is compliant with EU 2002/95/EC RoHS directive (Restrictions on the Use of Certain Hazardous Substances in Electrical and Electronic Equipment).

This product also has the following attributes:

- Lead Free
- Halogen Free (Chlorine, Bromine)
- Antimony Free
- TBBP-A (C15H12Br4O2) Free
- PFOS Free
- SVHC Free

Contact Information

For the latest specifications, additional product information, worldwide sales and distribution locations, and information about TriQuint:

Web: www.triquint.com
Email: info-sales@tqs.com

Tel: +1.972.994.8465
Fax: +1.972.994.8504

For technical questions and application information: Email: info-products@tqs.com

Important Notice

The information contained herein is believed to be reliable. TriQuint makes no warranties regarding the information contained herein. TriQuint assumes no responsibility or liability whatsoever for any of the information contained herein. TriQuint assumes no responsibility or liability whatsoever for the use of the information contained herein. The information contained herein is provided "AS IS, WHERE IS" and with all faults, and the entire risk associated with such information is entirely with the user. All information contained herein is subject to change without notice. Customers should obtain and verify the latest relevant information before placing orders for TriQuint products. The information contained herein or any use of such information does not grant, explicitly or implicitly, to any party any patent rights, licenses, or any other intellectual property rights, whether with regard to such information itself or anything described by such information.

TriQuint products are not warranted or authorized for use as critical components in medical, life-saving, or life-sustaining applications, or other applications where a failure would reasonably be expected to cause severe personal injury or death.