

# CM6305

## EMI Filter with ESD Protection for SIM Card Applications

### Product Description

The CM6305 is a 3 x 3, 8-bump EMI filter with ESD protection device for SIM card applications in a 0.4 mm pitch CSP form factor. It is fully compliant with IEC 61000-4-2. The CM6305 is also RoHS II compliant.



ON Semiconductor®

<http://onsemi.com>



WLCSP8  
CASE 567CE

### MARKING DIAGRAM

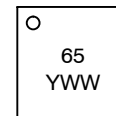

65 = CM6305  
YWW = Date Code

### ELECTRICAL SCHEMATIC

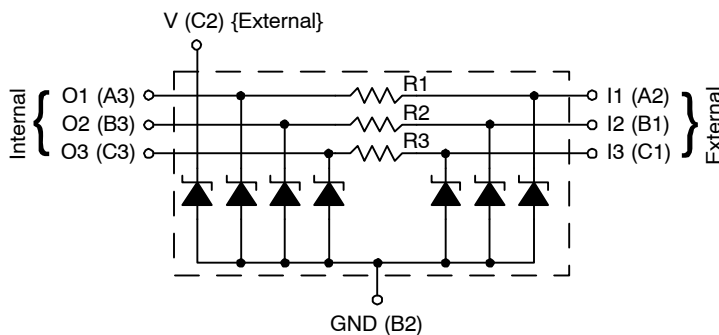

### PACKAGE / PINOUT DIAGRAMS

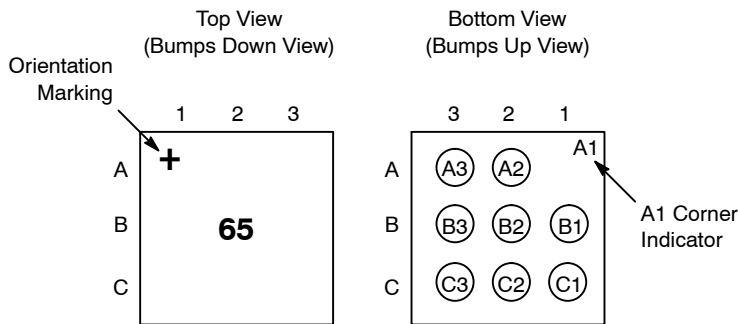

### ORDERING INFORMATION

Device	Package	Shipping†
CM6305	WLCSP-8 (Pb-Free)	5000/Tape & Reel

†For information on tape and reel specifications, including part orientation and tape sizes, please refer to our Tape and Reel Packaging Specification Brochure, BRD8011/D.

Table 1. PIN DESCRIPTIONS

Pin	Description	Pin	Description
A2	Channel 1 External	A3	Channel 1 Internal
B1	Channel 2 External	B3	Channel 2 Internal
C1	Channel 3 External	C3	Channel 3 Internal
B2	GND	C2	V External

# CM6305

## ELECTRICAL SPECIFICATIONS AND CONDITIONS

**Table 2. PARAMETERS AND OPERATING CONDITIONS**

Parameter	Rating	Units
Storage Temperature Range	-55 to +150	°C
Operating Temperature Range	-40 to +85	°C
Power Dissipation at 70°C per Channel	60	mW

**Table 3. ELECTRICAL OPERATING CHARACTERISTICS** (Note 1)

Symbol	Parameter	Conditions	Min	Typ	Max	Units
R <sub>1</sub>	Resistance		80	100	120	Ω
R <sub>2</sub>	Resistance		37.6	47	56.4	Ω
R <sub>3</sub>	Resistance		80	100	120	Ω
I <sub>LEAK</sub>	Leakage Current per Channel	V <sub>IN</sub> = 3.0 V		10	100	nA
C	Capacitance on Filter Channels 1, 2 and 3	At 1 MHz, V <sub>IN</sub> = 0 V	8	10	12	pF
	Capacitance on Clamp Channel (pin C2)	At 1 MHz, V <sub>IN</sub> = 0 V	8	10	12	pF
V <sub>B</sub>	Breakdown Voltage (Positive)	I <sub>R</sub> = 1 mA	6	7	9	V
V <sub>ESD</sub>	ESD Protection Peak Discharge Voltage at A2, B1 and C1 pins a) Contact Discharge per IEC 61000-4-2 standard b) Air Discharge per IEC 61000-4-2 standard	(Note 2)	±8 ±15			kV
	ESD Protection Peak Discharge Voltage at C2 pin a) Contact Discharge per IEC 61000-4-2 standard b) Air Discharge per IEC 61000-4-2 standard	(Note 2)	±15 ±15			kV
	ESD Protection Peak Discharge Voltage at A3, B3 and C3 pins a) Contact Discharge per IEC 61000-4-2 standard b) Air Discharge per IEC 61000-4-2 standard	(Note 2)	±2 ±2			kV

1. All parameters specified at T<sub>A</sub> = 25°C unless otherwise noted.
2. Standard IEC 61000-4-2 with C<sub>Discharge</sub> = 150 pF, R<sub>Discharge</sub> = 330 Ω.

**Table 4. CSP TAPE AND REEL SPECIFICATIONS** †

Part Number	Chip Size (mm)	Pocket Size (mm) B <sub>0</sub> X A <sub>0</sub> X K <sub>0</sub>	Tape Width W	Reel Dia.	Qty Per Reel	P <sub>0</sub>	P <sub>1</sub>
CM6305	1.16 X 1.16 X 0.60	1.27 X 1.27 X 0.69	8 mm	178 mm (7")	5000	4 mm	4 mm

†For information on tape and reel specifications, including part orientation and tape sizes, please refer to our Tape and Reel Packaging Specification Brochure, BRD8011/D.

# CM6305

## RF CHARACTERISTICS

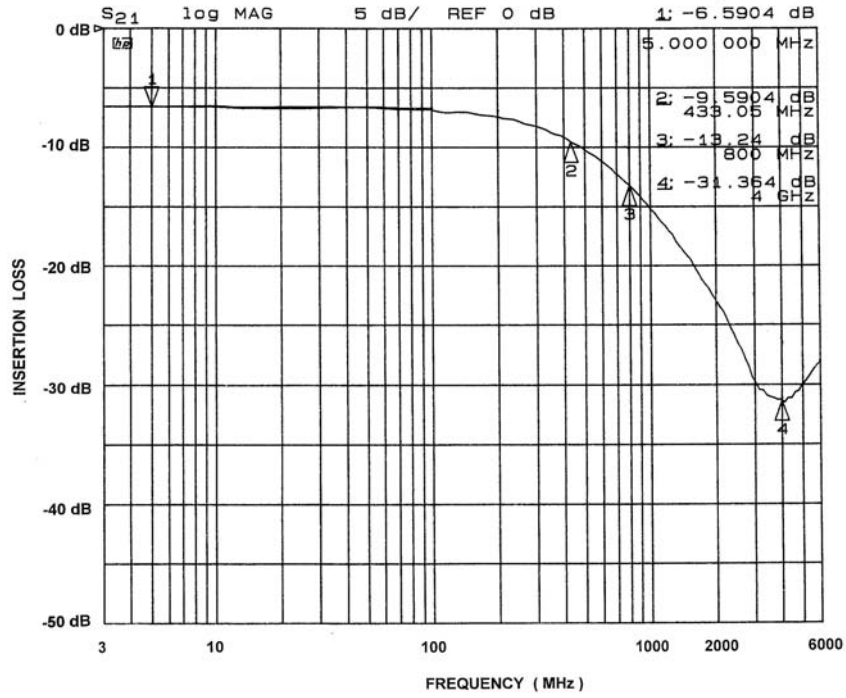

Figure 1. Insertion Loss, Filter 1 (pins A2, A3) and Filter 3 (pins C1, C3) (Bias = 0 V,  $T_A = 25^\circ\text{C}$ )

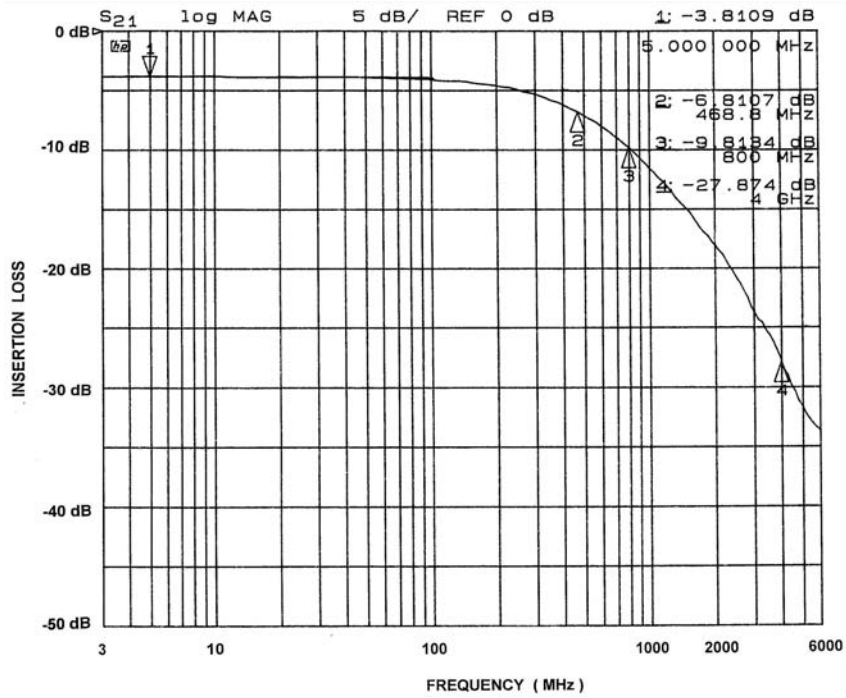
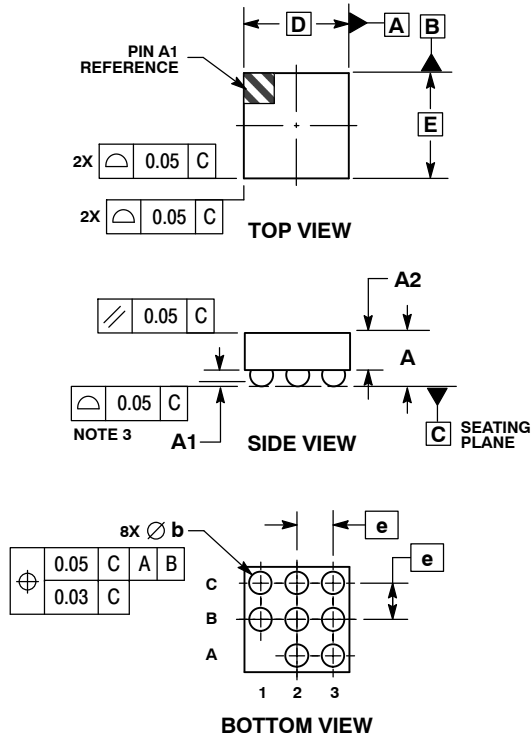

Figure 2. Insertion Loss, Filter 2 (pins B1, B3) (Bias = 0 V,  $T_A = 25^\circ\text{C}$ )

# CM6305

## PACKAGE DIMENSIONS

WLCSP8, 1.16x1.16  
CASE 567CE  
ISSUE O



- NOTES:
1. DIMENSIONING AND TOLERANCING PER ASME Y14.5M, 1994.
  2. CONTROLLING DIMENSION: MILLIMETERS.
  3. COPLANARITY APPLIES TO SPHERICAL CROWNS OF SOLDER BALLS.

DIM	MILLIMETERS	
	MIN	MAX
A	0.57	0.63
A1	0.17	0.24
A2	0.41	REF
b	0.24	0.29
D	1.16	BSC
E	1.16	BSC
e	0.40	BSC

### RECOMMENDED SOLDERING FOOTPRINT\*

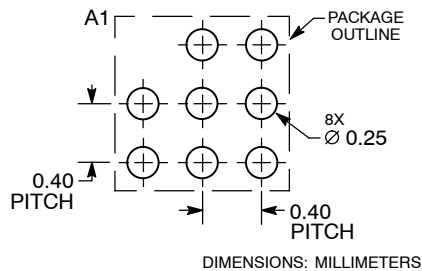

\*For additional information on our Pb-Free strategy and soldering details, please download the ON Semiconductor Soldering and Mounting Techniques Reference Manual, SOLDERRM/D.

ON Semiconductor and are registered trademarks of Semiconductor Components Industries, LLC (SCILLC). SCILLC reserves the right to make changes without further notice to any products herein. SCILLC makes no warranty, representation or guarantee regarding the suitability of its products for any particular purpose, nor does SCILLC assume any liability arising out of the application or use of any product or circuit, and specifically disclaims any and all liability, including without limitation special, consequential or incidental damages. "Typical" parameters which may be provided in SCILLC data sheets and/or specifications can and do vary in different applications and actual performance may vary over time. All operating parameters, including "Typicals" must be validated for each customer application by customer's technical experts. SCILLC does not convey any license under its patent rights nor the rights of others. SCILLC products are not designed, intended, or authorized for use as components in systems intended for surgical implant into the body, or other applications intended to support or sustain life, or for any other application in which the failure of the SCILLC product could create a situation where personal injury or death may occur. Should Buyer purchase or use SCILLC products for any such unintended or unauthorized application, Buyer shall indemnify and hold SCILLC and its officers, employees, subsidiaries, affiliates, and distributors harmless against all claims, costs, damages, and expenses, and reasonable attorney fees arising out of, directly or indirectly, any claim of personal injury or death associated with such unintended or unauthorized use, even if such claim alleges that SCILLC was negligent regarding the design or manufacture of the part. SCILLC is an Equal Opportunity/Affirmative Action Employer. This literature is subject to all applicable copyright laws and is not for resale in any manner.

### PUBLICATION ORDERING INFORMATION

**LITERATURE FULFILLMENT:**  
Literature Distribution Center for ON Semiconductor  
P.O. Box 5163, Denver, Colorado 80217 USA  
**Phone:** 303-675-2175 or 800-344-3860 Toll Free USA/Canada  
**Fax:** 303-675-2176 or 800-344-3867 Toll Free USA/Canada  
**Email:** orderlit@onsemi.com

**N. American Technical Support:** 800-282-9855 Toll Free  
USA/Canada  
**Europe, Middle East and Africa Technical Support:**  
Phone: 421 33 790 2910  
**Japan Customer Focus Center**  
Phone: 81-3-5773-3850

**ON Semiconductor Website:** [www.onsemi.com](http://www.onsemi.com)  
**Order Literature:** <http://www.onsemi.com/orderlit>  
For additional information, please contact your local Sales Representative