

# High Frequency Relay G6K-RF

## Surface Mount, 1GHz / 3 GHz Miniature DPDT, High Frequency Relay

- New Models with 3 GHz band available ("-T" versions)
- Space-saving 1 GHz version with smaller ground terminal footprint is available. ("-S" versions)
- Handles 1 A, 30 VDC discrete load and 1 W at 1GHz.
- Single-coil latching models available.
- Low coil power consumption: 100 mW.
- Ideal for instrumentation and high-speed LAN network equipment.
- RoHS Compliant

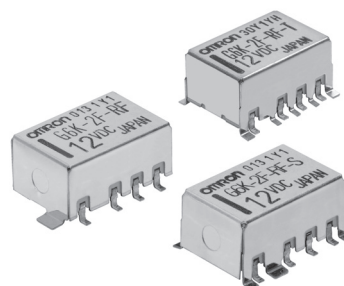

**NEW**

## Ordering Information

PCB Footprint	Max.Load	Coil Voltage	Non-Latching part number	Single-coil latching part number
Standard ground terminal (1GHz)	1 A at 30 VDC, 0.3 A at 125 VDC	3 VDC	G6K-2F-RF DC3	G6KU-2F-RF DC3
		4.5 VDC	G6K-2F-RF DC4.5	G6KU-2F-RF DC4.5
		5 VDC	G6K-2F-RF DC5	G6KU-2F-RF DC5
		12 VDC	G6K-2F-RF DC12	G6KU-2F-RF DC12
		24 VDC	G6K-2F-RF DC24	G6KU-2F-RF DC24
Space-saving ground terminal (1 GHz)		3 VDC	G6K-2F-RF-S DC3	G6KU-2F-RF-S DC3
		4.5 VDC	G6K-2F-RF-S DC4.5	G6KU-2F-RF-S DC4.5
		5 VDC	G6K-2F-RF-S DC5	G6KU-2F-RF-S DC5
		12 VDC	G6K-2F-RF-S DC12	G6KU-2F-RF-S DC12
		24 VDC	G6K-2F-RF-S DC24	G6KU-2F-RF-S DC24
Space-saving ground terminal (3GHz)		3 VDC	G6K-2F-RF-T DC3	G6KU-2F-RF-T DC3
		4.5 VDC	G6K-2F-RF-T DC4.5	G6KU-2F-RF-T DC4.5
		5 VDC	G6K-2F-RF-T DC5	G6KU-2F-RF-T DC5
		12 VDC	G6K-2F-RF-T DC12	G6KU-2F-RF-T DC12
		24 VDC	G6K-2F-RF-T DC24	G6KU-2F-RF-T DC24

**Note:** The above listed models are packaged in trays of 300. They are also available in Tape and Reel packaging.

1. Place "-TR03" before the coil voltage to obtain Tape and Reel packaging, in quantities of 300 pieces per reel.
2. Place "-TR09" before the coil voltage to obtain Tape and Reel packaging, in quantities of 900 pieces per reel.

Examples: G6K-2F-RF-S-TR09 DC5  
G6KU-2F-RF-TR03 DC12

3. "-TR03" and "-TR09" is only used to identify the tape quantity when ordering and is not marked on the product, itself.

## Specifications

### ■ Contact Ratings

Load	Resistive load
<b>Rated load</b>	0.3 A at 125 VAC; 1 A at 30 VDC 1 W at 1 GHz (See note.)
<b>Rated carry current</b>	1 A
<b>Max. switching voltage</b>	125 VAC, 60 VDC
<b>Max. switching current</b>	1 A
<b>Max. switching capacity</b>	37.5 VA (AC); 30 W (DC)

**Note:** This value is for a load with V.S.W.R. ≤ 1.2

## ■ Coil Ratings

Rated voltage	Rated current	Coil resistance	Must operate voltage	Must release voltage	Maximum voltage	Rated power consumption
3 VDC	33.0 mA	91 Ω	80% max. of rated voltage	10% min. of rated voltage	150% of rated voltage	Approx. 100 mW
4.5 VDC	23.2 mA	194 Ω				
5 VDC	21.1 mA	237 Ω	(75% max. of rated set voltage for latching models)	(75% max. of rated reset voltage for latching models)		
12 VDC	9.1 mA	1,315 Ω				
24 VDC	4.6 mA	5,220 Ω				

- Note:**
1. The rated current and coil resistance are measured at a coil temperature of 23°C with a tolerance of ±10%.
  2. The operating characteristics are measured at a coil temperature of 23°C.
  3. The maximum voltage is the highest voltage that can be imposed on the Relay coil instantaneously.

## ■ High Frequency Characteristics

		1 GHz, all models	3 GHz, “-T” models
Isolation	between contacts of the same pole	20 dB min.	18 dB min.
	between contacts of different poles	30 dB min.	25 dB min.
Insertion loss		0.2 dB max.	0.6 dB max.
V.S.W.R.		1.2 max.	1.4 max.
Maximum transmission capacity		3 W (See note 3)	
Maximum switching capacity		1 W (See note 3)	

- Note:**
1. The impedance of the measurement system is 50 Ω.
  2. The above values are initial
  3. These values are for a load with V.S.W.R. ≤ 1.2
  4. Contact Omron if the relay will be used in an application that requires high repeatability in high-frequency characteristics for the microload region. (Such applications include Test and Measurement equipment and ATE applications.)

## ■ Characteristics

Item	Single-side stable models		Single-winding latching models	
	G6K-2F-RF(-S)(-T)		G6KU-2F-RF(-S)(-T)	
<b>Contact resistance (See note 2.)</b>	100 mΩ max.			
<b>Operating (set) time (See note 3.)</b>	3 ms max. (approx. 1.4 ms)		3 ms max. (approx. 1.2 ms)	
<b>Release (reset) time (See note 3.)</b>	3 ms max. (approx. 1.3 ms)		3 ms max. (approx. 1.2 ms)	
<b>Minimum set/reset pulse time</b>	---		10 ms	
<b>Insulation resistance (See note 4.)</b>	1,000 MΩ min. (at 500 VDC)			
<b>Dielectric strength</b>	<b>Between coil and contacts</b>	750 VAC, 50/60 Hz for 1 min		
	<b>Between contacts of different poles</b>	750 VAC, 50/60 Hz for 1 min		
	<b>Between contacts of the same pole</b>	750 VAC, 50/60 Hz for 1 min		
	<b>Between ground and coil/contacts</b>	500 VAC, 50/60 Hz for 1 min		
<b>Vibration resistance</b>	<b>Destruction</b>	10 to 55 Hz, 5-mm double amplitude and 55 to 500 to 55 Hz, 300 m/s <sup>2</sup>		
	<b>Malfunction</b>	10 to 55 Hz, 3.3-mm double amplitude and 55 to 500 to 55 Hz, 200 m/s <sup>2</sup>		
<b>Shock resistance</b>	<b>Destruction</b>	1,000 m/s <sup>2</sup>		
	<b>Malfunction</b>	750 m/s <sup>2</sup>		
<b>Endurance</b>	<b>Mechanical</b>	50,000,000 operations min. (at a switching frequency of 36,000 operations/hour)		
	<b>Electrical</b>	100,000 operations min. (at a switching frequency of 1,800 operations/hour)		
<b>Ambient operating temperature</b>	Operating: -40°C to 70°C (with no icing or condensation)			
<b>Ambient operating humidity</b>	Operating: 5% to 85%			
<b>Weight</b>	Approx. 0.95 g			

- Note:**
1. The above values are initial values.
  2. The contact resistance was measured with 10 mA at 1 VDC with a voltage drop method.
  3. Values in parentheses are typical values.
  4. The insulation resistance was measured with a 500-VDC megohmmeter applied to the same parts as those used for checking the dielectric strength.

# Engineering Data

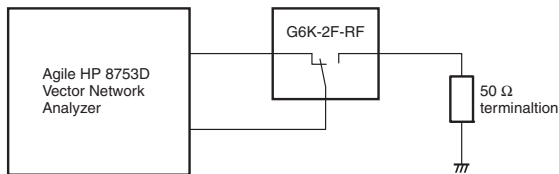

## High-Frequency Characteristics (Isolation)

### G6K-2F-RF

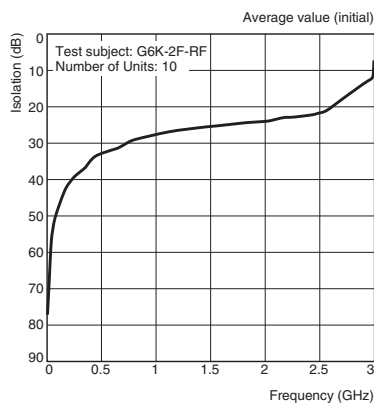

## High-frequency Characteristics (Insertion Loss)

### G6K-2F-RF

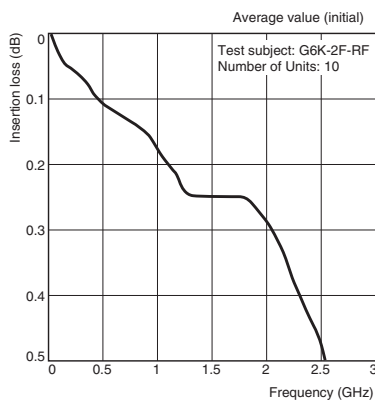

## High-frequency Characteristics (Return Loss, V.S.W.R.)

### G6K-2F-RF

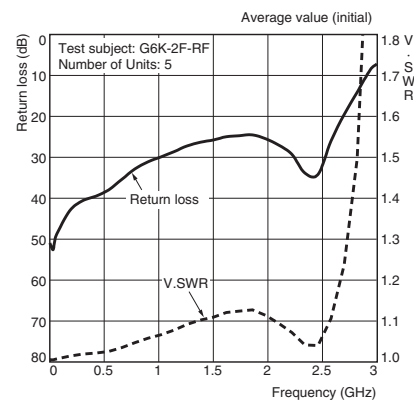

### G6K-2F-RF-S

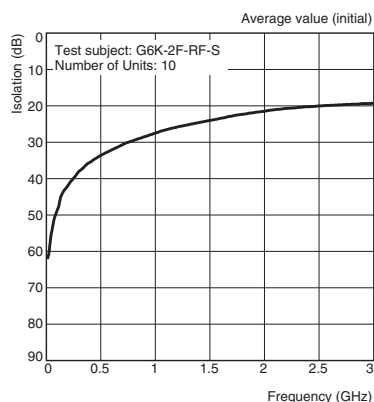

### G6K-2F-RF-S

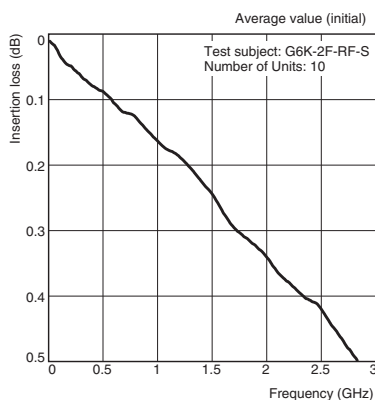

### G6K-2F-RF-S

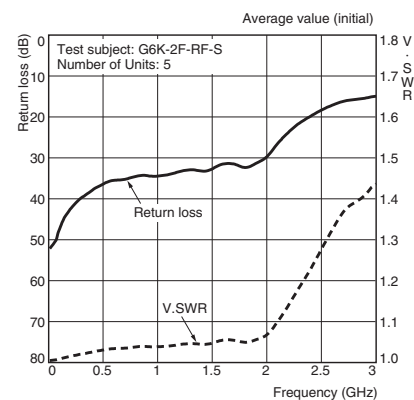

### G6K-2F-RF-T

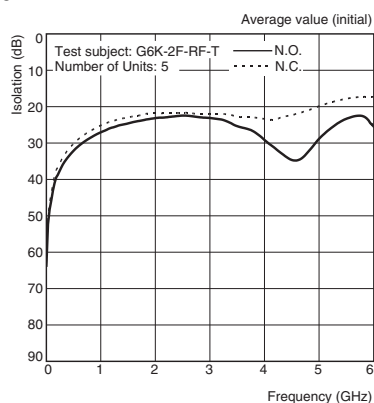

### G6K-2F-RF-T

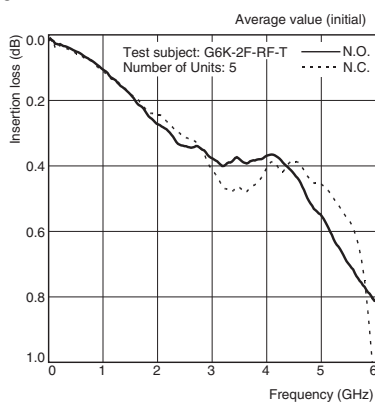

### G6K-2F-RF-T

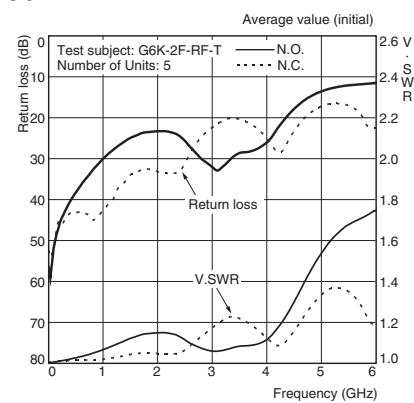

**Note:** 1. Refer to the G6K specification for basic specifications and characteristics not shown above

2. Ambient temperature condition: 23°C

3. The high-frequency characteristics depend on the mounting board. Be sure to check actual operation, including durability, in actual equipment before use.

# Dimensions

Note: All dimensions are in millimeters unless otherwise indicated

## G6K-2F-RF G6KU-2F-RF

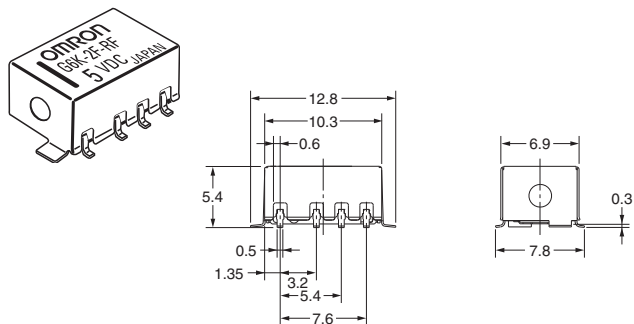

Note: 1. Each value has a tolerance of  $\pm 0.3$  mm  
2. The coplanarity of the terminals is 0.15 mm max.

## Mounting Dimensions (Top View)

Tolerance  $\pm 0.1$  mm

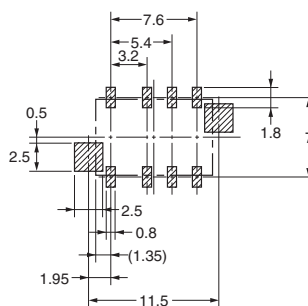

Note: Check carefully the coil polarity of the relay

## Terminal Arrangement and Internal Connections (Top View)

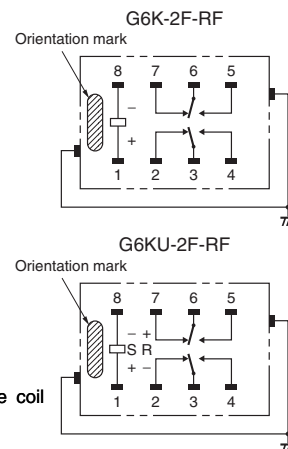

## G6K-2F-RF-S G6KU-2F-RF-S

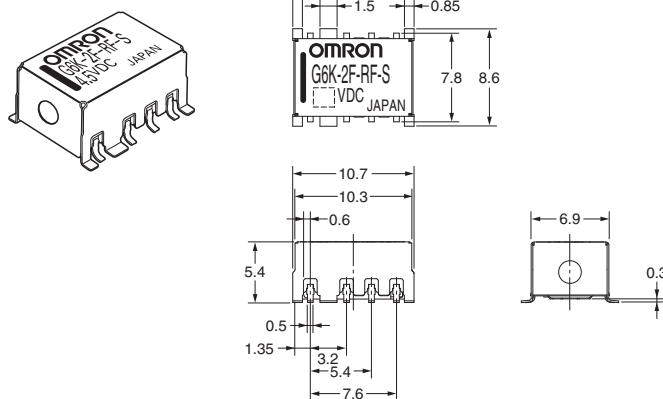

Note: 1. Each value has a tolerance of  $\pm 0.3$  mm  
2. The coplanarity of the terminals is 0.15 mm max.

## Mounting Dimensions (Top View)

Tolerance  $\pm 0.1$  mm

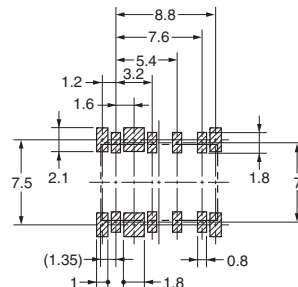

Note: Check carefully the coil polarity of the relay

## Terminal Arrangement and Internal Connections (Top View)

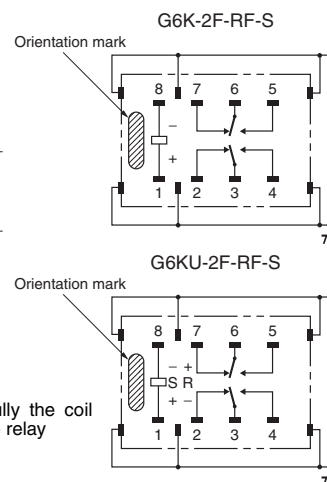

## G6K-2F-RF-T G6KU-2F-RF-T

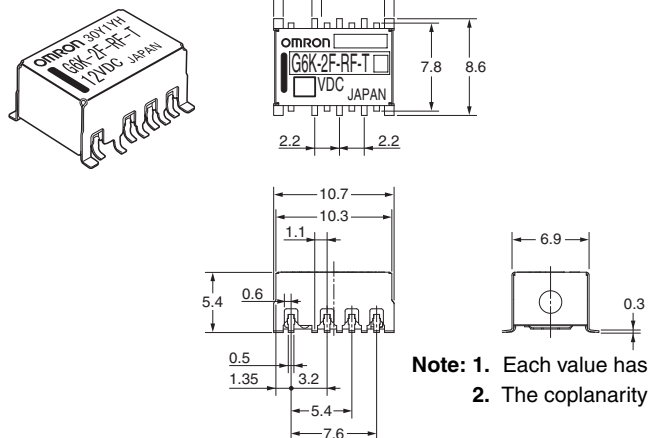

Note: 1. Each value has a tolerance of  $\pm 0.3$  mm  
2. The coplanarity of the terminals is 0.15 mm max.

## Mounting Dimensions (Top View)

Tolerance  $\pm 0.1$  mm

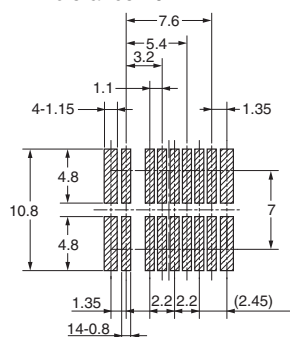

Note: Check carefully the coil polarity of the relay

## Terminal Arrangement and Internal Connections (Top View)

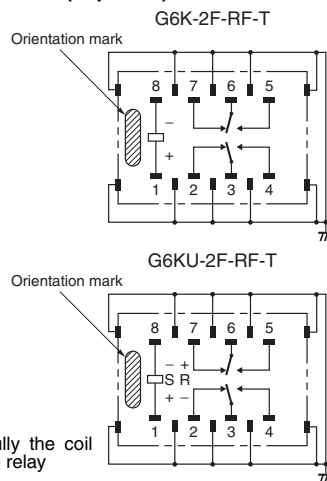

# Tape Packaging Specifications

- Add “-TR03” or “-TR09” before the coil voltage to order relays in Tape and Reel packaging. If “-TR03” or “-TR09” is not included, then the relays will be provided in trays of 300 relays per tray.
  - - Add “-TR03” to obtain 300 relays per reel
  - - Add “-TR09” to obtain 900 relays per reel

## 1. Direction of Relay insertion

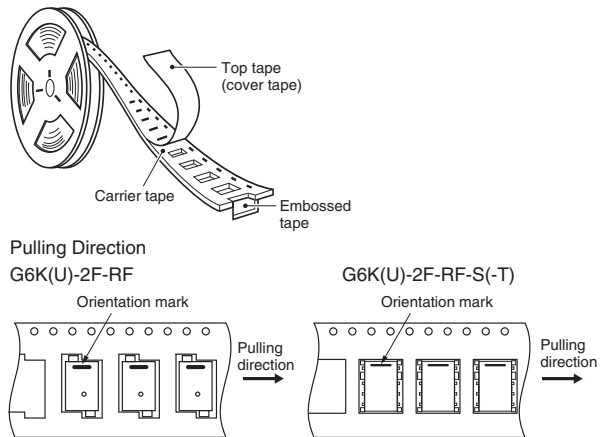

## 2. Reel Dimensions

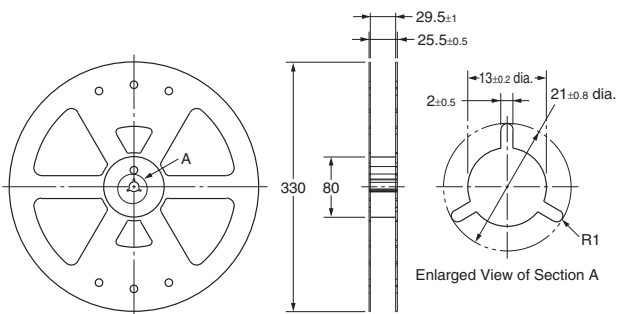

## 3. Carrier Tape Dimensions

### G6K(U)-2F-RF

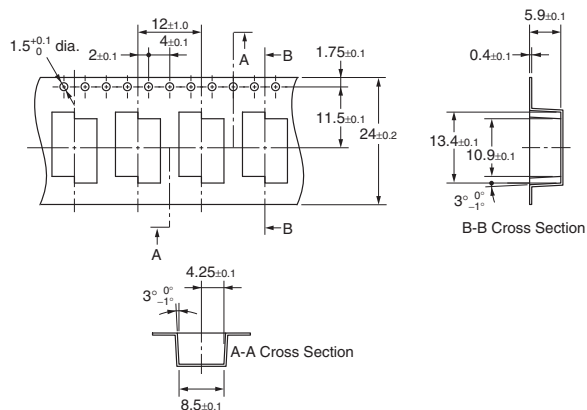

### G6K(U)-2F-RF-S

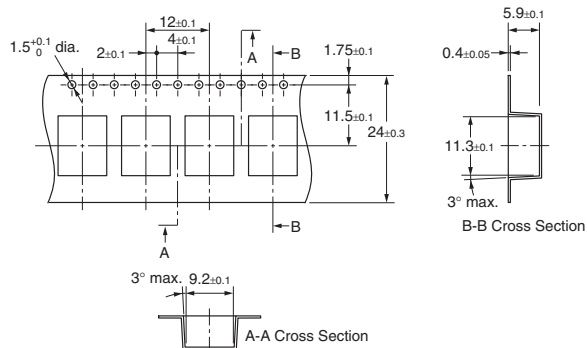

# Precautions

## ■ Recommended Soldering Method

### 1. Temperature Profile for Lead Solder (Measured at the PCB)

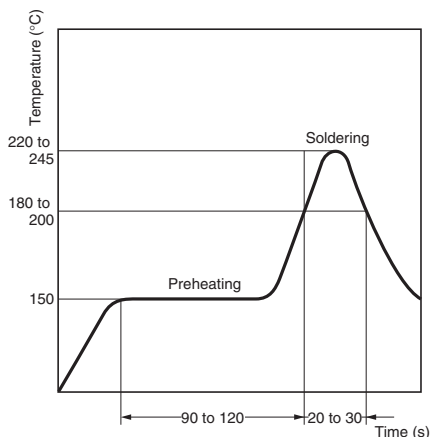

### 2. Temperature Profile for Lead-free Solder (Measured at the PCB)

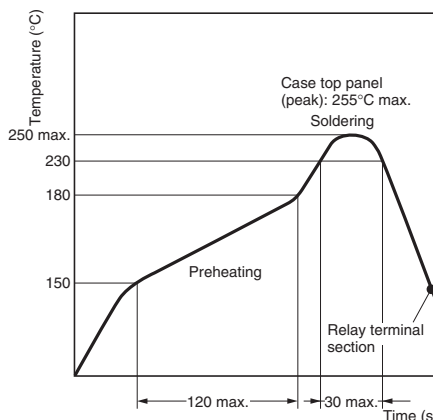

3. The thickness of cream solder to be applied should be between 200 and 250  $\mu\text{m}$  and the land pattern should be based on Omron's recommended PCB pattern. To maintain the correct soldering joint shown in the following diagram, we recommend applying solder using the soldering conditions shown above. Check the soldering in the actual mounting conditions prior to use.

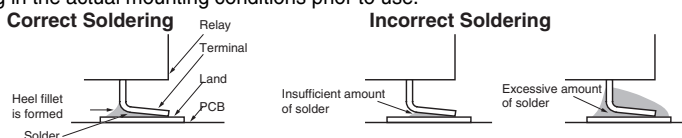

## ■ Precautions for correct use

Be sure to read the precautions and information common to all Electromechanical Relays, contained in the Technical User's Guide, "Electromechanical Relays, Technical Information, for correct use.

### Relay Handling

Do not unpack the relay until ready to mount it. Use the relay as soon as possible after opening the moisture-proof bag. Otherwise, the terminals may tarnish and seal failure may occur after the solder process.

When washing the product after soldering, use a water-based or alcohol-based solvent. Keep the solvent temperature below 40°C. Do not put the relay in a cold cleaning bath immediately after soldering.

### Operating, Storage Environment

If the relay is stored for a long time in an adverse environment with high temperature, high humidity, organic or sulfide gases, then sulfide or oxide films will form on the contact surfaces. These films may result in unstable contact, contact problems or function problems. Therefore, operate, store or transport the product under specified environmental conditions.

1. Use in locations where the relay is not exposed to corrosive gas such as hydrogen sulfide gas or salty air.
2. Use in locations where no visible dust exists.
3. Use, store and transport in locations where the product is not exposed to direct sunlight, rain or snow.
4. Do not apply force to the product which may result in deformation or change in quality of the product.

### Coating

The relay mounted on the PCB may be coated or washed, but do not apply silicone coating or detergent containing silicone, otherwise, the silicone coating or detergent may remain on the surface of the relay.

### Latching Relay Mounting

Make sure that excess vibration or shock doesn't set or reset the relay during normal operation. The relay is shipped in the 'reset' position. Shock or vibration during shipping may require the application of a reset signal, prior to operation.

### Claw Securing Force During Automatic Mounting

During automatic insertion of relays, make sure to set the securing force of each claw to the following so that the relay's characteristics will be maintained.

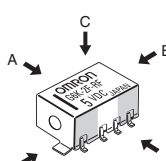

- Direction A: 1.96 N max.
- Direction B: 4.90 N max.
- Direction C: 1.96 N max.

Secure the claws to the shaded area. Do not attach them to the center of the relay or just one part of the relay.

### Maximum Allowable Voltage

The maximum allowable voltage of the coil can be obtained from the coil temperature increase and the heat-resisting temperature of the coil insulating sheath material. (Exceeding the heat-resisting temperature may result in burning or short-circuiting.) The maximum allowable voltage also involves important restrictions which include the following;

- Must not cause thermal changes in or deterioration of the insulating material, which may result in films developing on the contacts.
- Must not cause damage to other control devices.
- Must not cause any harmful effect on people.
- Must not cause fire.

Therefore, be sure to use the maximum allowable voltage as specified in the catalog. As a rule, the rated voltage must be applied to the coil. Consider using a latching relay instead of a non-latching relay with a continuous voltage applied to the coil.

### Long-term, Continuous ON contacts

Using the relay where it will remain continuously energized for long periods of time can lead to unstable contacts. We recommend using a latching relay for this type of application.

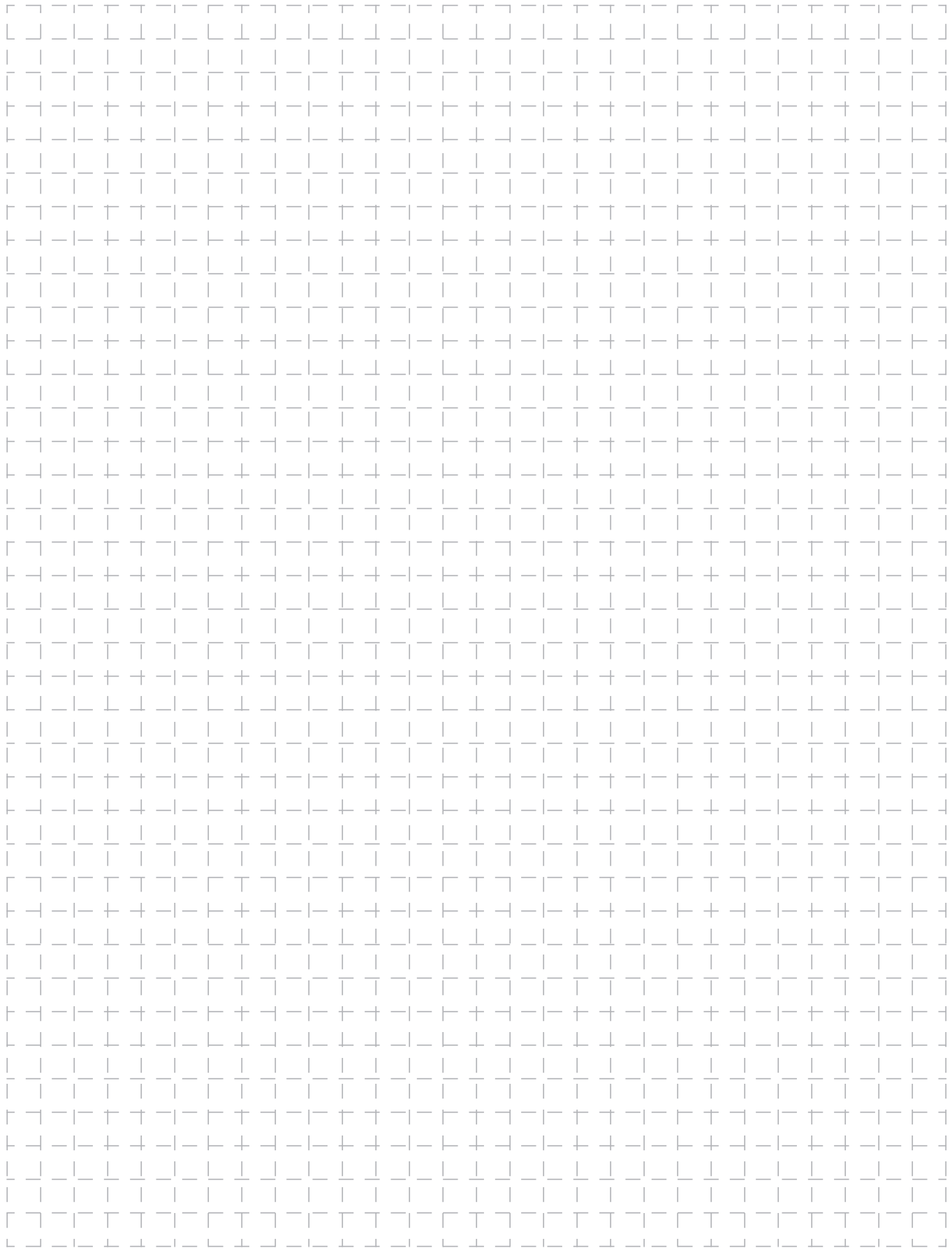

All sales are subject to Omron Electronic Components LLC standard terms and conditions of sale, which can be found at [http://www.components.omron.com/components/web/webfiles.nsf/sales\\_terms.html](http://www.components.omron.com/components/web/webfiles.nsf/sales_terms.html)

**ALL DIMENSIONS SHOWN ARE IN MILLIMETERS.**

To convert millimeters into inches, multiply by 0.03937. To convert grams into ounces, multiply by 0.03527.

---

**OMRON**<sup>®</sup>  
**OMRON ELECTRONIC  
COMPONENTS LLC**  
**847-882-2288**

**OMRON ON-LINE**

Global - <http://www.omron.com>

USA - <http://www.components.omron.com>

Cat. No. K242-E-02

06/14 (01/12)

Specifications subject to change without notice

Printed in USA