



SAW Components

SAW Duplexer

Automotive telematics

Series/type:	B4401
Ordering code:	B39941B4401P810
Date:	June 13, 2014
Version:	2.3

© EPCOS AG 2015. Reproduction, publication and dissemination of this publication, enclosures hereto and the information contained therein without EPCOS' prior express consent is prohibited.

EPCOS AG is a TDK Group Company.

Data sheet

Application

- Low-loss SAW duplexer for W-CDMA Band VIII systems
- Low insertion attenuation
- Low amplitude ripple
- Usable passband 35 MHz
- Single-ended to balanced transformation in Antenna-Rx path
- Impedance transformation 50 Ω to 100 Ω in Antenna-Rx path
- High isolation between Tx and Rx

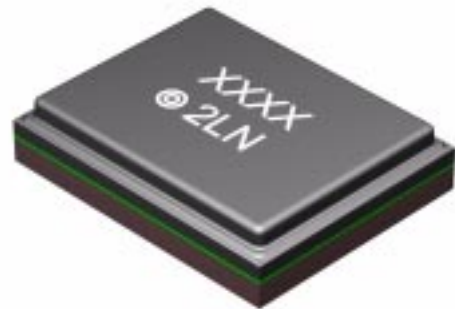
Features

- Package size 2.0 * 1.6 mm²
- Package height max. 0.45mm
- RoHS compatible
- Approximate weight 0.005 g
- Package for **Surface Mount Technology (SMT)**
- Ni terminals, Au-plated
- **Electrostatic Sensitive Device (ESD)**
- AEC-Q200 qualified component family (operable temperature range -40°C to +85°C)

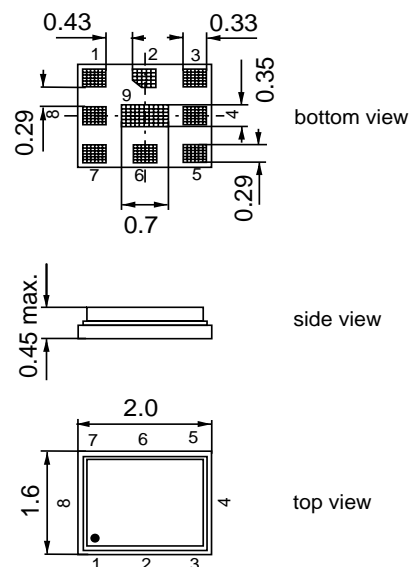
Pin configuration

- 3 Tx input
- 6 Antenna
- 1, 8 Rx output, balanced
- 2, 4, 5, 7, 9 To be grounded

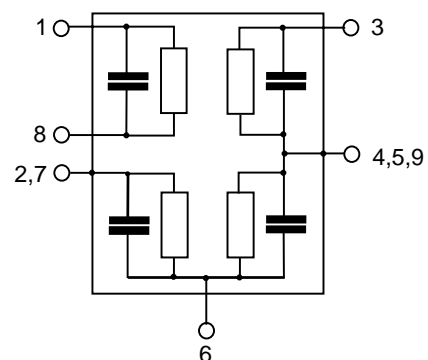

Data sheet

Characteristics

Temperature range for specification:	T = -20 °C to +85 °C
ANT terminating impedance:	Z _{ANT} = 50 Ω 7.8nH
TX terminating impedance:	Z _{TX} = 50 Ω 25nH
RX terminating impedance:	Z _{RX} = 100 Ω 39nH (balanced)

Characteristics Tx - Ant		min.	typ. @ 25 °C	max.	
Center frequency	f _C	—	897.5	—	MHz
Maximum insertion attenuation					
@f _{Carrier}	882.4 ... 912.6 MHz	—	1.8	2.8	dB
	880.0 ... 915.0 MHz	—	2.4	3.9	dB
	880.0 ... 915.0 MHz	—	2.4	2.8 ²⁾	dB
Amplitude ripple (p-p)					
@f _{Carrier}	882.4 ... 912.6 MHz	—	1.0	2.0	dB
	880.0 ... 915.0 MHz	—	1.6	3.1	dB
Error Vector Magnitude					
@f _{Carrier}	882.4 ... 912.6 MHz	—	2.3	6.0	%
@f _{Carrier}	882.4 ... 912.6 MHz	—	2.3	4.0 ²⁾	%
VSWR					
TX port	880.0 ... 915.0 MHz	—	1.8	2.1	
ANT port	880.0 ... 915.0 MHz	—	1.7	2.0	
Attenuation					
	50.0 ... 716.0 MHz	30	34	—	dB
	716.0 ... 728.0 MHz	30	34	—	dB
	728.0 ... 865.0 MHz	30	34	—	dB
	865.0 ... 870.0 MHz	10	41	—	dB
@f _{Carrier}	927.4 ... 957.6 MHz	38	53	—	dB
@f _{Carrier}	927.4 ... 957.6 MHz	45 ⁴⁾	53	—	dB
	1452.0 ... 1477.0 MHz	20	42	—	dB
	1565.42 ... 1573.374MHz	40	48	—	dB
	1573.374... 1577.466MHz	40	49	—	dB
	1577.466... 1585.42 MHz	40	49	—	dB
	1597.55 ... 1605.89 MHz	40	49	—	dB

1) Attenuation of WCDMA signal ("Powertransferfunction"). Please refer to annotation on page (7).

2) T = +25 °C

3) Error Vector Magnitude (EVM) based on definition given in 3GPP TS 25.141.

4) T = +5 °C to +85 °C

Data sheet

Characteristics

Temperature range for specification:	T = -20 °C to +85 °C
ANT terminating impedance:	Z _{ANT} = 50 Ω 7.8nH
TX terminating impedance:	Z _{TX} = 50 Ω 25nH
RX terminating impedance:	Z _{RX} = 100 Ω 39nH (balanced)

Characteristics Tx - Ant	min.	typ. @ 25 °C	max.	
1670.0 ... 1675.0 MHz	25	51	—	dB
1760.0 ... 1830.0 MHz	38	46	—	dB
1830.0 ... 1880.0 MHz	27	45	—	dB
2110.0 ... 2170.0 MHz	27	40	—	dB
2400.0 ... 2500.0 MHz	30	36	—	dB
2620.0 ... 2650.0 MHz	27	31	—	dB
2650.0 ... 2745.0 MHz	30	35	—	dB
3520.0 ... 3660.0 MHz	20	32	—	dB
4400.0 ... 4575.0 MHz	20	32	—	dB
5100.0 ... 5490.0 MHz	15	24	—	dB
5490.0 ... 5850.0 MHz	10	17	—	dB
Characteristics Tx - Rx	min.	typ. @ 25 °C	max.	
Differential Mode Isolation				
@f _{Carrier} 882.4 ... 912.6 MHz α _{WCDMA} ¹⁾	56	60	—	dB
@f _{Carrier} 927.4 ... 957.6 MHz α _{WCDMA} ¹⁾	43	57	—	dB
@f _{Carrier} 927.4 ... 957.6 MHz α _{WCDMA} ¹⁾	50 ²⁾	57	—	dB
Common Mode Isolation				
@f _{Carrier} 882.4 ... 912.6 MHz α _{WCDMA} ¹⁾	55	65	—	dB

1) Attenuation of WCDMA signal ("Powertransferfunction"). Please refer to annotation on page (7).

2) T= +5°C to +85°C

Data sheet

Characteristics

Temperature range for specification:	T = -20 °C to +85 °C
ANT terminating impedance:	Z _{ANT} = 50 Ω 7.8nH
TX terminating impedance:	Z _{TX} = 50 Ω 25nH
RX terminating impedance:	Z _{RX} = 100 Ω 39nH (balanced)

Characteristics Rx - Ant		min.	typ. @ 25 °C	max.	
Center frequency	f _C	—	942.5	—	MHz
Maximum insertion attenuation					
@f _{Carrier} 927.4 ... 957.6 MHz	α _{WCDMA} ¹⁾	—	1.8	2.5	dB
925.0 ... 960.0 MHz		—	2.4	4.7	dB
925.0 ... 960.0 MHz		—	2.4	3.2 ²⁾	dB
925.0 ... 960.0 MHz		—	2.4	3.7 ³⁾	dB
Amplitude ripple (p-p)					
@f _{Carrier} 927.4 ... 957.6 MHz	Δα _{WCDMA} ¹⁾	—	0.6	1.3	dB
925.0 ... 960.0 MHz		—	1.0	3.5	dB
Error Vector Magnitude					
@f _{Carrier} 927.4 ... 957.6 MHz	EVM ⁴⁾	—	3.3	8.5	%
@f _{Carrier} 927.4 ... 957.6 MHz	EVM ⁴⁾	—	3.3	4.5 ²⁾	%
VSWR					
RX port 925.0 ... 960.0 MHz		—	1.8	2.1	
ANT port 925.0 ... 960.0 MHz		—	1.7	2.0	
Common Mode Rejection Ratio	α				
925.0 ... 960.0 MHz		23	30		dB
Attenuation	α				
50.0 ... 462.0 MHz		35	90	—	dB
462.0 ... 480.0 MHz		45	86	—	dB
480.0 ... 835.0 MHz		38	68	—	dB
835.0 ... 870.0 MHz		49	65	—	dB
870.0 ... 880.0 MHz		38	67	—	dB
@f _{Carrier} 882.4 ... 912.6 MHz	α _{WCDMA} ¹⁾	50	57	—	dB
980.0 ... 1045.0 MHz		16	20	—	dB
1045.0 ... 2400.0 MHz		35	57	—	dB

1) Attenuation of WCDMA signal ("Powertransferfunction"). Please refer to annotation on page (7).

2) T= +25°C

3) T= +5°C to +85°C

4) Error Vector Magnitude (EVM) based on definition given in 3GPP TS 25.141.

Data sheet

Characteristics

Temperature range for specification:	T = -20 °C to +85 °C
ANT terminating impedance:	Z _{ANT} = 50 Ω 7.8nH
TX terminating impedance:	Z _{TX} = 50 Ω 25nH
RX terminating impedance:	Z _{RX} = 100 Ω 39nH (balanced)

Characteristics Rx - Ant		min.	typ. @ 25 °C	max.	
Center frequency	f _C	—	942.5	—	MHz
Attenuation	α				
	2400.0 ... 2500.0 MHz	45	60	—	dB
	2500.0 ... 4810.0 MHz	35	55	—	dB
	5100.0 ... 5825.0 MHz	35	52	—	dB

Maximum ratings

Operable temperature range ¹⁾	T	-40/+85	°C	
Storage temperature range	T _{stg}	-40/+85	°C	
DC voltage	V _{DC}	0	V	
Input power at 880.0 ... 915.0 MHz elsewhere	P _{IN}	30 10	dBm dBm	} WCDMA signal 55 °C, 10000 h

1) Defines the temperature range in which the SAW device keeps its typical characteristics, however the specification values are not guaranteed.

Annotation for characteristics section

Attenuation of WCDMA signal ("Powertransferfunction", α_{WCDMA}) is determined by

$$\int_{-\infty}^{\infty} |S_{\text{ds21}}(f)H_{\text{RRC}}(f - f_{\text{Carrier}})|^2 df$$

f_{Carrier} according to 3GPP TS 25.101 (e.g. for UMTS-Passband, f_{Carrier} ranges from 2112.4 MHz (lowest Rx channel) to 2167.6 MHz (highest Rx channel)). $H_{\text{RRC}}(f)$ is the transfer function of the root-raised cosine transmit pulse shaping filter according to 3GPP TS 25.101 with the following normalization:

$$\int_{-\infty}^{\infty} |H_{\text{RRC}}(f)|^2 df = 1$$

Data sheet



Frequency Response TX-ANT

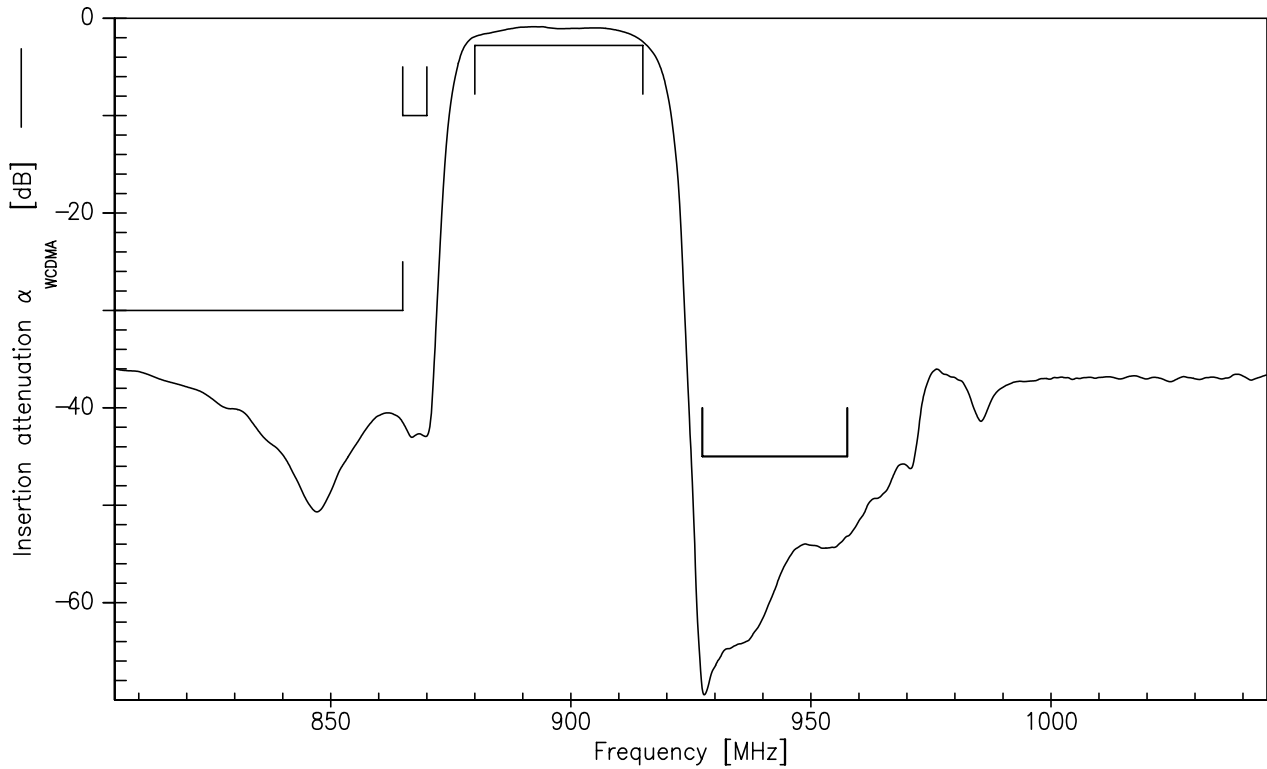

Frequency Response TX-ANT (wideband)

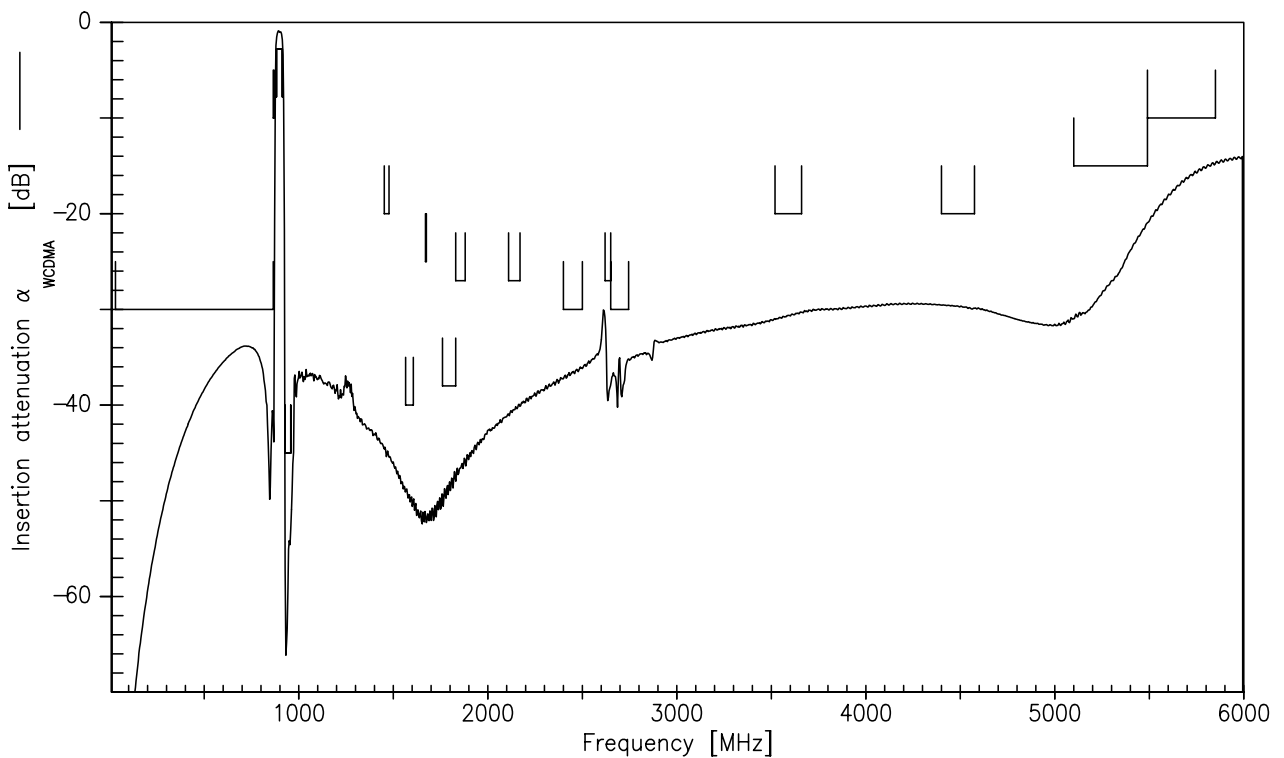

Data sheet



Frequency Response RX-ANT

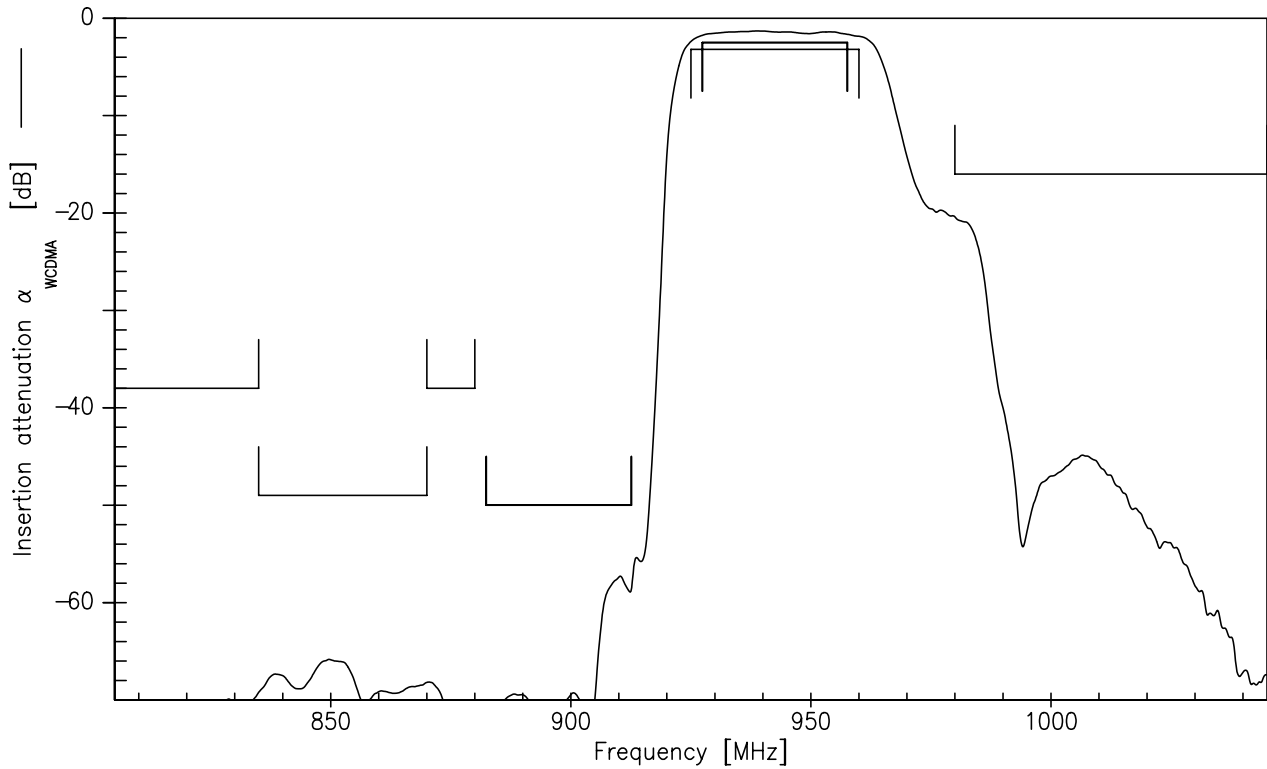

Frequency Response RX-ANT (wideband)

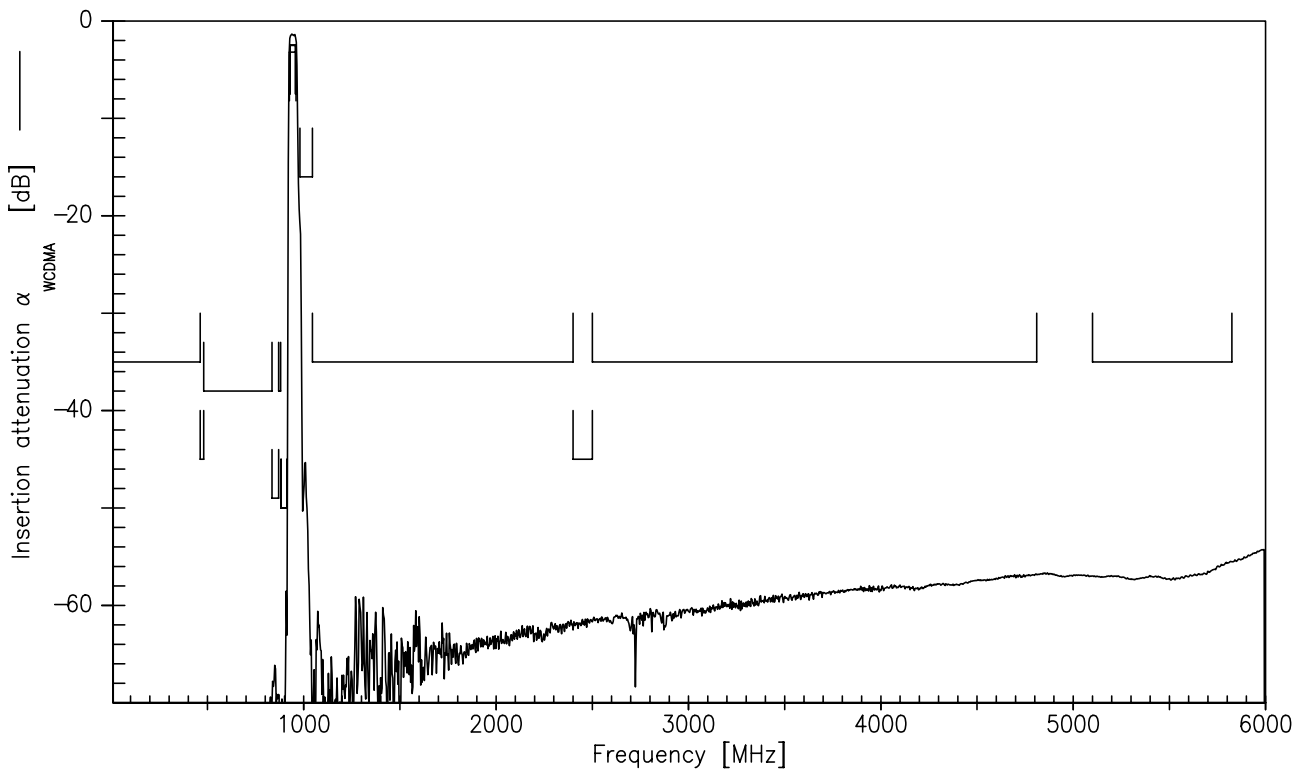

Data sheet



Frequency Response TX-RX

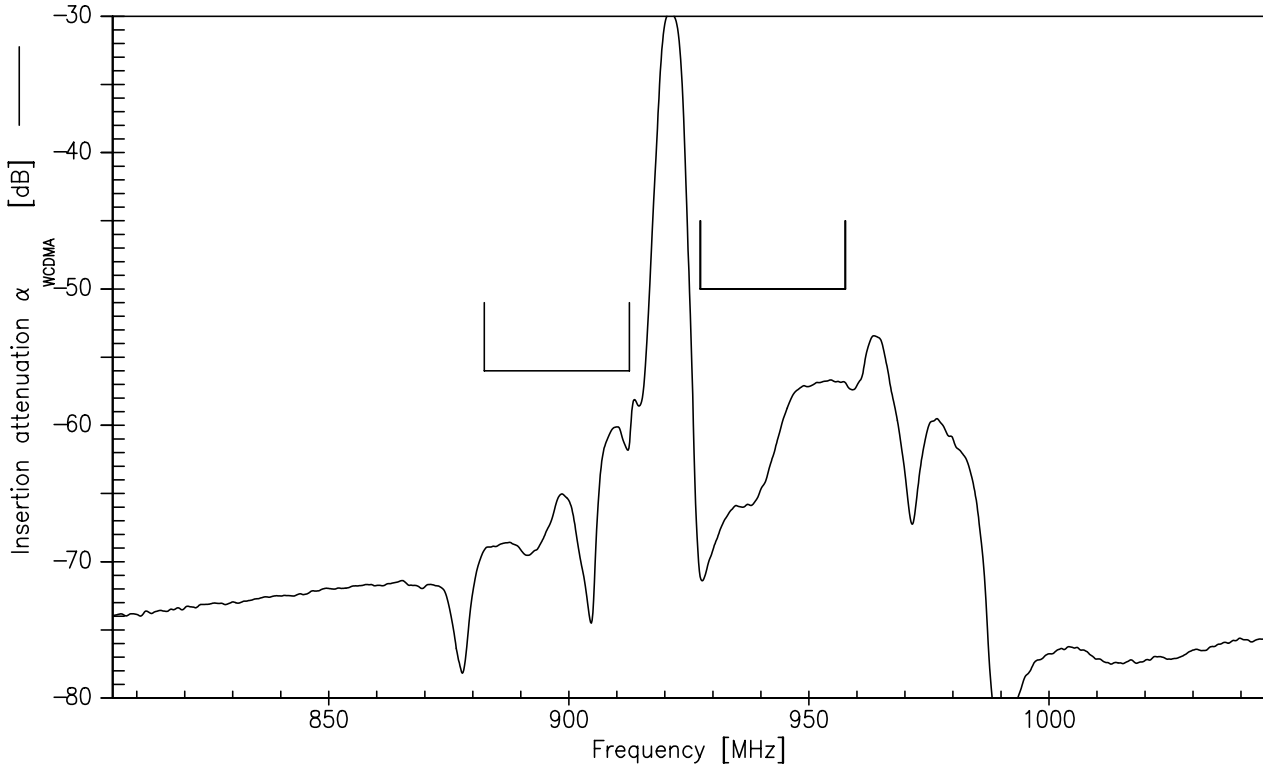

Frequency Response TX-RX (Common Mode)

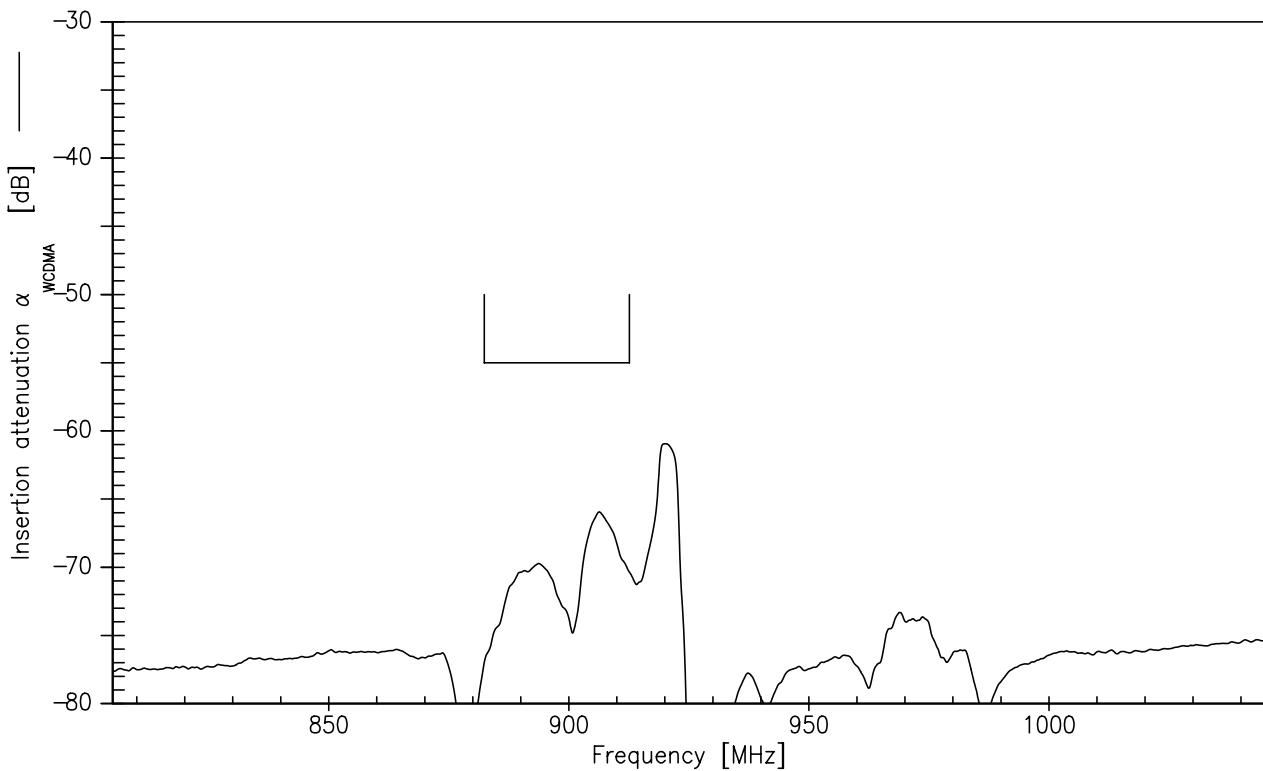

SAW Components

B4401

SAW Duplexer

897.5 / 942.5 MHz

Data sheet



Return Loss S_{11} TX-port S_{33} RX-port S_{22} ANT-port

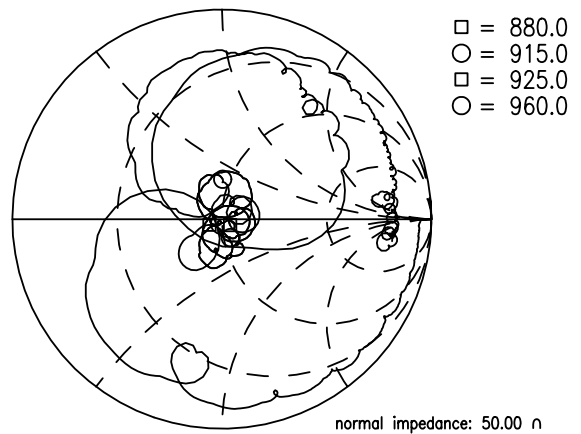
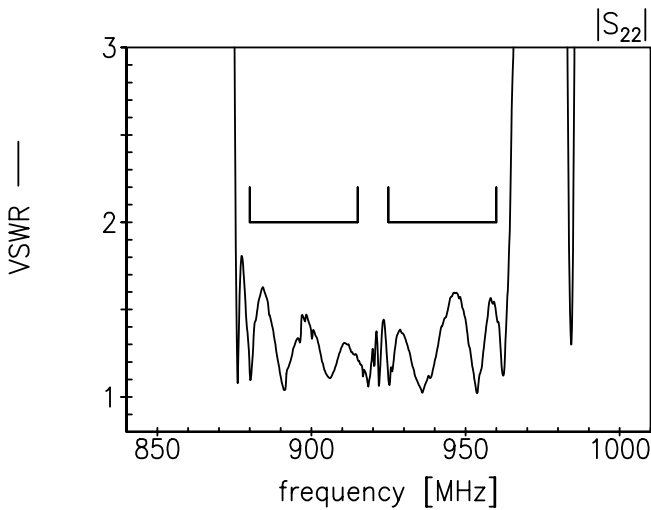
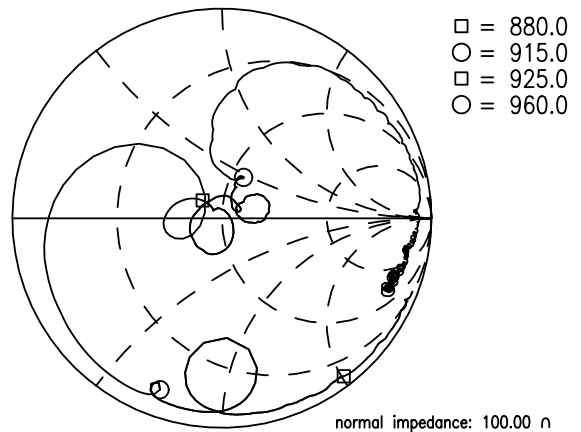
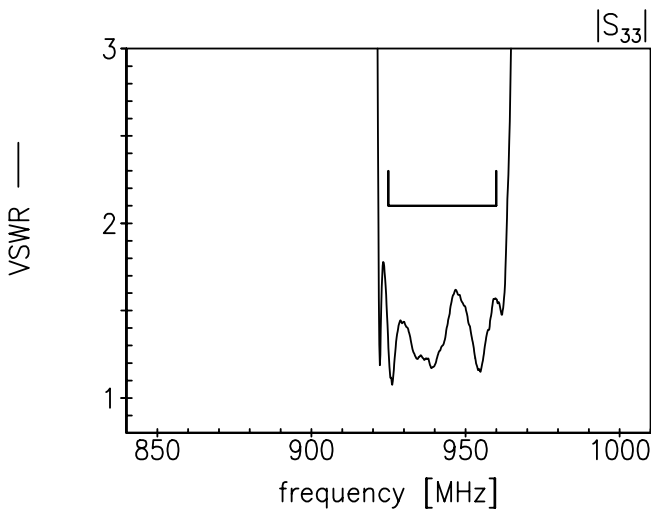
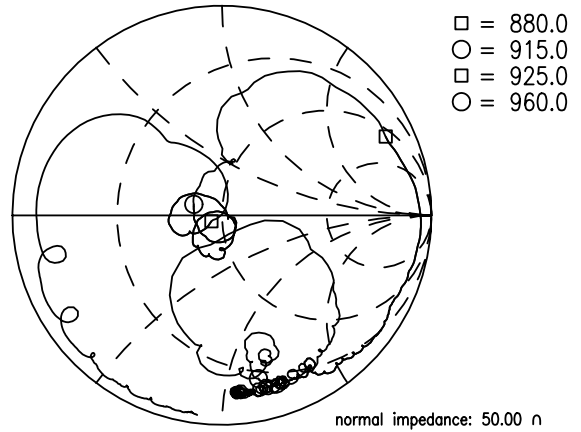
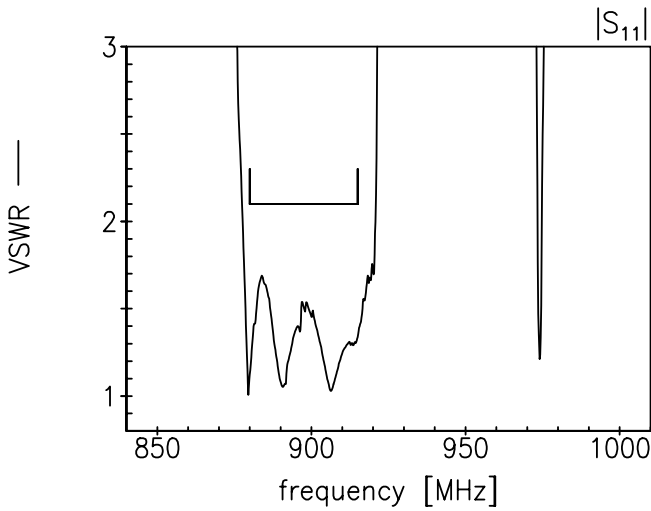

SAW Components
B4401
SAW Duplexer
897.5 / 942.5 MHz

Data sheet



References

Type	B4401
Ordering code	B39941B4401P810
Marking and package	C61157-A8-A37
Packaging	F61074-V8247-Z000
Date codes	L_1126
S-parameters	B4401_NB_UN.s4p, B4401_WB_UN.s4p see file header for port/pin assignment table
Soldering profile	S_6001
RoHS compatible	RoHS-compatible means that products are compatible with the requirements according to Art. 4 (substance restrictions) of Directive 2011/65/EU of the European Parliament and of the Council of June 8 th , 2011, on the restriction of the use of certain hazardous substances in electrical and electronic equipment ("Directive") with due regard to the application of exemptions as per Annex III of the Directive in certain cases.
Moldability	Before using in overmolding environment, please contact your EPCOS sales office.
Matching coils	See Inductor pdf-catalog http://www.tdk.co.jp/tefe02/coil.htm#aname1 and Data Library for circuit simulation http://www.tdk.co.jp/etvcl/index.htm

For further information please contact your local EPCOS sales office or visit our webpage at www.epcos.com.

Published by EPCOS AG
Systems, Acoustics, Waves Business Group
P.O. Box 80 17 09, 81617 Munich, GERMANY

© EPCOS AG 2013. This brochure replaces the previous edition.

For questions on technology, prices and delivery please contact the Sales Offices of EPCOS AG or the international Representatives.

Due to technical requirements components may contain dangerous substances. For information on the type in question please also contact one of our Sales Offices.

Important notes

The following applies to all products named in this publication:

1. Some parts of this publication contain **statements about the suitability of our products for certain areas of application**. These statements are based on our knowledge of typical requirements that are often placed on our products in the areas of application concerned. We nevertheless expressly point out **that such statements cannot be regarded as binding statements about the suitability of our products for a particular customer application**. As a rule, EPCOS is either unfamiliar with individual customer applications or less familiar with them than the customers themselves. For these reasons, it is always ultimately incumbent on the customer to check and decide whether an EPCOS product with the properties described in the product specification is suitable for use in a particular customer application.
2. We also point out that **in individual cases, a malfunction of electronic components or failure before the end of their usual service life cannot be completely ruled out in the current state of the art, even if they are operated as specified**. In customer applications requiring a very high level of operational safety and especially in customer applications in which the malfunction or failure of an electronic component could endanger human life or health (e.g. in accident prevention or life-saving systems), it must therefore be ensured by means of suitable design of the customer application or other action taken by the customer (e.g. installation of protective circuitry or redundancy) that no injury or damage is sustained by third parties in the event of malfunction or failure of an electronic component.
3. **The warnings, cautions and product-specific notes must be observed.**
4. In order to satisfy certain technical requirements, **some of the products described in this publication may contain substances subject to restrictions in certain jurisdictions (e.g. because they are classed as hazardous)**. Useful information on this will be found in our Material Data Sheets on the Internet (www.epcos.com/material). Should you have any more detailed questions, please contact our sales offices.
5. We constantly strive to improve our products. Consequently, **the products described in this publication may change from time to time**. The same is true of the corresponding product specifications. Please check therefore to what extent product descriptions and specifications contained in this publication are still applicable before or when you place an order. We also **reserve the right to discontinue production and delivery of products**. Consequently, we cannot guarantee that all products named in this publication will always be available. The aforementioned does not apply in the case of individual agreements deviating from the foregoing for customer-specific products.
6. Unless otherwise agreed in individual contracts, **all orders are subject to the current version of the “General Terms of Delivery for Products and Services in the Electrical Industry” published by the German Electrical and Electronics Industry Association (ZVEI)**.
7. The trade names EPCOS, BAOKE, Alu-X, CeraDiode, CeraLink, CeraPlas, CSMP, CSSP, CTVS, DeltaCap, DigiSiMic, DSSP, FilterCap, FormFit, MiniBlue, MiniCell, MKD, MKK, MLSC, MotorCap, PCC, PhaseCap, PhaseCube, PhaseMod, PhiCap, SIFERRIT, SIFI, SIKOREL, SilverCap, SIMDAD, SiMic, SIMID, SineFormer, SIOV, SIP5D, SIP5K, TFAP, ThermoFuse, WindCap are **trademarks registered or pending** in Europe and in other countries. Further information will be found on the Internet at www.epcos.com/trademarks.