

MMBX / MCX series

R223 / R113 / R213

Pages

MMBX

Introduction 4-4 to 4-6

Interface 4-7

Characteristics 4-8

Plugs 4-9

Receptacles 4-9 to 4-10

Adapters 4-11

Demo board 4-12

Panel drilling 4-12

Receptacle packaging 4-12

Assembly instructions 4-13

MCX

Introduction 4-4 to 4-5 and 4-14

Interface 4-14

Characteristics 4-15 to 4-16

Plugs 4-17 to 4-18

Jacks 4-18

Receptacles 4-19 to 4-20

In series adapters 4-20

Panel drilling 4-21

Packaging 4-21

Assembly instructions 4-22

INTRODUCTION

BOARD TO BOARD SOLUTIONS



The Best Systems

Radiall's engineers work with your engineers allowing us to develop the best competitively priced misalignment RF coaxial interconnect solutions on the market today.

The Best Choices

Radiall offers more board 2 board choices with four different product groups and ten connector series that can address the most demanding wireless telecom applications required for the new generation of infrastructure compact equipment. From base stations to repeaters and even handheld and GPS devices, we have a tailored connector solution for you; including the new SMP-MAX, SMP-Spring, IMP-Spring and other large, limited and no misalignment solutions.



*SMP-MAX
Receptacle*

SMP-MAX

Get the best for less with the new SMP-MAX large misalignment solution. Its patented impedance matching insulator is optimized for a larger operating gap between connectors making it easier for engineers to handle a board 2 board distance tolerance of at least .078" (2.0 mm) without a spring, which is 300% more than the standard SMP! It features a 3° minimum tilt (radial travel) and it has an operating frequency range of DC-6 GHz and a 1.2 max VSWR guaranteed at DC-3 GHz.

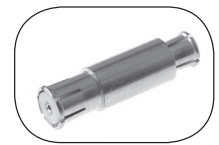

SMP-MAX Adapter

Spring-loaded Connectors

Radiall's one connector IMP-Spring and three connector SMP-Spring and MMBX-Spring large misalignment spring-loaded series are the best for increased maximum distance tolerances.

IMP-Spring is a cost effective unique one connector solution that offers up to .023" (.6 mm) board 2 board distance tolerance with a tilt (radial travel) up to 4.5°.

The new SMP-Spring and MMBX-Spring offer up to .078" (2 mm) board 2 board distance tolerance and a 4.5° tilt (radial travel).

All spring-loaded solutions feature consistent VSWR and low RF leakage.



IMP-Spring and SMP-Spring

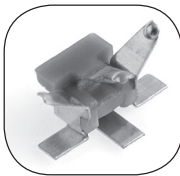

IMP

Limited Misalignment

Radiall's one connector IMP and three connector SMP and MMBX limited misalignment series are designed for applications requiring relatively precise distance tolerance of up to .023" (.6 mm) with a tilt (radial travel) of up to 4.5°.

No Misalignment

Radiall's MMT, MMS and MCX series are designed for applications requiring little or no distance tolerance between boards.

Family	Series	Misalignment tolerances		Dimensions		Performance		
		Angle tolerance (example with a 10mm distance between boards)	Board to board distance tolerance	Board to board minimum distance	PCB surface / size	Maximum frequency	Typical VSWR (min/max) at 3 GHz	Power at 3 GHz at 25°C
No misalignment	MMT	0	0	6.4 mm	4.2 X 4.9 / 25 mm ²	8 GHz	1,5	80W
	MMS	0	0	7.65 mm	4.2 X 5.1 / 21 mm ²	6 GHz	1,5	80W
	MCX	0	0	7.95 mm	6 X 6 / 36 mm ²	6 GHz	1,25	120W
Limited misalignment	IMP	0	0.4 mm	2 mm	4.5 X 4.5 / 20 mm ²	6 GHz	1,25	50 W
	SMP	3.5°/0.3mm Max	0.5 mm	9.5 mm	5 X 5 / 25 mm ²	12.4 GHz	1,12	120 W
	MMBX	4.5°/0.7mm Max	0.6 mm	6.7 mm	4 X 4 / 16 mm ²	6 GHz	1,15	150 W
Large misalignment Spring loaded	IMP-Spring	Not specified	1.2 mm	8.1 mm	∅ 7 / 38 mm ²	18 GHz	1,2	150 W
	IMP-Spring	1° / 1 mm Max	2.0 mm	16 mm	∅ 7 / 38 mm ²	6 GHz	1,15	150 W
	SMP-Spring	3.5°/0.3mm Max	1.2 mm	15.6 mm	5 X 5 / 25 mm ²	12.4 GHz	1,15	150 W
	MMBX-Spring	4.5°/0.7mm Max	1.6 mm	18 mm	6 X 6 / 36 mm ²	6 GHz	1,18	150 W
Large misalignment cost effective	SMP-Max	3°/1mm Min	2.0 mm Min	13 mm	5.6 X 5.6 / 31 mm ²	6 GHz	1,2	300 W at 2.7 GHz

INTRODUCTION



50Ω

DC - 12.4 GHz

GENERAL

- Snap-on mating
- Microminiature coaxial connectors
- Robust
- Surface mount receptacles
- Fully compatible with automated pick and place machines

APPLICATIONS

- Board to board applications
- Base station
- High density packaging

The MMBX™ connector series is particularly suitable for board to board connection in new generation telecommunication systems. MMBX™ connectors allow a quick connection in a minimum space requirement. Frequency range is DC to 12.4 GHz. SMT connectors are totally compatible with pick and place machines.

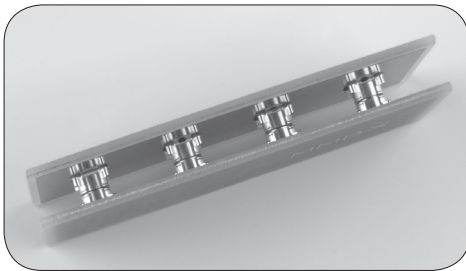

• Space saving

Its small space requirement is a main advantage for applications such as board to board connections as the height is only 7 mm.

• Series Range

Receptacles and in-series adapters can be either sold separately or with the in-series adapter already inserted in the receptacle. In this case, assembly time will be reduced and you will be sure that the in-series adapter is properly inserted, as it has to be assembled perpendicularly to the receptacle.

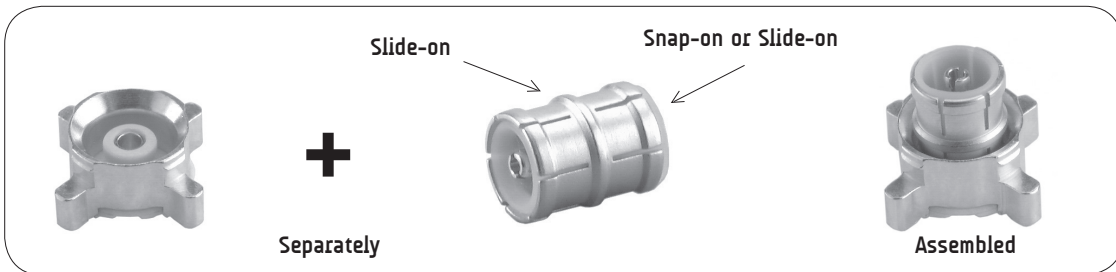

Retention between receptacle and in-series adapter is ensured by the design of the adapter.

- Slide-on/Snap-on: for board to board application, all in-series adapters remain on the same side during disconnection.
- Slide-on/Slide-on

In addition of PCB connectors and in-series adapters, Radiall offers you a wide range of products like straight plugs, right angle plugs and between-series adapters.

PCB connectors

PLUG

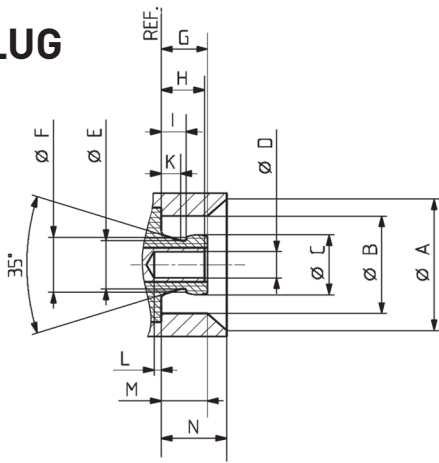

JACK

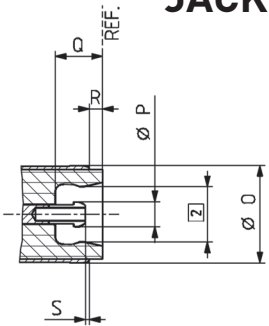

Letter	mm		inch	
	min.	max.	min.	max.
A	5.00 nom.	5.00 nom.	.197 nom.	.197 nom.
B	3.68	3.71	.145	.146
C	2.25	2.30	.088	.090
D	0.98	1.01	.038	.040
E	1.85 nom.	1.85 nom.	.073 nom.	.073 nom.
F	2.10 nom.	2.10 nom.	.083 nom.	.083 nom.
G		1.80		.071
H	1.55	1.75	.061	.069
I	0.90		.035	

Letter	mm		inch	
	min.	max.	min.	max.
K	0.75 nom.	0.75 nom.	.029 nom.	.029 nom.
L	0		0	
M	1.45		.057	
N	2.50 nom.	2.50 nom.	.098 nom.	.098 nom.
O	3.70 nom.	3.70 nom.	.146 nom.	.146 nom.
P	0.95 nom.	0.95 nom.	.037 nom.	.037 nom.
Q	1.85 nom.	1.85 nom.	.073 nom.	.073 nom.
R	0.50 nom.	0.50 nom.	.020 nom.	.020 nom.
S	0.10 nom.	0.10 nom.	.004 nom.	.004 nom.

In series adapters

Slide-on

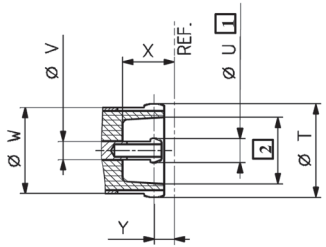

Snap-on

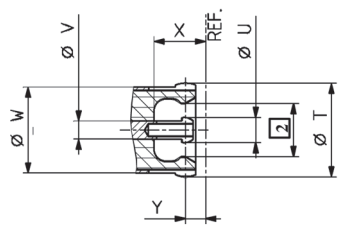

Letter	mm	inch
T	3.70 nom.	.146 nom.
U	0.95 nom.	.037 nom.
V	0.70 nom.	.027 nom.

Letter	mm	inch
W	3.65 nom.	.144 nom.
X	2.05 nom.	.080 nom.
Z	0.80 nom.	.031 nom.

1 Slotted and flared to meet electrical and mechanical requirements
 2 Dimension to meet electrical and mechanical requirements

CHARACTERISTICS

Test/characteristics	CECC 22000	Values/remarks
----------------------	------------	----------------

ELECTRICAL CHARACTERISTICS

Impedance		50Ω		
Frequency range		DC - 12.4 GHz		
Typical V.S.W.R. straight connectors: 2/50/S 2.6/50/S 2.6/50/D right angle connectors: 2/50/S 2.6/50/S 2.6/50/D		DC - 1 GHz	1 - 2.5 GHz	2.5 - 6 GHz
		1.05	1.06	1.10
		1.05	1.06	1.10
		1.05	1.06	1.10
		1.05	1.13	1.22
		1.05	1.06	1.17
		1.05	1.06	1.13
Insulation resistance		> 1 GΩ		
Dielectric withstanding voltage (sea level)	2.50	500 Vrms. 50 Hz		
	2.6/50	750 Vrms. 50 Hz		
Contact resistance	center contact	4.4.2	≤ 5 mΩ	
	outer contact	4.4.3	≤ 1 mΩ	

MECHANICAL CHARACTERISTICS

Mechanical endurance	4.7.1	100 matings
Engagement and separation force	4.5.4	30 N max
		8-30 N
Contact captivation	4.5.2	≥ 10 N
Cable retention force	2/50	58 N
	2.6/50	110 N
Vibration	4.6.3 - IEC 68-2-6 Fc	MIL-STD-202, Method 204 D, condition A

ENVIRONMENTAL CHARACTERISTICS

Temperature range		-55°C + 155°C
Thermal shock	4.6.7 - IEC 68-2-14 Na	MIL STD 202, method 107G, condition B1
Moisture resistance	4.6.6 - IEC 68-2-3 Ca	MIL STD 202, method 106F
Corrosion	4.6.10 - IEC 68-2-11 Ka	MIL STD 202, method 101, condition B
Vibration	4.6.3 - IEC 68-2-6 Fc	MIL STD 202, method 204D, condition A

MATERIALS

Center & outer contacts		Beryllium copper
Bodies		Brass
Ferrules		Copper
Insulators		PTFE

PLATING

Center & outer contacts		Gold/NPGR
Bodies		NPGR
Ferrules		NPGR

All dimensions are given in mm.

Standard packaging = 100 pieces.

STRAIGHT PLUGS (male center contact)

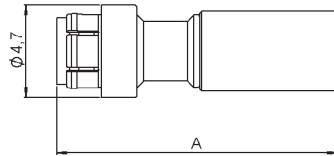
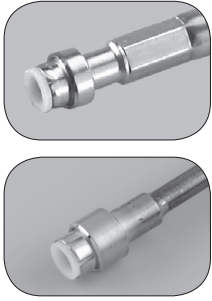

Fig. 1

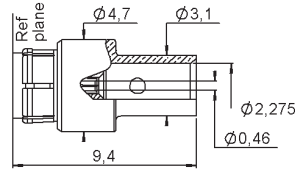

Fig. 2

Cable group	Cable group dia.	Part number	Fig.	A	Captive center contact	Note
RG178/RG196	2/50/S	R223 081 000	1	14.3	yes	Crimp type for flexible cables
RG174/RG316	2.6/50/S	R223 082 000	1	14.5		
RG316	2.6/50/D	R223 083 000	1			
RG405	.085"	R223 062 000	2			Solder type for semi-rigid cables

RIGHT ANGLE PLUGS (male center contact)

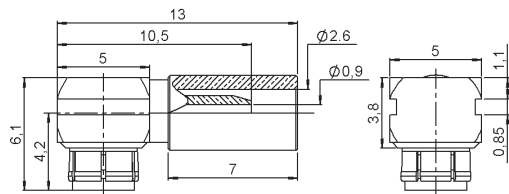
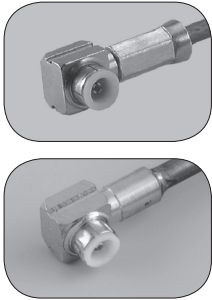

Fig. 1

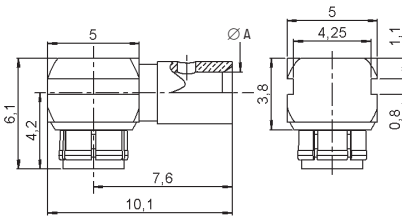

Fig. 2

Cable group	Cable group dia.	Part number	Fig.	A	Captive center contact	Note
RG178/RG196	2/50/S	R223 181 000	1		yes	Crimp type for flexible cables
RG174/RG316	2.6/50/S	R223 182 000	1			
RG316	2.6/50/D	R223 183 000	1			
RG405	.085"	R223 162 000	2	2.275		Solder type for semi-rigid cables

STRAIGHT PCB RECEPTACLES (male center contact)

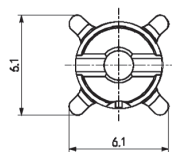
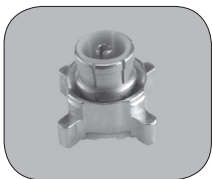

Fig. 1

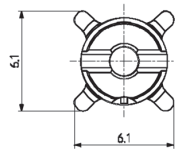
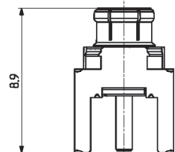
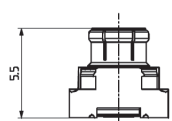

Fig. 2



Part number	Fig.	Captive center contact	PCB	Assembly instructions	Packaging	Note
R223 434 000	1	yes		M01	bulk 100 pieces	SMT
R223 434 800	1				tape & reel 720 pieces	
R223 435 000	2		P01		bulk 100 pieces	

To download data sheets and assembly instructions, visit www.radiall.com & enter the part number in the Search box. **Bold** part numbers represent products typically in stock & available for immediate shipment. See page 8 and 9 for packaging information.

PCB RECEPTACLES

EDGE CARD PCB RECEPTACLES (female center contact)

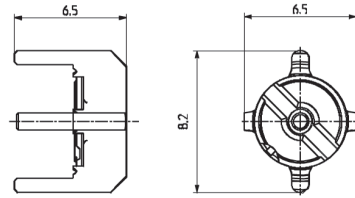
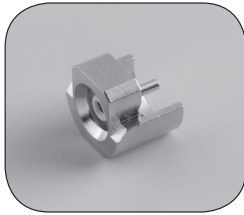

Fig. 1

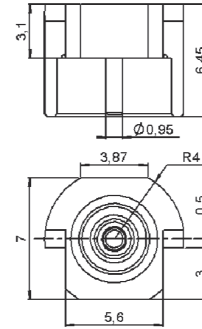

Fig. 2

Part number	Fig.	Captive center contact	Packaging	Note
R223 423 000	1	yes	bulk 100 pieces	SMT edge card
R223 423 010	2			

STRAIGHT PCB RECEPTACLES (female center contact)

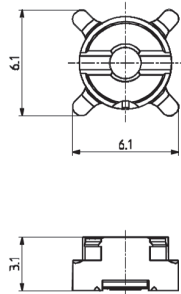
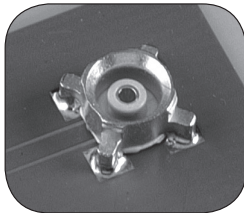

Fig. 1

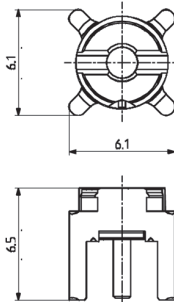

Fig. 2

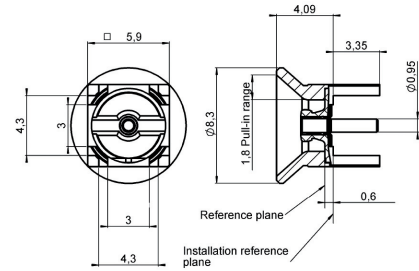
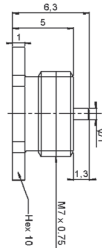
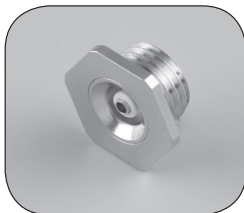

Fig. 3

Part number	Fig.	Captive center contact	PCB	Assembly instructions	Packaging	Note
R223 424 000	1	yes		M01	bulk 100 pieces	SMT
R223 424 800	1				tape & reel 720 pieces	
R223 425 000	2				P01	bulk 100 pieces
R223 425 110	3		P01		bulk 100 pieces	

SCREW-ON RECEPTACLE (female center contact)



Part number	Captive center contact	Panel drilling
R223 555 000	yes	P03

To download data sheets and assembly instructions, visit www.radiall.com & enter the part number in the Search box. **Bold** part numbers represent products typically in stock & available for immediate shipment. See page 8 and 9 for packaging information.

IN SERIES ADAPTERS (male-male center contact)

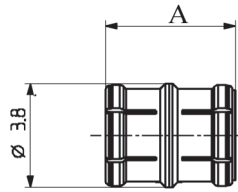
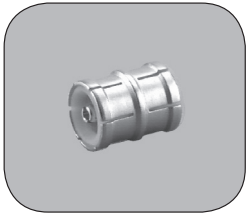

Part number	Length A (mm)	interface:	Nominal board to board
R223 703 000	4.8	snap-slide	6.7
R223 703 080	7.1	slide-slide	9

Other length can be designed upon request: minimum board to board height is 6.7 mm.

IN SERIES BULKHEAD ADAPTERS (male-male center contact)

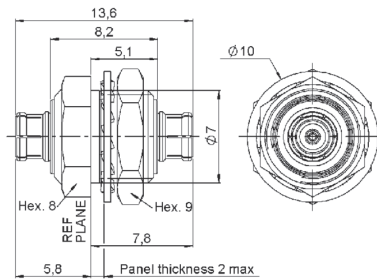

Part number	Series	Panel drilling
R223 720 020	MMBX male/MMBX male	P02

BETWEEN-SERIES ADAPTERS

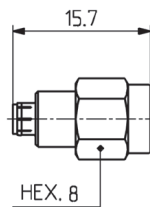

Fig. 1

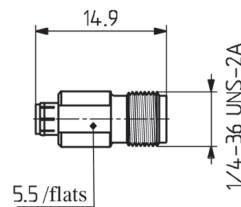

Fig. 2

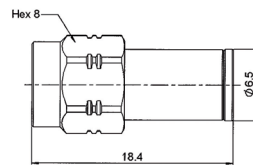

Fig. 3

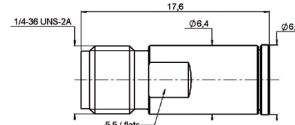
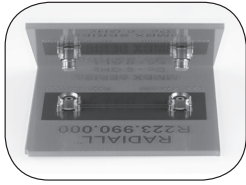

Fig. 4

Part number	Fig.	Series	Packaging
R191 389 100	1	MMBX male/SMA male	unit
R191 389 200	2	MMBX male/SMA female	
R191 389 300	3	MMBX female/SMA male	
R191 389 400	4	MMBX female/SMA female	

To download data sheets and assembly instructions, visit www.radiall.com & enter the part number in the Search box. **Bold** part numbers represent products typically in stock & available for immediate shipment. See page 8 and 9 for packaging information.

DEMO BOARDS



Part number	Note
R223 990 000	2 SMT receptacles
R223 991 000	2 SMT receptacles with adapters

PANEL DRILLING

P01

A DIA
5 holes

	mm		inch	
	maxi	mini	maxi	mini
A	1.4	1.2	.055	.047
B	5.16	5	.203	.197

P02

	mm		inch	
	maxi	mini	maxi	mini
A	7.27	7.13	.283	.281

P03

Threading	
ØA	M7 x 0.75

RECEPTACLE PACKAGING

The tape is delivered on reels of 330 mm diameter

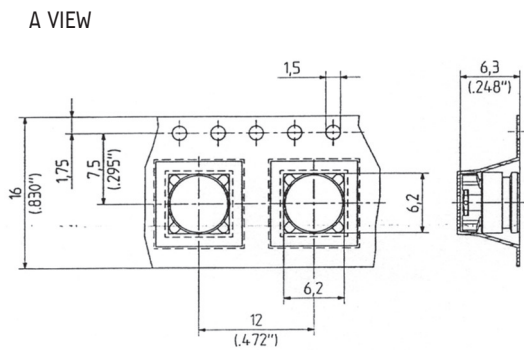
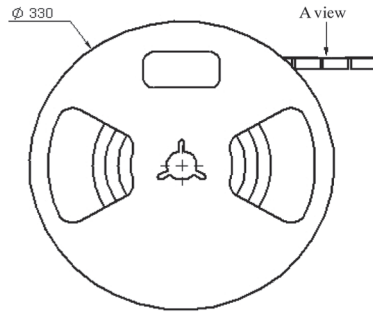

Part number	Note
R223 424 800	including 750 receptacles
R223 434 800	

M01

Part number			
R223 424 000	R223 424 800	R223 434 000	R223 434 800

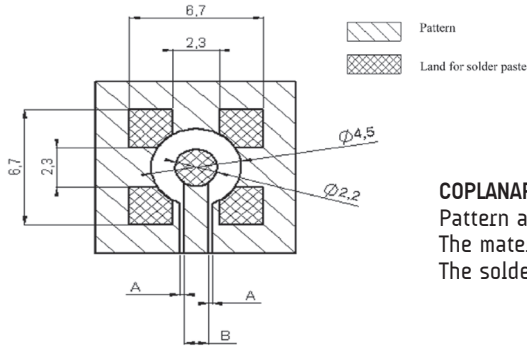

COPLANAR LINE

Pattern and signal are on the same side.

The material of PCB is epoxy resin (FR4) (Er = 4.6).

The solder resist should be printed except for the land pattern on the PCB.

APPLICATION 75Ω WITH B = 0.55 mm

PCB thickness (mm)	Coplanar line A (mm)
0.8	0.350
1.0	0.360
1.2	0.365
1.6	0.375

APPLICATION 50Ω WITH B = 1.2 mm

PCB thickness (mm)	Coplanar line A (mm)
0.8	0.190
1.0	0.200
1.2	0.205
1.6	0.210

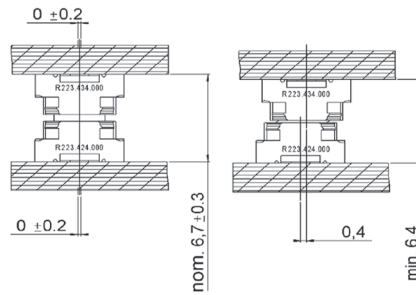
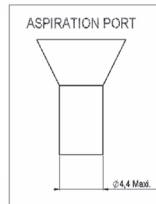
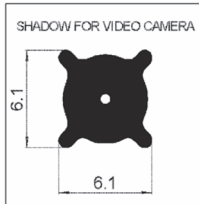

INTRODUCTION

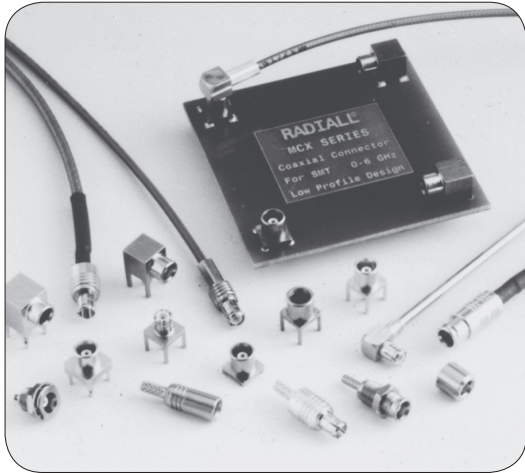

50Ω - 75Ω	DC - 6 GHz
-----------	------------

GENERAL

- Subminiature coaxial connectors
- "Push-pull" snap-on mating
- Complies with specification CECC 22220
- CEI standard 1169-36

APPLICATIONS

50Ω models

- Wireless communications
- Civil and military radio-telecommunication equipment

75Ω models

- Videocommunication
- Television broadcasting

The MCX series utilizes the SMB series electrical line and features a particularly simple, compact and robust interface.

The MCX series is 30 % smaller than the SMB.

The MCX series helps to **miniaturize equipment**. It lowers wiring connection costs through its full crimp and solder crimp versions as the centre contact of the straight models can be either crimped or soldered. It optimizes PCB layouts with its range of models for PCBs including surface mount and press-fit receptacles.

INTERFACE

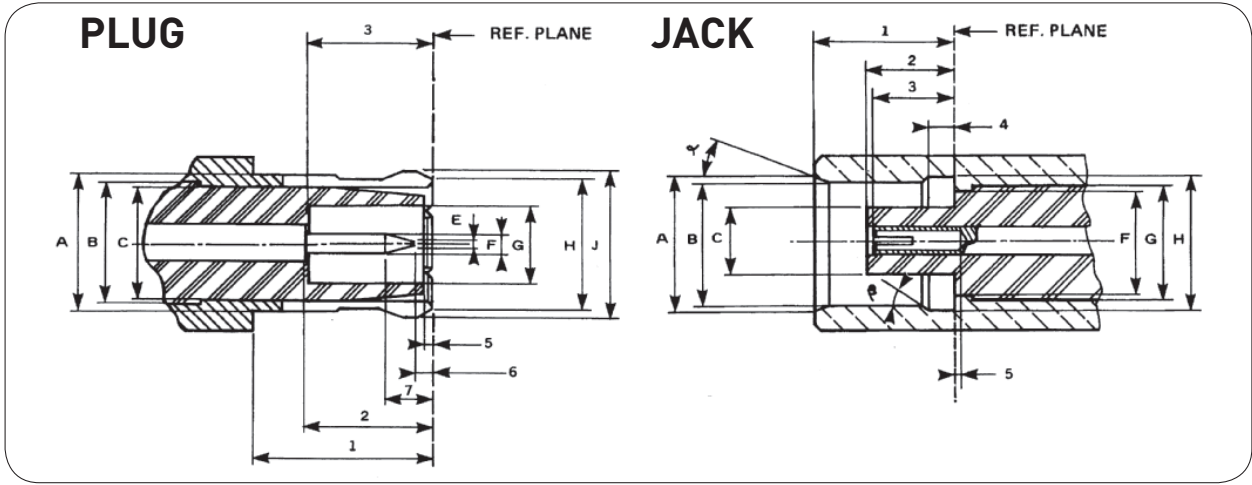

ITEM	mm		inch	
	min.	max.	min.	max.
1	4.15	-	.163	
2	2.80	3.20	.110	.126
3	2.80		.110	
5	0	0.30	0	.012
6	0.15		.006	
7		1.20		.047
A		3.40		.134
B	3.05 nom.		.120 nom.	
C		3.00		.118
E		0.25		.010
F	0.48	0.53	.019	.021
G	2.00		.079	
H		3.60		.142
J		3.80		.150

ITEM	mm		inch	
	min.	max.	min.	max.
1	4.00	4.12	.157	.162
2	2.60	2.80	.102	.110
3	2.30	2.80	.090	.110
4	0.75	0.85	.029	.033
5	0		0	
a	18°	22°	18°	22°
β	43°	47°	43°	47°
A	3.80		.150	
B	3.42	3.48	.135	.137
C		1.98		.078
F		3.00		.118
G	3.05 nom.		3.05 nom.	
H	3.60	3.75	.142	.148

Test/characteristics	Values/remarks
----------------------	----------------

ELECTRICAL CHARACTERISTICS

Impedance	50Ω and 75Ω		
Frequency range	DC - 6 GHz		
Typical V.S.W.R.	1 GHz	2.5 GHz	6 GHz
straight styles: .085	1.04	1.08	1.13
2.6/50/S	1.06	1.09	1.12
right angle styles: .085	1.03	1.06	1.10
2.6/50/S	1.04	1.07	1.10
Insulation resistance	1 000 MΩ		
Contact resistance (mΩ)	Initial	After environment	
center contact	≤ 5	≤ 15	
outer contact	≤ 2.5	≤ 7.5	
Voltage rating (V.R.M.R.)	At sea level	At 70.000 Ft	
• Cable RG 196/U - RG 188A/U - .047"	170 V rms max	45 V rms max	
• ∅ 2.6 double screen	335 V rms max	85 V rms max	
• RG 405/U - .085	250 V rms max	65 V rms max	
Dielectric withstanding voltage	At sea level	At 70.000 Ft	
• Cable RG 196/U - RG 188A/U - .047"	500 V rms max	100 V rms max	
• ∅ 2.6 double screen	750 V rms max	100 V rms max	
• RG 405/U - .085	750 V rms max	100 V rms max	
Power	P = 120W at 1.8 GHz, T = 40°C at sea level, VSWR = 1.1 for a straight plug MCX for ∅ 2.6/50/D cable		

MECHANICAL CHARACTERISTICS

Mechanical endurance	500 matings
Engagement	≤ 14.2 lbs - 63 N max
Separation force	≥ 1.8 Lbs - 8N ≤ 4.5 lbs 20 N
Cable retention force	RG 196A/U ≥ 7.2 lbs - 32 N RG 188A/U ≥ 11.9 lbs - 53 N ∅ 2.6/50 Ω double screen ≥ 24.1 lbs - 107 N .047" ≥ 9.7 lbs - 43 N RG 405/U-.085 ≥ 34.9 lbs - 155 N
Contact captivation	Axial force 2.25 Lbs 10 N

ENVIRONMENTAL CHARACTERISTICS

Operating temperature	-55°C +155°C	
Temperature cycling	CECC 22220 paragraph 4-6-5	
Thermal shock	CECC 22220 paragraph 4-6-7	MIL STD 202 - method 107 condition C
High temperature test	CECC 22220 paragraph 4-7-2	MIL STD 202 - method 108A condition D
Corrosion (salt spray)	CECC 22220 paragraph 4-6-10	MIL STD 202 - method 101 condition B
Vibration	CECC 22220 paragraph 4-6-3	MIL STD 202 - method 204 condition D

MATERIALS AND PLATING

	Materials	Platings
Bodies and male contacts	Brass	Gold/BBR (bodies)
Female center contacts	Beryllium copper	Gold
Ferrules	Brass	
Insulators	PTFE	

All dimensions are given in mm.

Standard packaging = 100 pieces.

CHARACTERISTICS

Test/characteristics	Values/remarks
----------------------	----------------

ELECTRICAL CHARACTERISTICS

Impedance	50Ω
Frequency range	DC - 6 GHz
Typical V.S.W.R. straight connectors	1.3
right angle connectors	1.35
Mating cycles	100
Temperature range	-40°C to +85°C

MATERIALS

Connector body	Brass
Insulator	PTFE
Female center contact	Bronze/Beryllium copper
Male center contact	Brass
Outer contact	Brass

PLATING AND PACKAGING

Body	Gold
Center contact	Gold
Outer contact	Gold
Female	Nickel
Packaging/MOQ	100 pieces bulk/MOQ 1000 pieces
	500 pieces reel/MOQ 1000 pieces
	unit packaging/MOQ 100 pieces

STRAIGHT PLUGS, FULL CRIMP TYPE, FOR FLEXIBLE CABLES

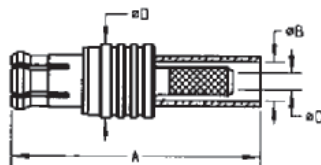
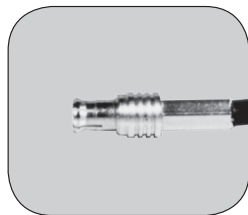

Cable group	Cable group dia.	Part number	Imp. (Ω)	Dimensions (mm)				Captive center contact	Finish
				A	B	C	D		
RG178/RG196	2/50/S	R113 081 000	50	16.1	2.55	1.1	5	no	Gold
RG174/RG316	2.6/50/S	R113 082 000		16.1	2.95	1.65			Gold
		R113A 082 000		18.7	-	1.55		Gold ECO version	
RD316	2.6/50/D	R113 083 000		16.2	3.25	1.65		Gold	
		R113A 083 000		18.7	-	1.55		Gold ECO version	
RG179	2.6/75/S	R213 082 007	75	18.2	2.95	1.7	5.8	yes	BBR
RD179	2.6/75/D	R213 083 007		18.3	3.25				

STRAIGHT PLUGS, SOLDER TYPE, FOR SEMI-RIGID CABLES

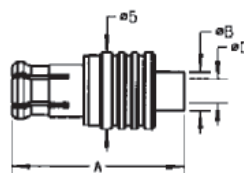
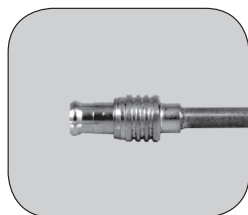

Cable group	Cable group dia.	Part number	Imp. (Ω)	Dimensions (mm)			Captive center contact	Finish
				A	B	C		
.047" semi-rigid	.047"	R113 051 000	50	11.3	2	1.3	no	Gold
RG405	.085"	R113 053 000			3	2.25		

RIGHT ANGLE PLUGS, CRIMP TYPE, FOR FLEXIBLE CABLES

(captive center contact)

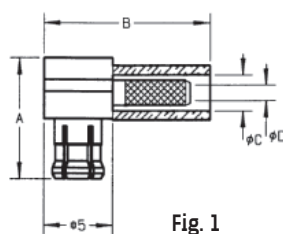
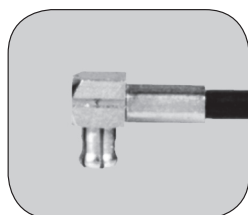

Fig. 1

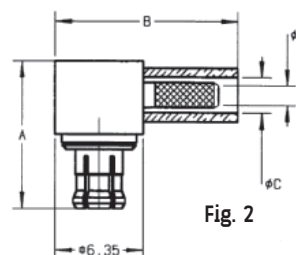

Fig. 2

Cable group	Cable group dia.	Part number	Fig.	Imp. (Ω)	Dimensions (mm)				Finish
					A	B	C	D	
RG178/RG196	2/50/S	R113 181 000	1	50	8.6	11.9	2.55	1.1	Gold
RG174/RG316	2.6/50/S	R113 182 000				11.9	2.95	1.65	Gold
		R113A 182 000			8.9	14.1	1.55	Gold ECO version	
RD316	2.6/50/D	R113 183 000			8.6	11.9	3.25	1.65	Gold
		R113A 183 000			8.9	14.1		1.55	Gold ECO version
RG179	2.6/75/S	R213 182 007	2	75	10.6	13.3	2.95	1.7	BBR
RD179	2.6/75/D	R213 183 007					3.25		

To download data sheets and assembly instructions, visit www.radiall.com & enter the part number in the Search box. **Bold** part numbers represent products typically in stock & available for immediate shipment. See page 8 and 9 for packaging information.

PLUGS AND JACKS

RIGHT ANGLE PLUGS, SOLDER TYPE (captive center contact)

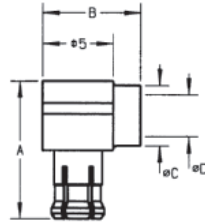
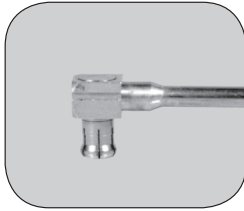

Cable group	Cable group dia.	Part number	Imp. (Ω)	Dimensions (mm)				Finish
				A	B	C	D	
.047" semi-rigid	.047"	R113 151 000	50	8.6	7	2.1	1.25	Gold
RG405	.085"	R113 153 000				3.1	2.25	
RG178/RG174/RG405	2/50/S - 2.6/50/S - .085"	R113 161 000		8	8	3.0	2.35	

STRAIGHT JACKS, FULL CRIMP TYPE, FOR FLEXIBLE CABLES

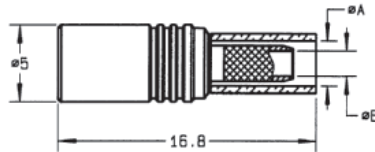

Fig. 1

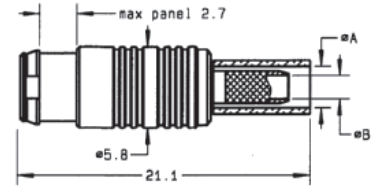
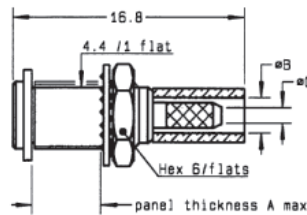
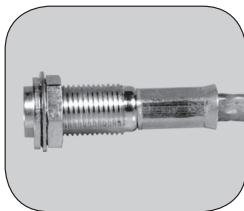

Fig. 2

Cable group	Cable group dia.	Part number	Fig.	Imp. (Ω)	Dimensions (mm)		Captive center contact	Panel drilling	Finish
					A	B			
RG178/RG196	2/50/S	R113 236 000	1	50	2.55	1.1	no		Gold
RG174/RG316	2.6/50/S	R113 240 000			2.95	1.65			
RG179	2.6/75/S	R213 238 007	2	75	2.95	1.7	yes	P01	BBR (Snap mount Panel thickness 2.5 ⁰ _{-0.1})

STRAIGHT BULKHEAD JACKS, FULL CRIMP TYPE, FOR FLEXIBLE CABLES



Cable group	Cable group dia.	Part number	Imp. (Ω)	Dimensions (mm)			Captive center contact	Panel drilling	Finish
				A	B	C			
RG178/RG196	2/50/S	R113 306 000	50	5	2.55	1.1	no	P02	Gold
RG174/RG316	2.6/50/S	R113 310 000			2.95	1.65	yes		

To download data sheets and assembly instructions, visit www.radiall.com & enter the part number in the Search box. **Bold** part numbers represent products typically in stock & available for immediate shipment. See page 8 and 9 for packaging information.

STRAIGHT FEMALE PANEL RECEPTACLES (captive center contact)

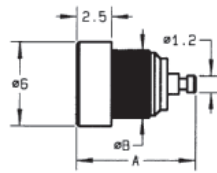
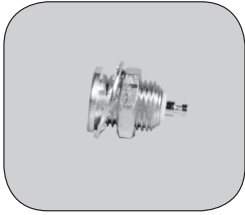

Fig. 1

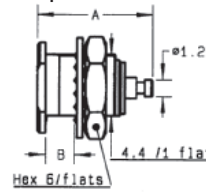
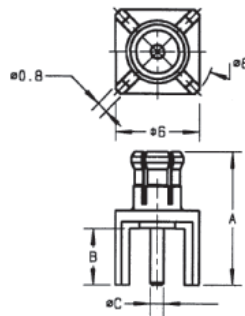
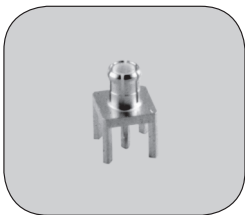

Fig. 2

Part number	Fig.	Imp. (Ω)	Dimensions (mm)		Panel drilling	Finish	Note
			A	B			
R113 402 220	1	50	8.7	4.8	P03	BBR	Press-in mount
R113 553 000	2		8.65	2.5	P02	Gold	Recessed front mount

STRAIGHT MALE PCB RECEPTACLES (captive center contact)



Part number	Imp. (Ω)	Dimensions (mm)			Panel drilling	Finish
		A	B	C		
R113 425 000	50	9.65	4.1	0.98	P05	Gold

STRAIGHT FEMALE PCB RECEPTACLES (captive center contact)

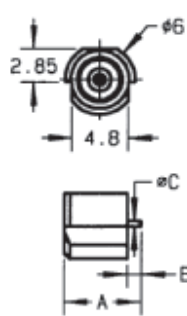

Fig. 1

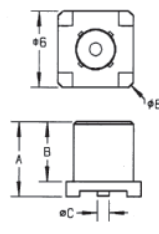

Fig. 2

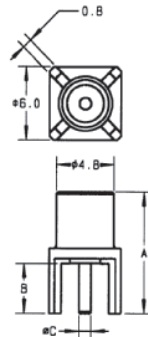

Fig. 3

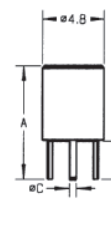

Fig. 4

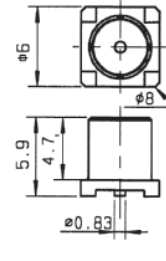

Fig. 5

Part number	Fig.	Imp. (Ω)	Dimensions (mm)			Assembly instructions	Panel drilling	Finish	Note	
			A	B	C					
R113 423 000	1	50	6.9	1.4	0.5	M01	Gold	SMT/Edge-card		
R113 424 000	2		5.9	4.7	0.96			SMT		
R113 424 010								SMT/reel 100 pieces		
R113 424 020								SMT/reel 500 pieces		
R113A 424 020								SMT/reel 500 pieces ECO version		
R113 426 000								100 pieces ECO version		
R113A 426 000	3		10	4.1	0.98			P05	BBR	
R113 426 020	4		9	3	0.5			P06	Gold	Space saving on PCB
R113 427 000								P05	Gold	
R213 426 000										
R213 424 800	5	75	10	4.1	0.71	M01	Gold	SMT/reel 100 pieces		

To download data sheets and assembly instructions, visit www.radiall.com & enter the part number in the Search box.
Bold part numbers represent products typically in stock & available for immediate shipment.
 See page 8 and 9 for packaging information.

RECEPTACLES AND IN SERIES ADAPTERS

RIGHT ANGLE FEMALE PCB RECEPTACLES (captive center contact)

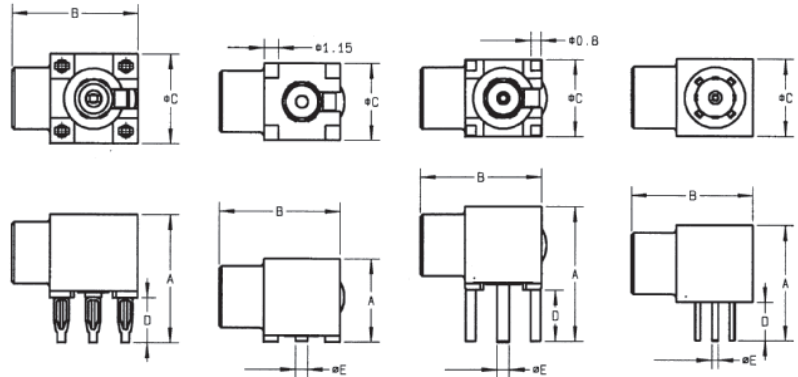
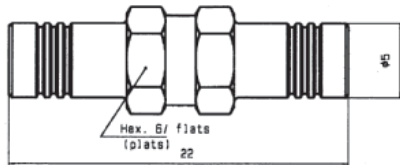

Fig. 1 Fig. 2 Fig. 3 Fig. 4

Part number	Fig.	Imp. (Ω)	Dimensions (mm)					Assembly instructions	Panel drilling	Finish	Note
			A	B	C	D	E				
R113 661 000	1	50	10	10	7	3.5			P04	Gold	Press-fit PCB mount
R113 664 000	2		6.5	9.5	6	4	0.96	M01			
R113A 664 120											
R113 665 000	3		10.5						P05	BBR	
R113 665 020											
R113 666 000	4			9	9.4		3	0.5		P06	Gold
R213 664 800	2	75	6.5	9.5	6		0.83	M01		SMT/reel 100 pieces	
R213 665 000	3		10.5					4	0.83		P05

IN SERIES ADAPTERS (female - female)



Part number	Imp. (Ω)	Finish
R113 704 000	50	Gold

To download data sheets and assembly instructions, visit www.radiall.com & enter the part number in the Search box. **Bold** part numbers represent products typically in stock & available for immediate shipment. See page 8 and 9 for packaging information.

PANEL DRILLING

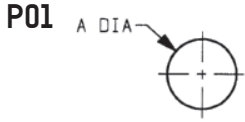

A	MM		INCH	
	maxi	mini	maxi	mini
5	4.97	0.197	0.196	

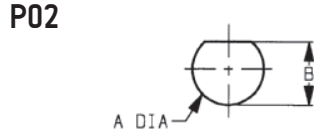

	MM		INCH	
	maxi	mini	maxi	mini
A	5	4.9	0.197	0.19
B	4.58	4.46	0.18	0.176

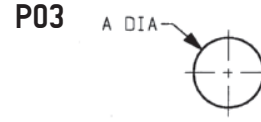

A	MM		INCH	
	maxi	mini	maxi	mini
4.77	4.74	0.188	0.187	

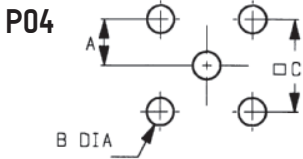

A	MM		INCH	
	maxi	mini	maxi	mini
2.565	2.515	0.101	0.1	
B	1.09	0.94	0.043	0.037
C	5.105	5.055	0.201	0.199

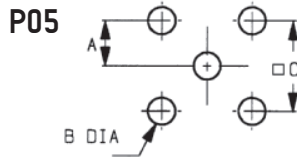

A	MM		INCH	
	maxi	mini	maxi	mini
2.56	2.52	0.101	0.099	
B	1.4	1.3	0.055	0.051
C	5.13	5.03	0.202	0.198

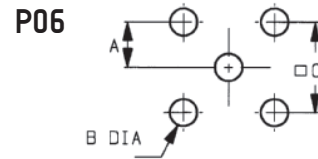

A	MM		INCH	
	maxi	mini	maxi	mini
1.30	1.24	.051	.049	
B	0.89	0.79	.035	.031
C	2.59	2.49	.102	.098



A	MM		INCH	
	maxi	mini	maxi	mini
1.4	1.3	0.055	0.051	
B	5.13	5.03	0.202	0.198

PACKAGING

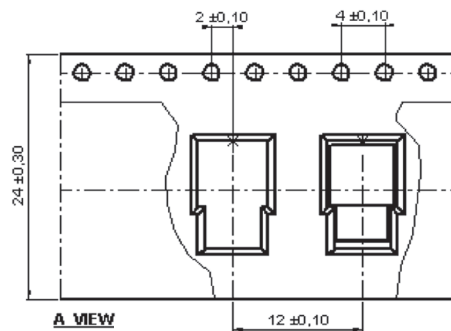
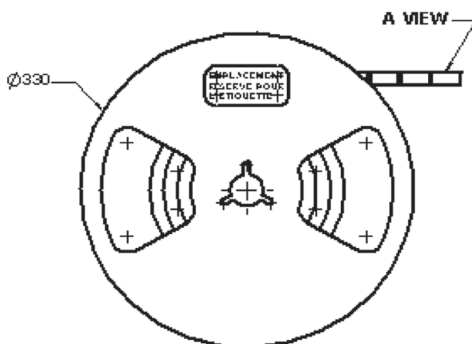

ASSEMBLY INSTRUCTIONS

M01

Part number
R113 423 000

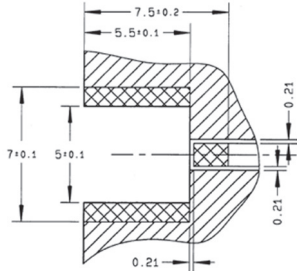

Part number	a	b	c
R113 424 000	Ø 1.7 ^{+0.1} ₀	1.2	0.21
R113A 424 020			
R113 424 010			
R113 424 020			
R113A 664 120	Ø 1.05	1.2	0.21
R213 424 800	Ø 1.57 ^{+0.1} ₀	1	0.63

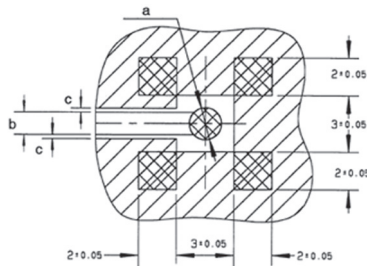

- Pattern
- Land for solder paste

COPLANAR LINE

Pattern and signal are on the same side.
 Thickness of PCB: .063 (1.6 mm).
 The material of PCB is the epoxy resin of glass fabrics bac (Er = 4.8).
 The solder resist should be printed

VIDEO SHADOW

Part number
R113 423 000

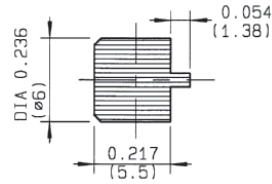

Part number	
R113 424 000	R113 424 020
R113 424 010	R113A 424 020
	R213 424 800

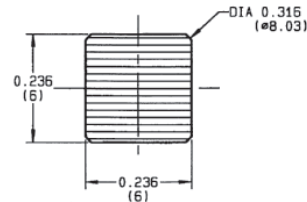

Part number	
R113 664 000	R213 664 800
	R113A 664 120

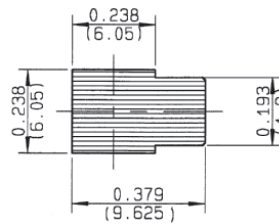

Vacuum nozzle dimensions

MCX 50Ω

MCX 75Ω

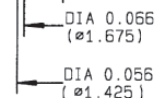
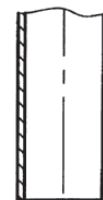
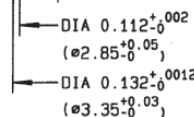
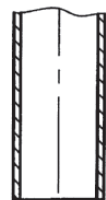



AEROSPACE



AUTOMOTIVE



DEFENSE



INDUSTRIAL



INSTRUMENTATION



MEDICAL



SPACE



TELECOM

EUROPE

France - RADIALL S.A.

101, Rue Ph. Hoffmann
93116 ROSNY sous BOIS (Paris)
Tel.: +33 1 49 35 35 35 - Fax: +33 1 48 54 63 63
E-Mail: info@radiall.com

Finland - RADIALL SF

P.O. Box 202 - 90101 OULU
Tel.: +358 407 522 412
E-Mail: infofi@radiall.com

Germany - RADIALL GmbH

Carl-Zeiss Str. 10 Postfach 200143
D63307 - RÖDERMARK (Frankfurt)
Tel.: +49 60 74 91 07 0 - Fax: +49 60 74 91 07 70
E-Mail: infode@radiall.com

Italy - RADIALL Elettronica S.R.L.

Via Concordia, 5 - 20090 ASSAGO MILANO
Tel.: +39 02 48 85 121 - Fax: +39 02 48 84 30 18
E-Mail: infoit@radiall.com
Regional office: Roma

Netherlands - RADIALL B.V.

Hogebrinkerweg 15b - 3871 KM HOEVELAKEN
Tel.: +31 33 253 40 09 - Fax: +31 33 253 45 12
E-Mail: infofl@radiall.com

Sweden - RADIALL A.B.

Sjöängsvägen 2 - SE-192 72 SOLLENTUNA (Stockholm)
Tel.: +46 844 434 10 - Fax: +46 875 449 16
E-Mail: infose@radiall.com

U.K. - RADIALL Ltd.

Ground Floor, 6 The Grand Union Office Park,
Packet Boat Lane
UXBRIDGE Middlesex UB8 2GH (London)
Tel.: +44 1895 425 000 - Fax: +44 1895 425 010
E-Mail: infouk@radiall.com

NORTH AMERICA

USA - RADIALL USA, Inc.

6825 West Galveston Street
CHANDLER, Arizona 85226
Tel.: +1 480 682 9400 - Fax: +1 480 682 9403
E-Mail: infousa@radiall.com

ASIA

China - SHANGHAI RADIALL Electronic Co., Ltd.

N° 390 Yong He Road 200072 - SHANGHAI
Tel.: +86 21 66 52 37 88 - Fax: +86 21 66 52 11 77
E-Mail: infozh@radiall.com

Japan - NIHON RADIALL

Shibuya-ku Ebisu 1-5-2, Kougetsu Bldg 405
TOKYO 150-0013
Tel.: +81 3 3440 6241 - Fax: +81 3 3440 6242
E-Mail: infojp@radiall.com

Hong Kong - RADIALL Electronics Ltd.

Flat D, 6/F, Ford Glory Plaza,
37-39 Wing Hong Street
Cheung Sha Wan
KOWLOON HONG KONG
Tel: +852-2959-3833 - Fax: +852-2959-2636
E-Mail: infohk@radiall.com

India - RADIALL India Pvt. Ltd.

25 D, II Phase, Peenya Industrial Area
BANGALORE 560058
Tel.: +91 80 83 95 271 - Fax: +91 80 83 97 228
E-Mail: infoin@radiall.com

ALSO REPRESENTED IN

Australia	Hungary	Poland
Austria	Indonesia	Russia
Belgium	Israel	Singapore
Brazil	Korea	Spain
Czech Republic	Latvia	Switzerland
Denmark	Lithuania	Taiwan
Estonia	Malaysia	Thailand
Greece	Norway	Vietnam
	Philippines	South Africa

For the above countries, please contact the local agent or RADIALL at info@radiall.com

