

CDSW4148-G

High Speed
RoHS Device

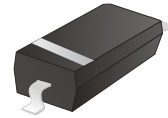

Features

- Fast Switching Speed
- Electrically Identical to Standard JEDEC
- High Conductance
- Surface Mount Package Ideally Suited for Automatic Insertion
- Flat Package SOD-123 in Stead mini-MELF Package
- High Speed

Mechanical data

- Case: SOD-123, Molded Plastic
- Terminals: Solderable per MIL-STD-202, Method 208
- Weight: 0.0097 gram(approx.).

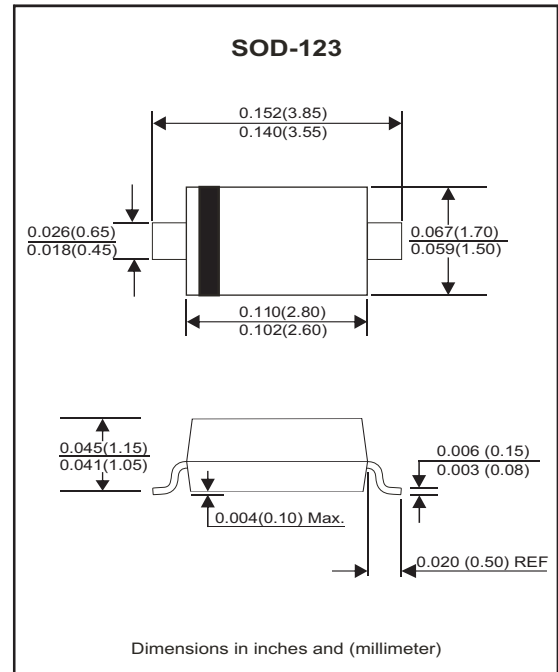

Maximum Rating (at Ta=25°C unless otherwise noted)

Parameter	Conditions	Symbol	Min	Max	Unit
Non-Repetitive peak reverse voltage		V_{RM}		100	V
Peak repetitive peak reverse voltage		V_{RRM}		100	V
Working peak reverse voltage		V_{RWM}		100	V
DC blocking voltage		V_R		100	V
RMS reverse voltage		$V_{R(RMS)}$		71	V
Forward continuous current		I_{FM}		300	mA
Average rectified output current		I_o		150	mA
Peak forward surge current	$T_P = 1\mu S$ $T_P = 1S$	I_{FSM}		2 1	A
Power dissipation		P_D		500	mW
Thermal Resistance (Junction to ambient)		$R_{\theta JA}$		250	°C/W
Storage temperature		T_{STG}	-55	+150	°C
Junction temperature		T_j	-55	+150	°C

Electrical Characteristics (at Ta=25°C unless otherwise noted)

Parameter	Conditions	Symbol	Min	Typ	Max	Unit
Forward voltage	$I_F = 1\text{ mA}$ $I_F = 10\text{ mA}$ $I_F = 50\text{ mA}$ $I_F = 150\text{ mA}$	V_F			0.715 0.855 1.0 1.25	V
Reverse current	$V_R = 20\text{ V}$ $V_R = 75\text{ V}$	I_R			25 1	nA μA
Capacitance between terminals	$f = 1\text{ MHz}$ and $V_R = 0V$	C_J			2	pF
Reverse recovery time	$I_F = I_R = 10\text{ mA}$, $R_L = 100\ \Omega$, $I_{rr} = 0.1 \times I_R$	T_{RR}			4	nS

Typical Characteristics (CDSW4148-G)

Fig.1 - Forward Characteristics

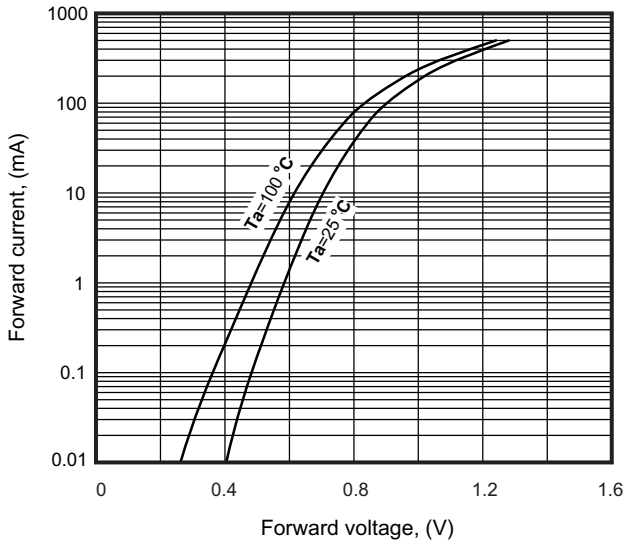

Fig.2 - Reverse Characteristics

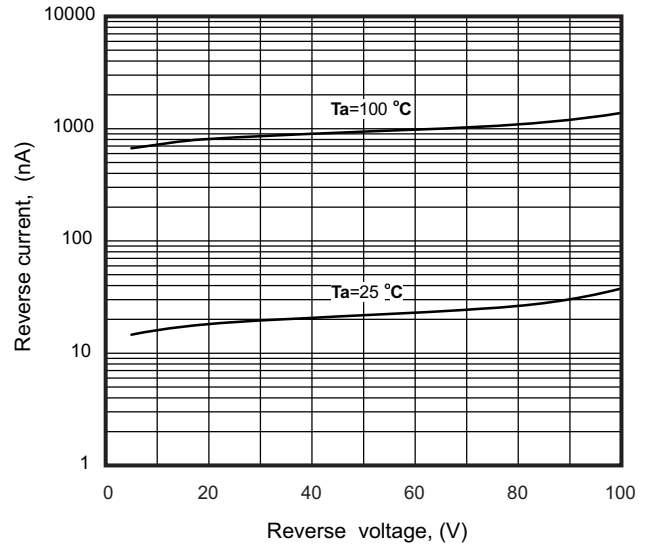

Fig.3 - Capacitance Characteristics

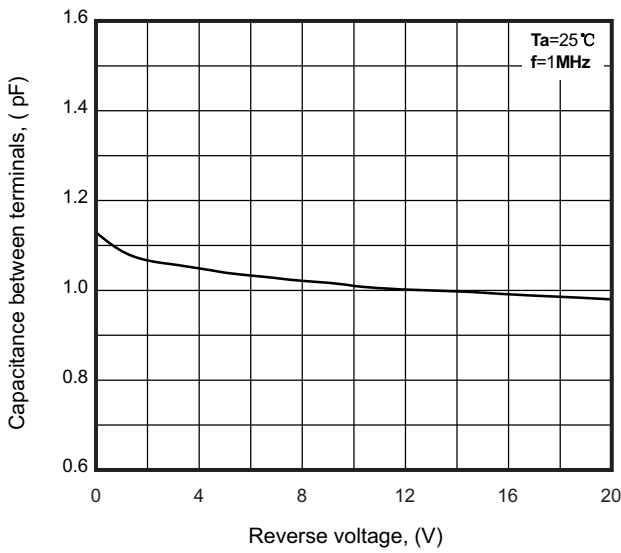
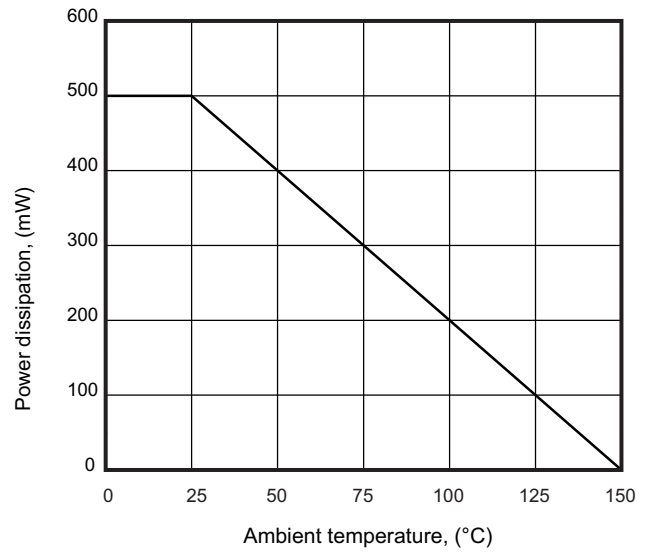
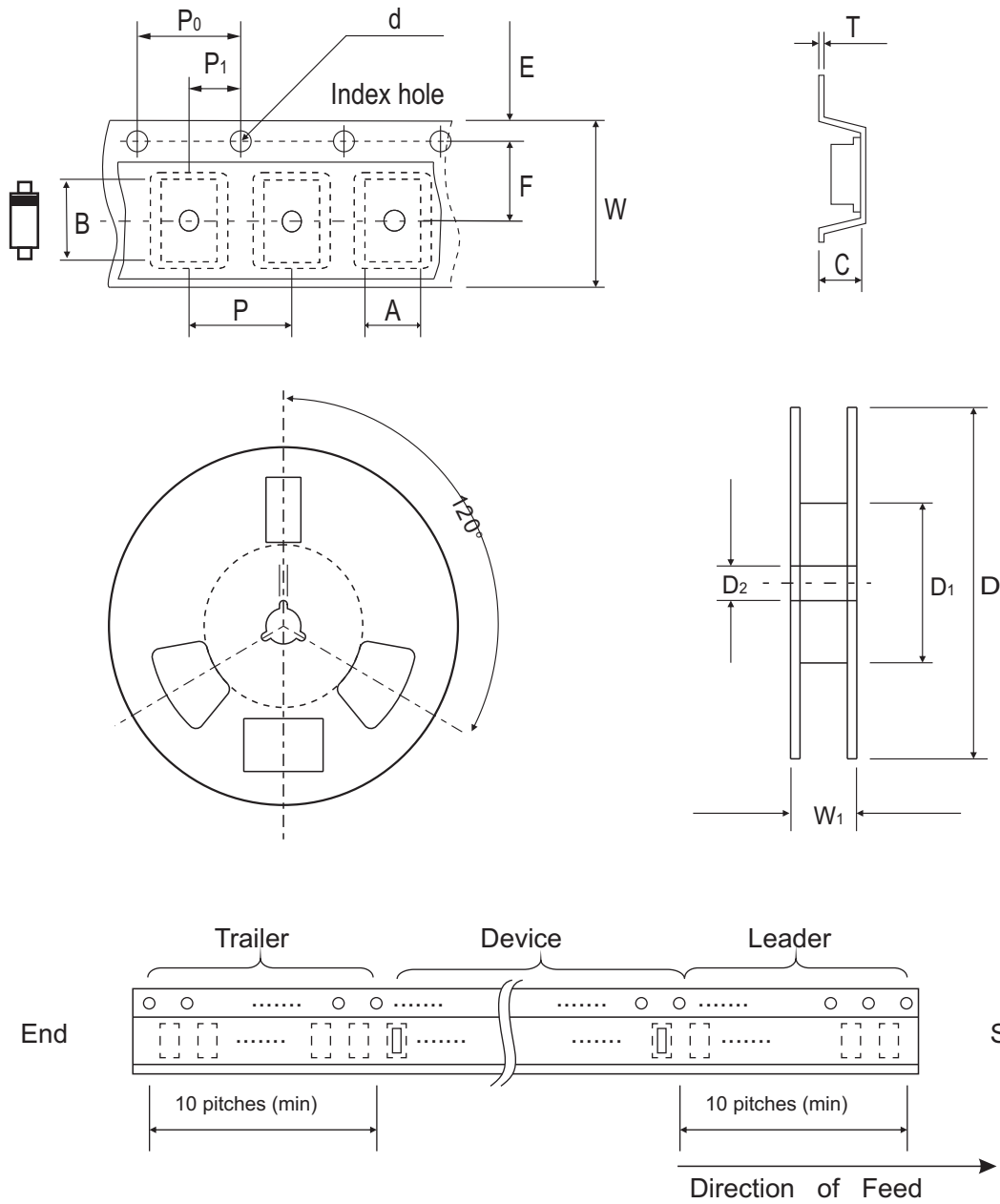

Fig.4 - Power Derating Curve



Reel Taping Specification



SOD-123	SYMBOL	A	B	C	d	D	D1	D2
	(mm)	1.85 ± 0.05	3.94 ± 0.05	1.57 ± 0.05	1.55 + 0.10	178 ± 2.00	54.40 ± 1.00	13.0 ± 1.00
	(inch)	0.073 ± 0.002	0.155 ± 0.002	0.062 ± 0.002	0.061 + 0.004	7.008 ± 0.079	2.142 ± 0.039	0.512 ± 0.039

SOD-123	SYMBOL	E	F	P	P0	P1	W	W1
	(mm)	1.75 ± 0.10	3.50 ± 0.05	4.00 ± 0.10	4.00 ± 0.10	2.00 ± 0.10	8.00 + 0.30/-0.10	12.30 ± 1.00
	(inch)	0.069 ± 0.004	0.138 ± 0.002	0.158 ± 0.004	0.158 ± 0.004	0.079 ± 0.004	0.315 + 0.012/-0.004	0.484 ± 0.039

Marking Code

Part Number	Marking Code
CDSW4148-G	T4



xx = Product type marking code

Suggested PAD Layout

SIZE	SOD-123	
	(mm)	(inch)
A	3.24	0.128
B	0.80	0.031
C	1.00	0.039
D	4.04	0.159
E	2.44	0.096

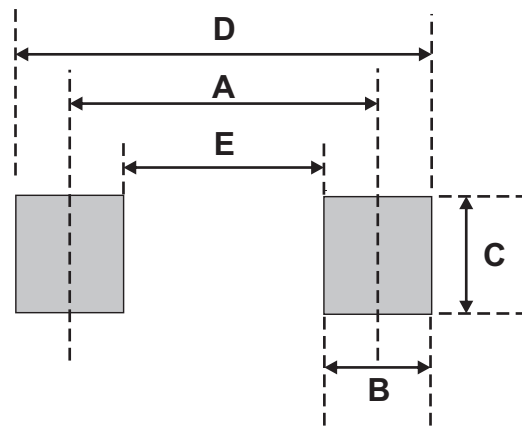

Standard Packaging

Case Type	REEL PACK	
	REEL (pcs)	Reel Size (inch)
SOD-123	3,000	7