

CMPWR330

400 mA SmartOR™ Regulator with V_{AUX} Switch

Product Description

The CMPWR330 is a dual input regulator with a fully integrated V_{AUX} switch capable of delivering up to 400 mA continuously at 3.3 V. The input is taken from three independent voltage sources on a prioritized basis. Power is always taken in priority using the order of V_{CC}, V_{SBY}, and V_{AUX}.

When V_{CC} (5 V) or V_{SBY} is present, the device automatically enables the regulator and produces a stable 3.3 V output at V_{OUT}.

When only V_{AUX} (3.3 V) is present, the device provides a low impedance direct connection (0.25 Ω TYP.) from V_{AUX} to V_{OUT}.

All the necessary control circuitry needed to provide a smooth and automatic transition between all three supplies has been incorporated. This allows the V_{CC} input supply to be dynamically switched without loss of output voltage.

The CMPWR330 is housed in an 8-pin SOIC package and is available with RoHS compliant lead-free finishing.

Features

- Continuous 3.3 V Output from Three Inputs
- Complete Power Management Solution
- V_{CC}, V_{SBY} Regulator Supplies 400 mA Output
- Built-In Hysteresis when Selecting Input Supplies
- Integrated Switch Has Very Low R_{DS(ON)} Resistance of 0.25 Ω (TYP)
- Foldback Current Limiting Protection
- Thermal Overload Shutdown Protection
- 8-Pin Power SOIC Package
- These Devices are Pb-Free and are RoHS Compliant

Applications

- PCI Adapter Cards with Wake-On-LAN
- Network Interface Cards (NICs)
- Multiple Power Systems
- Systems with Standby Capabilities



ON Semiconductor®

<http://onsemi.com>

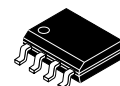

SOIC 8
SF SUFFIX
CASE 751BD

MARKING DIAGRAM

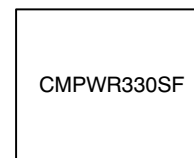

CMPWR330SF = Specific Device Code

ORDERING INFORMATION

Device	Package	Shipping†
CMPWR330SF	Power SOIC (Pb-Free)	750/Tape & Reel

†For information on tape and reel specifications, including part orientation and tape sizes, please refer to our Tape and Reel Packaging Specification Brochure, BRD8011/D.

CMPWR330

TYPICAL APPLICATION CIRCUIT

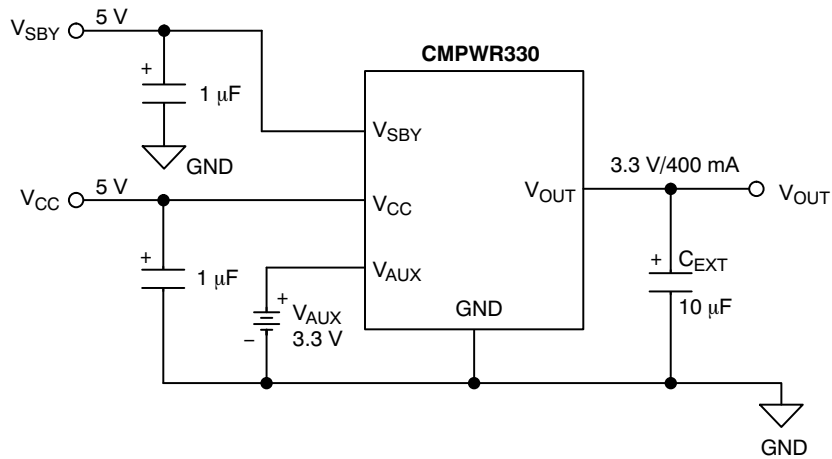

SIMPLIFIED ELECTRICAL SCHEMATIC

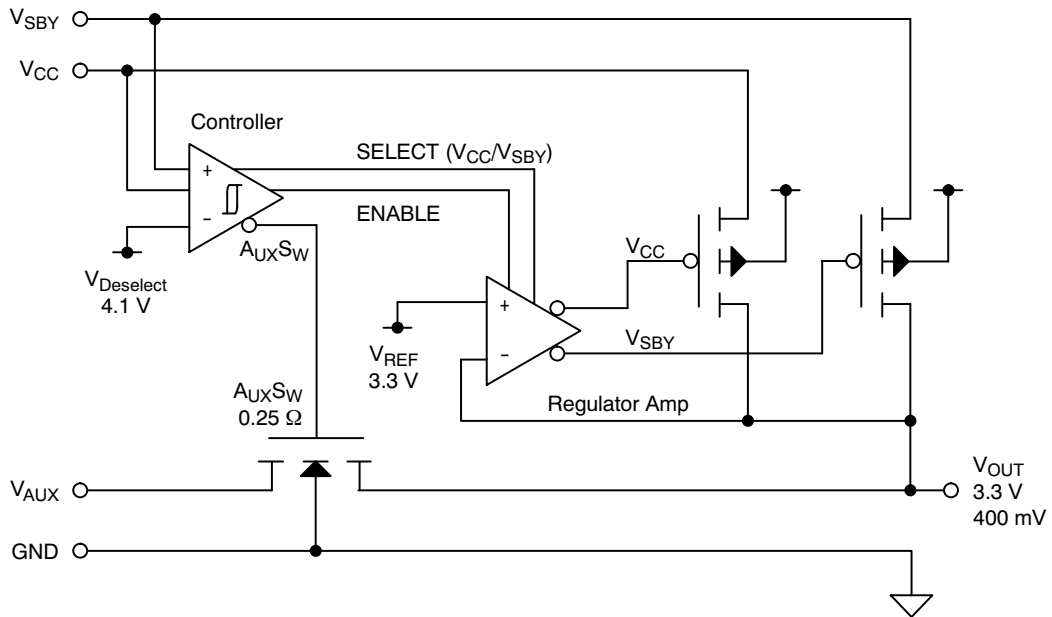

CMPWR330

PACKAGE / PINOUT DIAGRAM

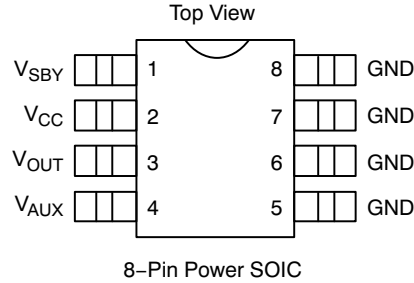

Table 1. PIN DESCRIPTIONS

Pin(s)	Name	Description
1	V _{SBY}	V _{SBY} is the standby input supply (5 V), which is used to power the regulator whenever V _{CC} is below the deselect level (4.2 V). If the V _{SBY} connection is made within a few inches of the main input filter, a bypass capacitor may not be necessary. Otherwise a bypass filter capacitor in the range of 1 μF to 10 μF will ensure adequate filtering.
2	V _{CC}	V _{CC} is a positive input supply for the voltage regulator. Whenever this supply voltage exceeds the V _{CCSEL} level (4.4 V), it will be given priority and be used to power the regulator output. If this supply voltage falls below the V _{CCDES} level (4.2 V) it will immediately be deselected and no longer provide power for the regulator output. An internal hysteresis voltage of 0.2 V is used to prevent any chatter during selection and deselection of V _{CC} . The effective source impedance of V _{CC} should be kept below 0.3 Ω to ensure changeover disturbances do not exceed the hysteresis level. If the connection to V _{CC} is made within a few inches of the main input filter, a bypass capacitor may not be necessary. Otherwise a bypass filter capacitor in the range of 1 μF to 10 μF will ensure adequate filtering.
3	V _{OUT}	V _{OUT} is the output voltage. Power is provided from the regulator or via the low impedance auxiliary switch. This output requires a capacitance of 10 μF to ensure regulator stability and minimize the peak output disturbance during power supply changeover.
4	V _{AUX}	V _{AUX} is the auxiliary voltage power source. This supply is selected only when V _{CC} falls below 4.2 V and the V _{SBY} is not present. Under these conditions an internal switch is enabled and provides a very low impedance connection directly between V _{AUX} and V _{OUT} .
5-8	GND	The negative reference for all voltages. Also functions as a thermal path for heat dissipation.

SPECIFICATIONS

Table 2. ABSOLUTE MAXIMUM RATINGS

Parameter	Rating	Units
ESD Protection (HBM)	±2000	V
Pin Input Voltages V _{CC} , V _{SBY} V _{AUX}	[GND - 0.5] to +6.0 [GND - 0.5] to +4.0	V
Storage Temperature Range	-40 to +150	°C
Operating Temperature Range Ambient Junction	0 to +70 0 to +125	°C
Power Dissipation (Note 1)	Internally Limited	W

Stresses exceeding Maximum Ratings may damage the device. Maximum Ratings are stress ratings only. Functional operation above the Recommended Operating Conditions is not implied. Extended exposure to stresses above the Recommended Operating Conditions may affect device reliability.

- At rated load, the power dissipation will be 0.68 W (1.7 V × 0.4 A). Under these conditions, (in a 70°C ambient), the thermal resistance from junction to ambient (θ_{JA}) must not exceed 80°C/W. This is typically achieved with 2 square inches of copper printed circuit board area connected to the GND pins for heat spreading, or equivalent.

CMPWR330

SPECIFICATIONS (Cont'd)

Table 3. STANDARD OPERATING CONDITIONS

Parameter	Rating	Units
V _{CC} , V _{SBY}	5.0 ±0.25	V
V _{AUX}	3.3 ±0.3	V
Ambient Operating Temperature Range	0 to +70	°C
Load Current	0 to 400	mA
C _{EXT}	10 ±20%	μF

Table 4. ELECTRICAL OPERATING CHARACTERISTICS (Note 1)

Symbol	Parameter	Conditions	Min	Typ	Max	Units
V _{OUT}	Regulator Output Voltage	0 mA < I _{LOAD} < 400 mA	3.135	3.300	3.465	V
I _{LIM}	Regulator Current Limit	V _{OUT} > 1 V		500		mA
I _{S/C}	Short Circuit Current	V _{CC} /S _{BY} = 5 V, V _{OUT} = 0 V		150		mA
V _{R LOAD}	Load Regulation	V _{CC} = 5 V, 5 mA ≤ I _{LOAD} ≤ 400 mA		20		mV
V _{R LINE}	Line Regulation	I _{LOAD} = 5 mA, 4.5 V ≤ V _{IN} ≤ 5.5 V		2		mV
V _{CCSEL}	V _{CC} Select Voltage	V _{SBY} or V _{AUX} Present		4.40	4.60	V
V _{CCDES}	V _{CC} Deselect Voltage	V _{SBY} or V _{AUX} Present	4.00	4.20		V
V _{HYST}	Hysteresis Voltage	V _{SBY} or V _{AUX} Present (Note 2)		0.20		V
R _{SW}	V _{AUX} Switch Resistance			0.25	0.40	Ω
I _{RCC} I _{RSBY} I _{RAUX}	V _{CC} Reverse Leakage V _{SBY} Reverse Leakage V _{AUX} Reverse Leakage	One supply input taken to GND while the others remain at nominal voltage.		5	100	μA
I _{CC}	V _{CC} Supply Current	V _{CC} > V _{CCSEL} , I _{LOAD} = 0 mA		0.8	1.5	mA
I _{SBY}	V _{SBY} Supply Current	V _{CC} < V _{CCSEL} , I _{LOAD} = 0 mA		0.8	1.5	mA
I _{AUX}	V _{AUX} Supply Current	V _{AUX} is Selected, I _{LOAD} = 0 mA		0.20	0.30	mA
I _{GND}	Ground Current	V _{AUX} is Selected, (V _{CC} /S _{BY} = 0 V) V _{CC} /S _{BY} = 5 V, I _{LOAD} = 0 mA V _{CC} /S _{BY} = 5 V, I _{LOAD} = 400 mA		0.20 0.80 1.00	0.30 1.50 2.00	mA
T _{DISABLE} T _{HYST}	Shutdown Temperature Thermal Hysteresis			160 20		°C

1. Operating characteristics are over Standard Operating Conditions unless otherwise specified.
2. The disturbance on V_{CC} during supply changeover should be kept below the hysteresis voltage to prevent any chatter. The source resistance on the V_{CC} supply should be kept to less than 0.3 Ω to ensure precise switching.

CMPWR330

PERFORMANCE INFORMATION

CMPWR330 Typical DC Characteristics (nominal conditions unless specified otherwise)

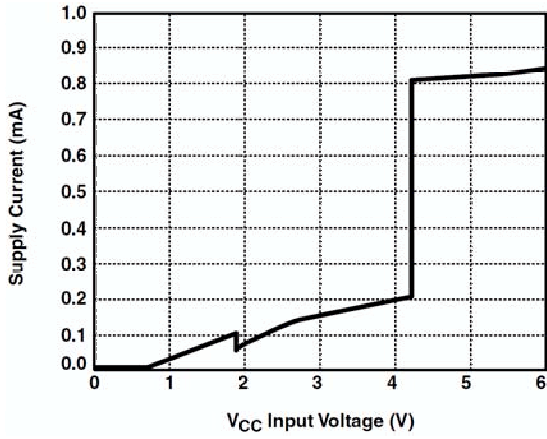

Figure 1. V_{CC} Supply Current vs. Voltage

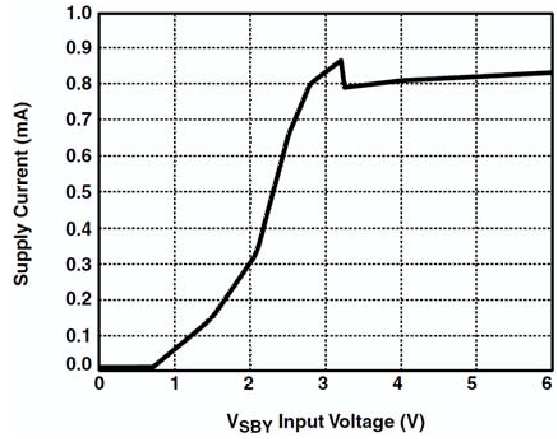

Figure 2. V_{SBY} Supply Current vs. Voltage

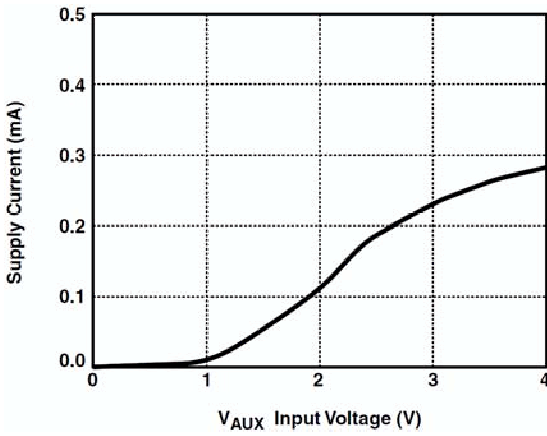

Figure 3. V_{AUX} Supply Current vs. Voltage

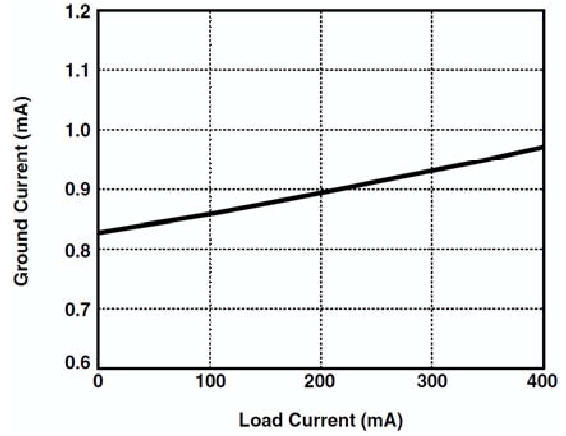

Figure 4. Ground Current vs. Output Load

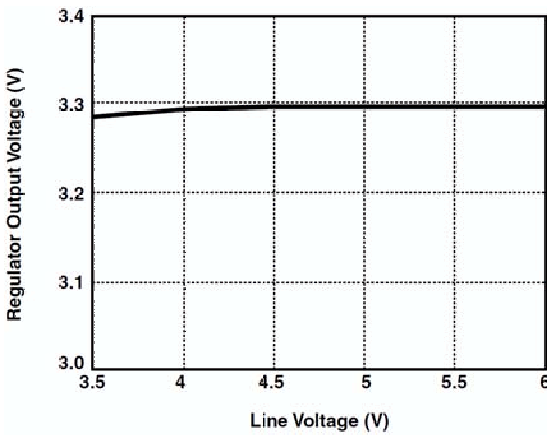

Figure 5. ???????????

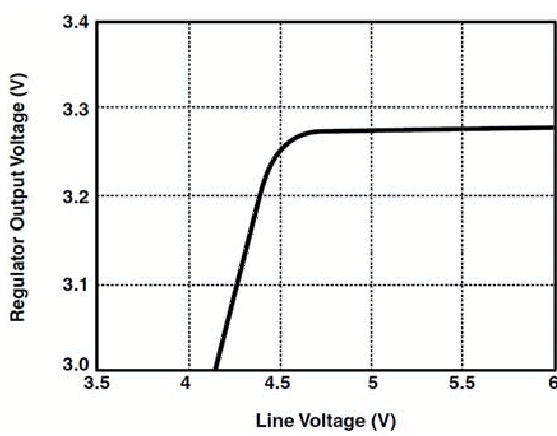

Figure 6. ???????????

CMPWR330

PERFORMANCE INFORMATION (Cont'd)

CMPWR330 Typical DC Characteristics (cont'd, nominal conditions unless specified otherwise)

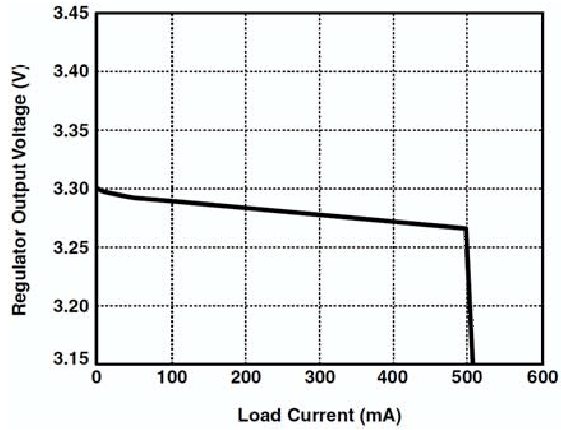

Figure 7. Load Regulation (5 V Supply)

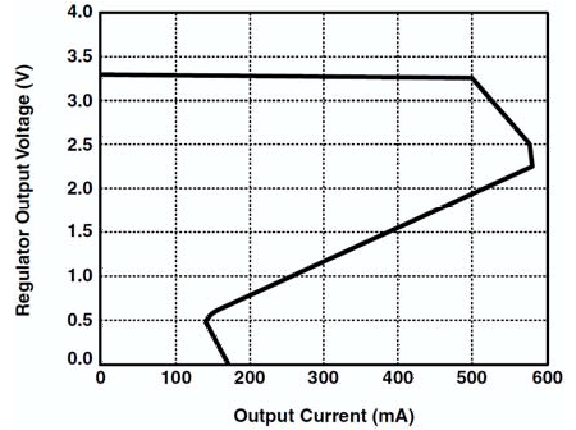

Figure 8. Foldback Current Limit Protection

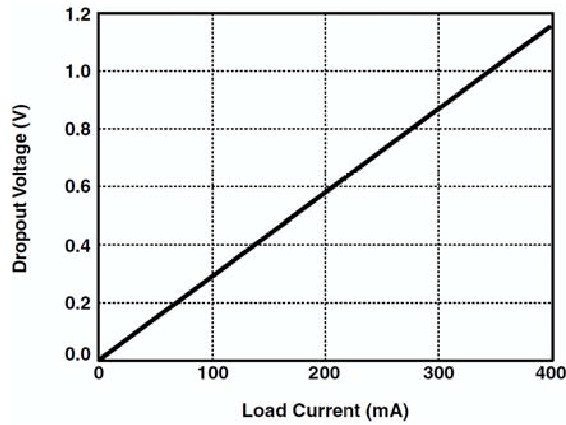

Figure 9. Regulation Dropout Characteristics

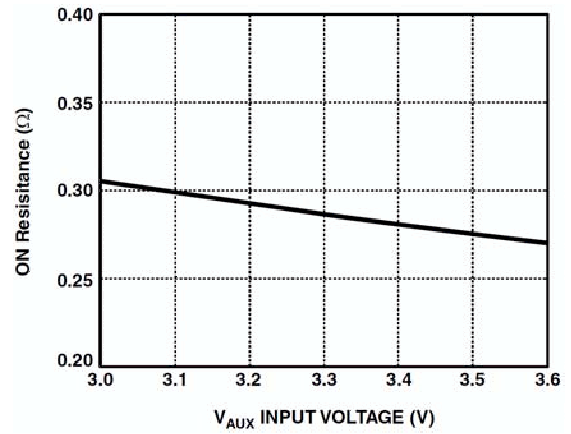

Figure 10. Switch Resistance vs. V_{AUX} Supply

CMPWR330

PERFORMANCE INFORMATION (Cont'd)

CMPWR330 Transient Characteristics (nominal conditions unless specified otherwise)
 (V_{CC} source resistance set to $0.2\ \Omega$)

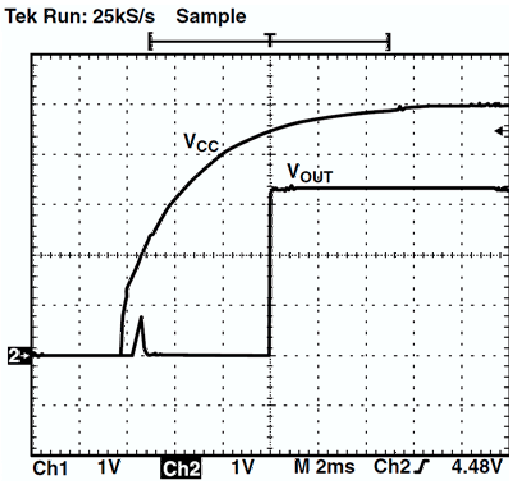

Figure 11. V_{CC} Cold Start (Load = 400 mA)

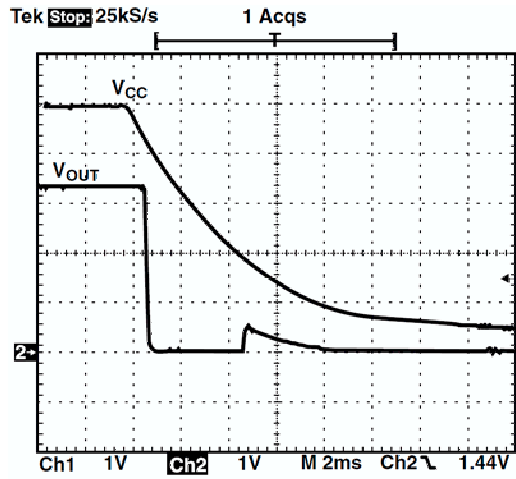

Figure 12. V_{CC} Full Power Down (Load = 400 mA)

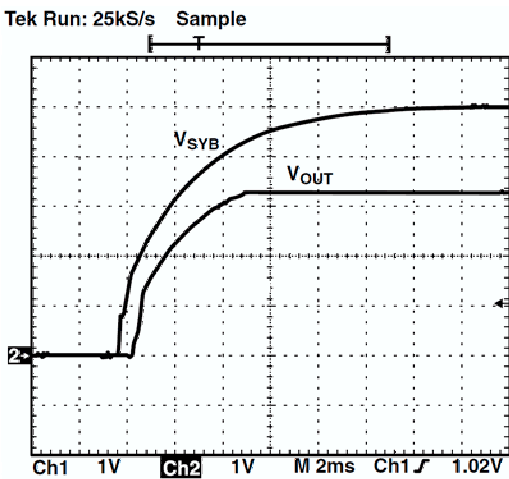

Figure 13. V_{SBY} Cold Start (Load = 400 mA)

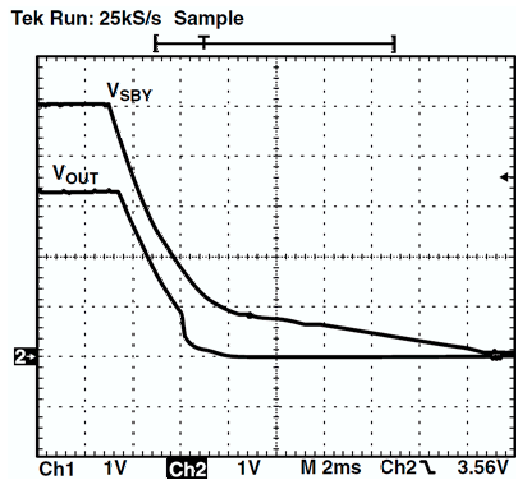

Figure 14. V_{SBY} Full Power Down (Load = 400 mA)

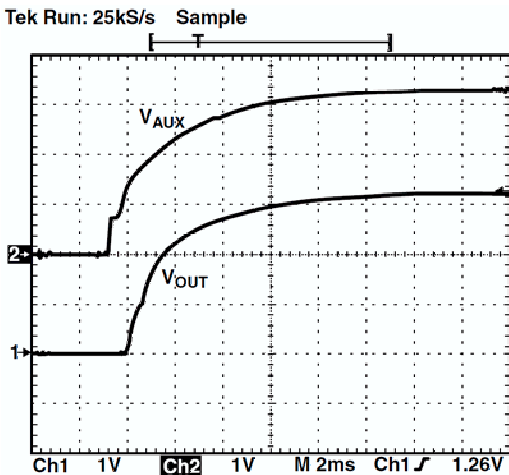

Figure 15. V_{AUX} Cold Start (Load = 400 mA)

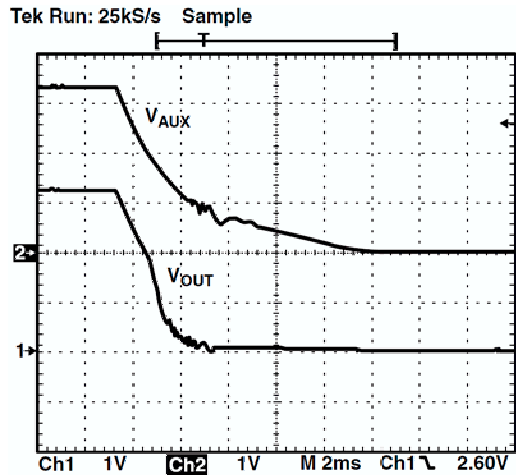

Figure 16. V_{AUX} Full Power Down (Load = 400 mA)

CMPWR330

PERFORMANCE INFORMATION (Cont'd)

CMPWR330 Transient Characteristics (cont'd; nominal conditions unless specified otherwise)
 (V_{CC} source resistance set to $0.2\ \Omega$)

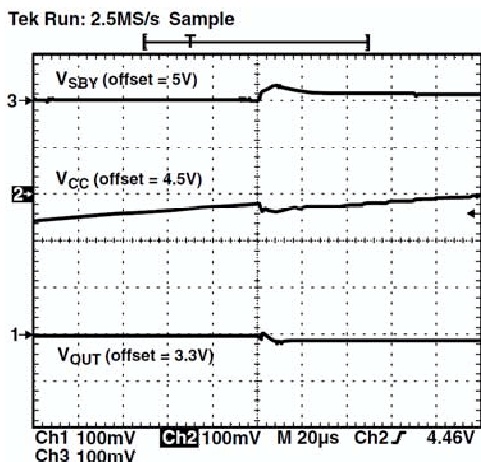

Figure 17. V_{CC} Power Up
 ($V_{SBY} = 5\text{ V}$, Load = 300 mA)

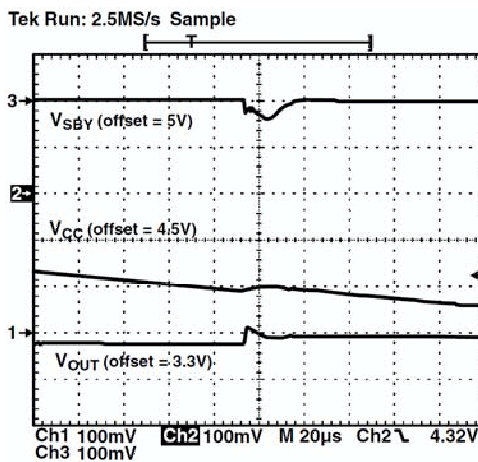

Figure 18. V_{CC} Power Down
 ($V_{SBY} = 5\text{ V}$, Load = 300 mA)

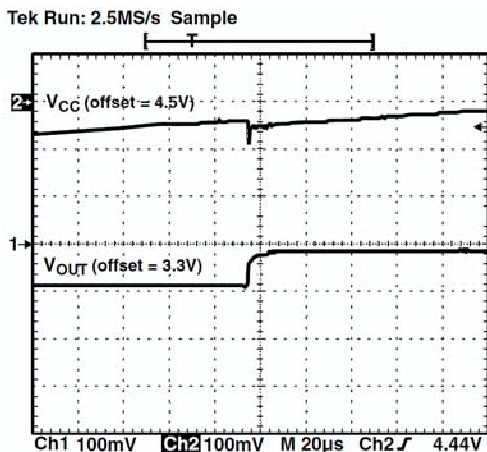

Figure 19. V_{CC} Power Up
 ($V_{AUX} = 3.3\text{ V}$, Load = 300 mA)

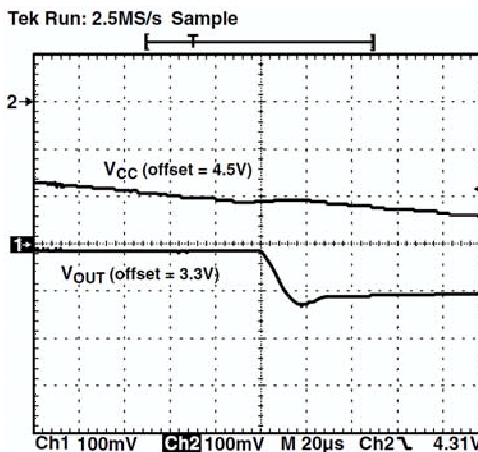

Figure 20. V_{CC} Power Down
 ($V_{AUX} = 3.3\text{ V}$, Load = 300 mA)

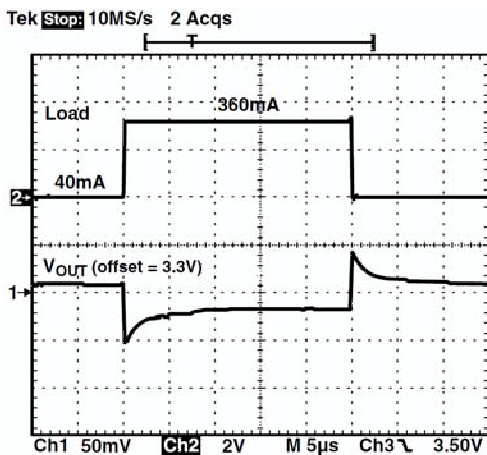

Figure 21. Load Transient Response
 (10% - 90% Rated)

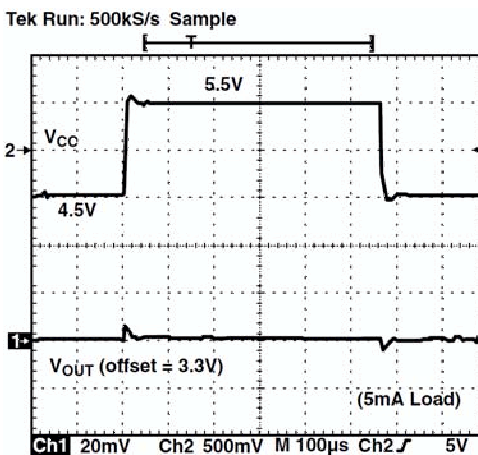

Figure 22. Line Transient (1 V_{PP}) Response

PERFORMANCE INFORMATION (Cont'd)

CMPWR330 Typical Thermal Characteristics

The overall junction to ambient thermal resistance (θ_{JA}) for device power dissipation (P_D) consists primarily of two paths in series. The first path is the junction to the case (θ_{JC}) which is defined by the package style, and the second path is case to ambient (θ_{CA}) thermal resistance which is dependent on board layout. The final operating junction temperature for any set of conditions can be estimated by the following thermal equation:

$$\begin{aligned} T_J &= T_A + (P_D)(\theta_{JC}) + (P_D)(\theta_{CA}) \\ &= T_A + (P_D)(\theta_{JA}) \end{aligned}$$

The CMPWR330 uses a thermally enhanced package where all the GND leads (pins 5 through 8) are integral to the leadframe. When this package is mounted on a double-sided printed circuit board with two square inches of copper allocated for “heat spreading”, the resulting θ_{JA} is about 50°C/W.

Based on a typical operating power dissipation of 0.7 W (1.75 V x 0.4 A) with an ambient of 70°C, the resulting junction temperature will be:

$$\begin{aligned} T_J &= T_A + (P_D)(\theta_{JA}) \\ &= 70^\circ C + 0.7 W \times (50^\circ C/W) \\ &= 70^\circ C + 35^\circ C = 105^\circ C \end{aligned}$$

The thermal characteristics were measured using a double-sided board with two square inches of copper area connected to the GND pin for “heat spreading”.

Measurements showing performance up to junction temperature of 125°C were performed under light load conditions (5 mA). This allows the ambient temperature to be representative of the internal junction temperature.

NOTE: The use of multi-layer board construction with separate ground and power planes will further enhance the overall thermal performance. In the event of no copper area being dedicated for heat spreading, a multi-layer board construction, using only the minimum size pad layout, will provide the CMPWR330 with an overall θ_{JA} of 70°C/W which allows up to 780 mW to be safely dissipated for the maximum junction temperature.

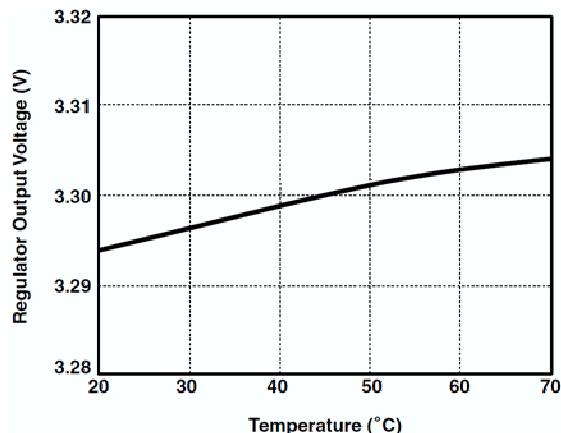

Figure 23. V_{OUT} Variation with T_{AMB} (400 mA Load)_T

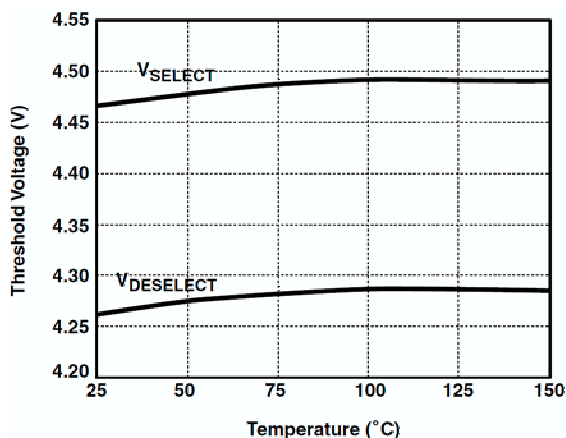

Figure 24. Select/Deselect Threshold Variation with T_{JUNC}

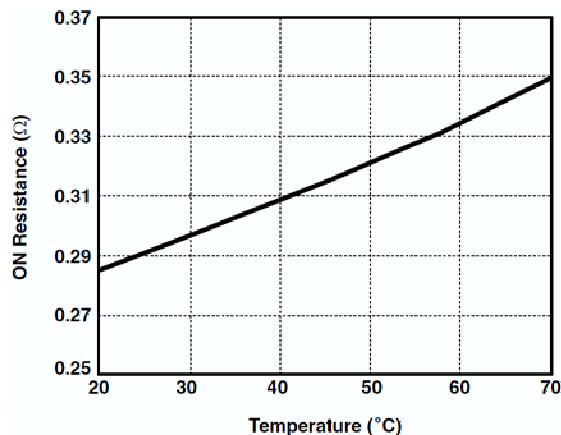
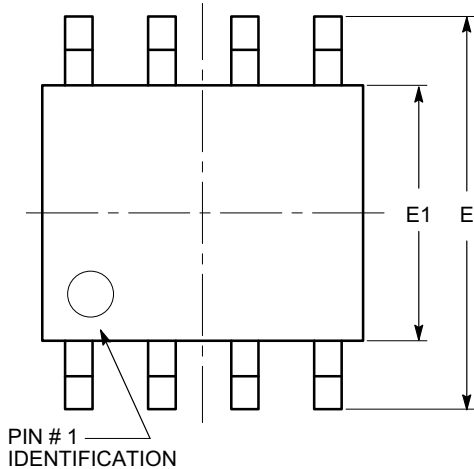

Figure 25. V_{AUX} Switch Resistance vs. T_{AMB}

CMPWR330

PACKAGE DIMENSIONS

SOIC 8, 150 mils
CASE 751BD-01
ISSUE O



TOP VIEW

SYMBOL	MIN	NOM	MAX
A	1.35		1.75
A1	0.10		0.25
b	0.33		0.51
c	0.19		0.25
D	4.80		5.00
E	5.80		6.20
E1	3.80		4.00
e	1.27 BSC		
h	0.25		0.50
L	0.40		1.27
θ	0°		8°

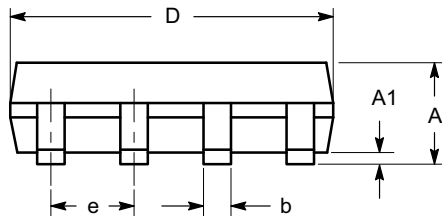

SIDE VIEW

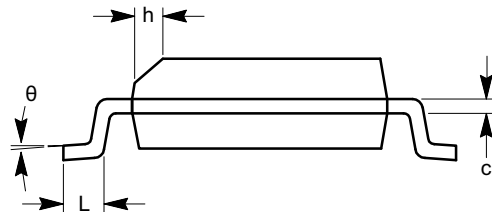

END VIEW

Notes:

- (1) All dimensions are in millimeters. Angles in degrees.
- (2) Complies with JEDEC MS-012.

SmartOR is a trademark of Semiconductor Components Industries, LLC (SCILLC).

ON Semiconductor and  are registered trademarks of Semiconductor Components Industries, LLC (SCILLC). SCILLC reserves the right to make changes without further notice to any products herein. SCILLC makes no warranty, representation or guarantee regarding the suitability of its products for any particular purpose, nor does SCILLC assume any liability arising out of the application or use of any product or circuit, and specifically disclaims any and all liability, including without limitation special, consequential or incidental damages. "Typical" parameters which may be provided in SCILLC data sheets and/or specifications can and do vary in different applications and actual performance may vary over time. All operating parameters, including "Typicals" must be validated for each customer application by customer's technical experts. SCILLC does not convey any license under its patent rights nor the rights of others. SCILLC products are not designed, intended, or authorized for use as components in systems intended for surgical implant into the body, or other applications intended to support or sustain life, or for any other application in which the failure of the SCILLC product could create a situation where personal injury or death may occur. Should Buyer purchase or use SCILLC products for any such unintended or unauthorized application, Buyer shall indemnify and hold SCILLC and its officers, employees, subsidiaries, affiliates, and distributors harmless against all claims, costs, damages, and expenses, and reasonable attorney fees arising out of, directly or indirectly, any claim of personal injury or death associated with such unintended or unauthorized use, even if such claim alleges that SCILLC was negligent regarding the design or manufacture of the part. SCILLC is an Equal Opportunity/Affirmative Action Employer. This literature is subject to all applicable copyright laws and is not for resale in any manner.

PUBLICATION ORDERING INFORMATION

LITERATURE FULFILLMENT:
Literature Distribution Center for ON Semiconductor
P.O. Box 5163, Denver, Colorado 80217 USA
Phone: 303-675-2175 or 800-344-3860 Toll Free USA/Canada
Fax: 303-675-2176 or 800-344-3867 Toll Free USA/Canada
Email: orderlit@onsemi.com

N. American Technical Support: 800-282-9855 Toll Free USA/Canada
Europe, Middle East and Africa Technical Support:
Phone: 421 33 790 2910
Japan Customer Focus Center
Phone: 81-3-5773-3850

ON Semiconductor Website: www.onsemi.com
Order Literature: <http://www.onsemi.com/orderlit>
For additional information, please contact your local Sales Representative