



ULTRA COMPACT CHIP ANTENNA DATA GUIDE

DESCRIPTION

The exciting ANT-***-CHP family is among the world's smallest high-performance chip antennas. They are ideal for embedding in wireless products including Bluetooth, 802.11, Home RF, ZigBee and other popular standards. These tiny antennas use advanced Low Temperature Co-fired Ceramic (LTCC) technology and proprietary elements to achieve superior size and performance characteristics. The entire family is compatible with hand- and reflow-assembly. Excellent electrical specifications, stability, and outstanding cost-effectiveness make CHP Series antennas the logical choice for a wide variety of applications.

FEATURES

- Incredibly compact SMD package
- Superior LTCC technology
- 50Ω characteristic impedance
- Low loss
- Wide bandwidth
- Favorable linear polarization
- > Unity gain
- No external matching required
- Highly stable over temperature & time
- Hand- and reflow-assembly compatible
- RoHS compliant
- Cost-effective

APPLICATIONS

- Bluetooth
- 802.11
- ZigBee
- Wireless PCMCIA Cards
- Telemetry
- Data Collection
- Industrial Process Monitoring
- Compact Wireless Products
- External Antenna Elimination

PHYSICAL DIMENSIONS

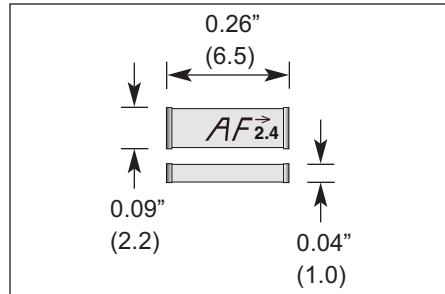

2.45GHz Version

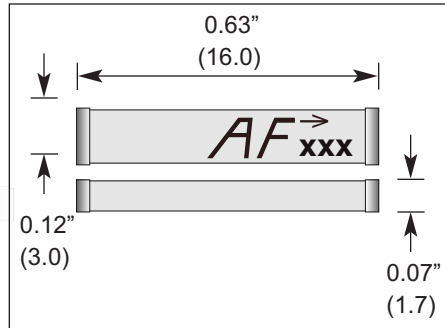

868 / 916MHz Versions

ACTUAL SIZE

2.45GHz



ORDERING INFORMATION

PART #	DESCRIPTION
ANT-868-CHP-x	868MHz Chip Antenna
ANT-916-CHP-x	916MHz Chip Antenna
ANT-2.45-CHP-x	2.45GHz Chip Antenna

x = "T" for Tape/Reel, "B" for Bulk

All parts are RoHS compliant.
Standard reel is 3,000pcs. (868/916MHz)
1,500pcs (2.45GHz)
Quantities less than reel size are supplied in bulk.

SPECIFICATIONS

PHYSICAL SPECIFICATIONS

	2.45GHz	868MHz	916MHz
Dimensions (mm)	6.5(L) x 2.2(W) x 1.0(H)	16.0(L) x 3.0(W) x 1.7(H)	16.0(L) x 3.0(W) x 1.7(H)
Operating/Storage Temp	-40 ~ +85°C	-40 ~ +85°C	-40 ~ +85°C
Construction	LTCC	LTCC	LTCC

ELECTRICAL PERFORMANCE

	2.45GHz	868MHz	916MHz
Center Frequency	2.45GHz	868MHz	916MHz
Bandwidth	180MHz	10MHz	10MHz
Wavelength	1/4-wave	1/4-wave	1/4-wave
Pattern	Omni-directional	Omni-directional	Omni-directional
Polarization	Linear	Linear	Linear
VSWR	≤2.0 (Max.)	≤2.0 (Max.)	≤2.0 (Max.)
Maximum Gain	+0.5dBi	+0.5dBi	+0.5dBi
Impedance	50Ω	50Ω	50Ω
Power Handling	3W (Max.)	3W (Max.)	3W (Max.)

2.4GHz FOOTPRINT

868 & 916MHz FOOTPRINT

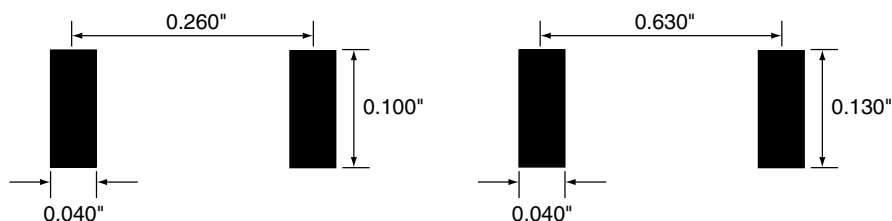

PIN CONFIGURATION



Pin Number	Pin Description
1	Feed Termination This pin connects to the transmitter or receiver
2	Solder Termination This pin is soldered down for physical support only. There is no electrical connection

THEORY OF OPERATION

The CHP Series antennas utilize Low Temperature Cofired Ceramic (LTCC) technology to embed the antenna element into a ceramic substrate. Advances in this technology have resulted in materials that are extremely stable over time and temperature, producing an antenna that is highly reliable across a wide range of applications. The high-frequency characteristics of this technology enable exceptional performance in a very small package. The construction techniques for LTCC devices lends itself well to favorable pricing in high volume.

LAYOUT CONSIDERATIONS

Proper layout is vital to ensure correct operation and optimum performance. Improper placement of planes, traces, or system components will result in nulls or complete de-tuning. Ideally, the antenna will be mounted on the board in such a way as to allow an unobstructed field of view. The area underneath the antenna must be free of components, traces, and planes. Components may be placed to the rear of the antenna in the ground plane counterpoise area. The feed trace from the RF stage to the antenna must be a microstrip trace or coax transmission line and should be kept as short as practical.

The layout of our reference jigs is illustrated on the following pages. While they demonstrate various aspects of a layout, it is not necessary to replicate them exactly. While your board size and layout may differ, it is important to recognize that the counterpoise plays an important role in resonance and stability since it acts, in essence, as part of the antenna. After your own layout is complete, the performance of the antenna in your specific product should be carefully checked using tools like a network analyzer. In some cases, the size of the product's PCB, proximity of the case, or other factors may make a custom version of the antenna necessary. Contact Antenna Factor for more information.

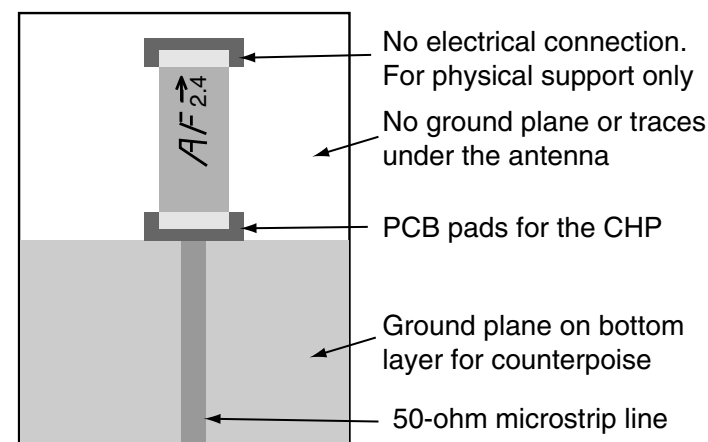

MICROSTRIP DETAILS

A transmission line is a medium whereby RF energy is transferred from one place to another with minimal loss. This is a critical factor, especially in high-frequency products, because the trace leading to the antenna can effectively contribute to the length of the antenna, changing its resonant bandwidth. In order to minimize loss and detuning, some form of transmission line between the antenna and the RF stage should be used, unless the antenna can be placed very close (<1/8in.) to the RF stage. One common form of transmission line is a coax cable, another is the microstrip. This term refers to a PCB trace running over a ground plane that is designed to serve as a transmission line between the RF stage and the antenna. The width is based on the desired characteristic impedance of the line, the thickness of the PCB, and the dielectric constant of the board material. For standard 0.062in-thick FR-4 board material, the trace width would be 111 mils. The correct trace width can be calculated for other widths and materials using the information below. Handy software for calculating microstrip lines is also available on the Antenna Factor website, www.antennafactor.com.

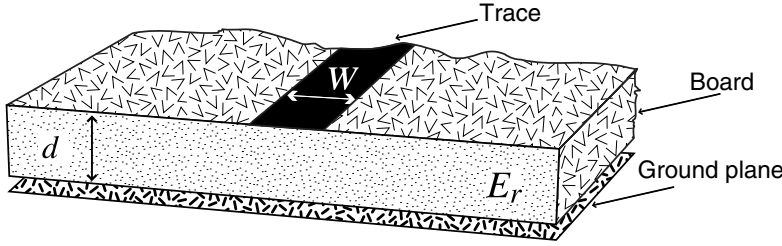

The diagram shows a 3D perspective of a microstrip line. A top layer of dielectric material with thickness d and dielectric constant E_r contains a trace of width W . Below this is a ground plane. The effective dielectric constant E_e and characteristic impedance Z_0 are defined by the following equations:

$$E_e = \frac{E_r + 1}{2} + \frac{E_r - 1}{2} \cdot \frac{1}{\sqrt{1 + 12d/W}}$$

$$Z_0 = \begin{cases} \frac{60}{\sqrt{E_e}} \cdot \ln\left(\frac{8d}{W} + \frac{W}{4d}\right) & \text{For } \frac{W}{d} \leq 1 \\ \frac{120\pi}{\sqrt{E_e} \cdot \left(\frac{W}{d} + 1.393 + 0.667 \cdot \ln\left(\frac{W}{d} + 1.444\right)\right)} & \text{For } \frac{W}{d} \geq 1 \end{cases}$$

E_r = Dielectric constant of PCB material

Dielectric Constant	Width/Height (W/d)	Effective Dielectric Constant	Characteristic Impedance
4.80	1.8	3.59	50.0
4.00	2.0	3.07	51.0
2.55	3.0	2.12	48.0

ASSEMBLY CONSIDERATIONS

The antenna is RoHS Compliant and designed to support hand or automated assembly. To avoid damage to the part, the reflow solder guidelines found below should be carefully followed. The antenna is single ended meaning that one pad is electrically connected while the other is for mechanical support only. The antenna terminals are not interchangeable so the polarity indicated in the Pin Configuration section must be observed during assembly.

Hand Soldering

This antenna is designed for high-volume automated assembly, however, it may be successfully attached by hand assembly techniques. A hand-solder temperature of 225°C or lower should be used. Do not exceed a 10sec. heating time.

Reflow Temperature Profile

The single most critical stage in the automated assembly process is the reflow process. The reflow profile below should be closely followed since excessive temperatures or transport times during reflow will irreparably damage the antennas. Assembly personnel will need to pay careful attention to the oven's profile to ensure that it meets the requirements necessary to successfully reflow all components while still meeting the limits mandated by the antennas themselves.

MAXIMUM REFLOW SOLDERING PROFILE

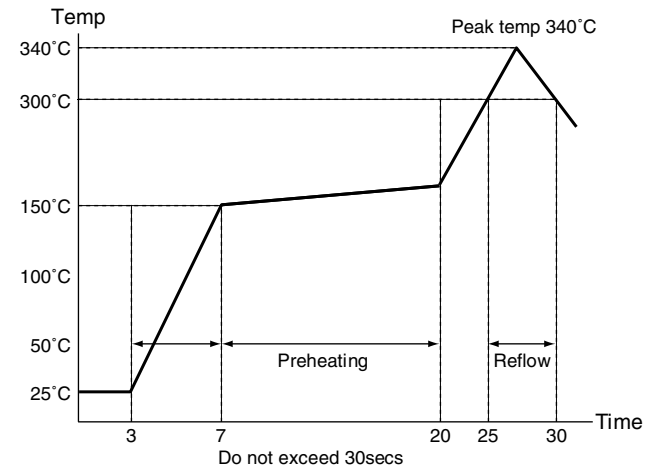

Absolute Maximum Solder Times

Hand-Solder Temp. TX +225°C for 10 Sec.
Hand-Solder Temp. RX +225°C for 10 Sec.
Recommended Solder Melting Point +180°C
Reflow Oven: +340°C Max. (See adjoining diagram)

2.4GHZ TEST BOARD

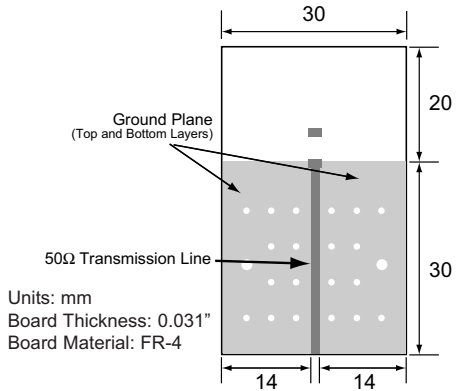

2.4GHz TYPICAL VSWR

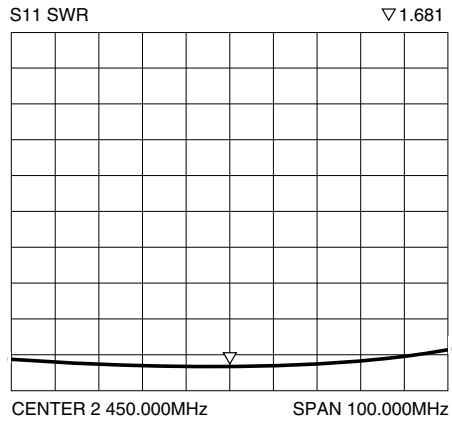

2.4GHz TAPE DIMENSIONS



868 & 916MHz TEST BOARD

Board Thickness: 0.062"
Board Material: FR-4

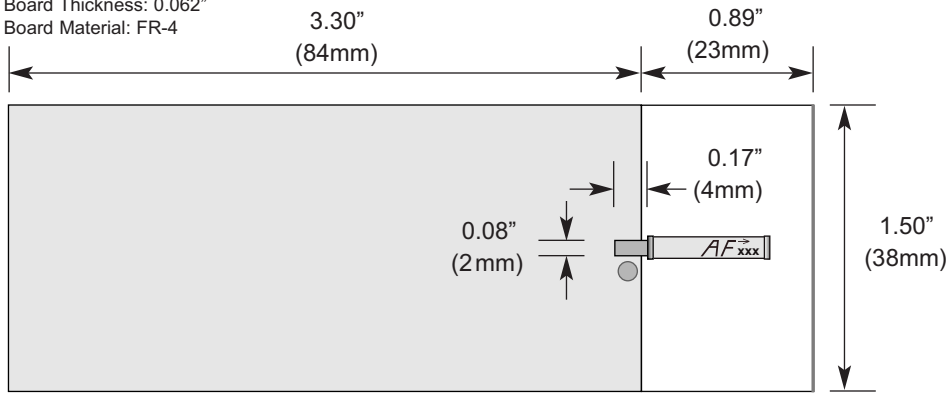

868MHz TYPICAL VSWR

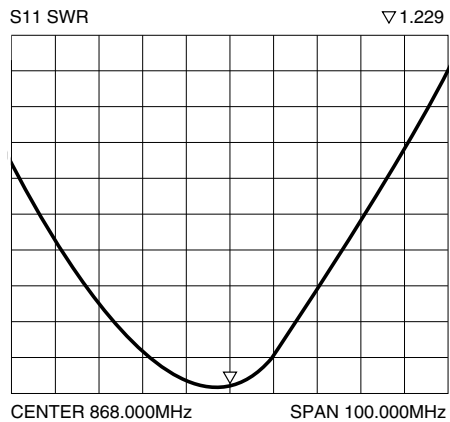

916MHz TYPICAL VSWR

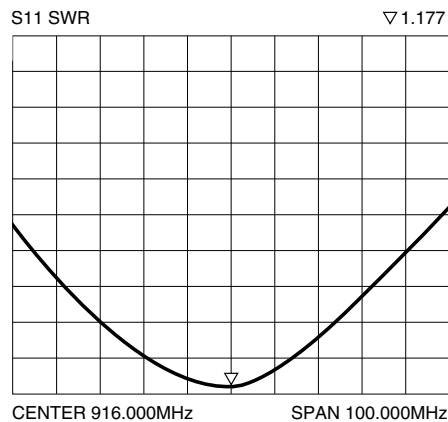

Symbol	Dimension	Tolerance	Unit
A0	2.30	±0.10	mm
D1	1.50	+0.10 -0.00	mm
D2	1.50	+0.25 -0.00	mm
F	6.60	±0.10	mm
P1	8.00	±0.10	mm
P2	7.50	±0.10	mm
P3	1.75	±0.10	mm
P4	4.00	±0.10	mm
P5	2.00	±0.10	mm
T2	0.30	±0.05	mm
T4	1.30	±0.10	mm
W	16.00	±0.10	mm

868MHz AND 916MHz TAPE DIMENSIONS



Symbol	Dimension	Tolerance	Unit
D1	1.50	±0.10	mm
D2	1.50	±0.10	mm
F	10.6	±0.10	mm
P1	8.00	±0.10	mm
P2	11.50	±0.10	mm
P3	1.75	±0.10	mm
P4	4.00	±0.10	mm
P5	2.00	±0.10	mm
T2	0.30	±0.05	mm
T3	3.30	±0.10	mm
T4	1.90	±0.10	mm
W	24.00	±0.30	mm

REEL DIMENSIONS



Symbol	868/916MHz	2.45GHz	Unit
QTY per Reel	3,000	1,500	pcs
Tape Width	24	16	mm
A	330±1	180±1	mm
B	100±0.5	62±0.5	mm
C	13±0.5	13±0.2	mm
E	2.2±0.5	2.2±0.5	mm
W	24±0.5	16±0.5	mm
W1	28.9±0.2	20±0.2	mm

MISMATCH CONVERSION TABLE

VSWR	Insertion Loss (dB)	Power Transmtd (%)	Power Reflected (%)
17.391	-6.87	20.57%	79.43%
11.610	-5.35	29.21%	70.79%
8.724	-4.33	36.90%	63.10%
6.997	-3.59	43.77%	56.23%
5.848	-3.02	49.88%	50.12%
5.030	-2.57	55.33%	44.67%
4.419	-2.20	60.19%	39.81%
3.946	-1.90	64.52%	35.48%
3.570	-1.65	68.38%	31.62%
3.010	-1.26	74.88%	25.12%
2.615	-0.97	80.05%	19.95%
2.323	-0.75	84.15%	15.85%
2.100	-0.58	87.41%	12.59%
1.925	-0.46	90.00%	10.00%
1.433	-0.14	96.84%	3.16%
1.222	-0.04	99.00%	1.00%
1.119	-0.01	99.68%	0.32%
1.065	0.00	99.90%	0.10%
1.034	0.00	99.97%	0.03%
1.020	0.00	99.99%	0.01%

ON-LINE RESOURCES



www.antennafactor.com

- Latest News
- Data Guides
- Application Notes
- Knowledge Base
- Custom Antennas



The Antenna Factor division of Linx offers a diverse array of antenna styles, many of which are optimized for use with our RF modules. From innovative embeddable antennas to low-cost whips, domes to Yagi's, and even GPS, it is likely that Antenna Factor has an antenna to meet your requirements or can assist you with a custom antenna tailored to your needs. Day or night, our corporate website provides a ready resource for the latest information and support of our many products.



www.connectorcity.com

Through its Connector City division, Linx offers a wide selection of high-quality RF connectors, including FCC-compliant types such as RP-SMA that are an ideal match for our modules and antennas. Connector City focuses on high-volume OEM requirements, which allows standard and custom RF connectors to be offered at a remarkably low cost.





U.S. CORPORATE HEADQUARTERS

ANTENNA FACTOR, INC.

**159 ORT LANE
MERLIN, OR 97532**

PHONE: (541) 956-0931

FAX: (541) 471-6251

www.antennafactor.com

Disclaimer

Linx Technologies is continually striving to improve the quality and function of its products. For this reason, we reserve the right to make changes to our products without notice. The information contained in this Overview Guide is believed to be accurate as of the time of publication. Specifications are based on representative lot samples. Values may vary from lot-to-lot and are not guaranteed. "Typical" parameters can and do vary over lots and application. Linx Technologies makes no guarantee, warranty, or representation regarding the suitability of any product for use in any specific application. It is the customer's responsibility to verify the suitability of the part for the intended application. NO LINX PRODUCT IS INTENDED FOR USE IN ANY APPLICATION WHERE THE SAFETY OF LIFE OR PROPERTY IS AT RISK.

Linx Technologies DISCLAIMS ALL WARRANTIES OF MERCHANTABILITY AND FITNESS FOR A PARTICULAR PURPOSE. IN NO EVENT SHALL LINX TECHNOLOGIES BE LIABLE FOR ANY OF CUSTOMER'S INCIDENTAL OR CONSEQUENTIAL DAMAGES ARISING IN ANY WAY FROM ANY DEFECTIVE OR NON-CONFORMING PRODUCTS OR FOR ANY OTHER BREACH OF CONTRACT BY LINX TECHNOLOGIES. The limitations on Linx Technologies' liability are applicable to any and all claims or theories of recovery asserted by Customer, including, without limitation, breach of contract, breach of warranty, strict liability, or negligence. Customer assumes all liability (including, without limitation, liability for injury to person or property, economic loss, or business interruption) for all claims, including claims from third parties, arising from the use of the Products. The Customer will indemnify, defend, protect, and hold harmless Linx Technologies and its officers, employees, subsidiaries, affiliates, distributors, and representatives from and against all claims, damages, actions, suits, proceedings, demands, assessments, adjustments, costs, and expenses incurred by Linx Technologies as a result of or arising from any Products sold by Linx Technologies to Customer. Under no conditions will Linx Technologies be responsible for losses arising from the use or failure of the device in any application, other than the repair, replacement, or refund limited to the original product purchase price. Devices described in this publication may contain proprietary, patented, or copyrighted techniques, components, or materials. Under no circumstances shall any user be conveyed any license or right to the use or ownership of such items.
