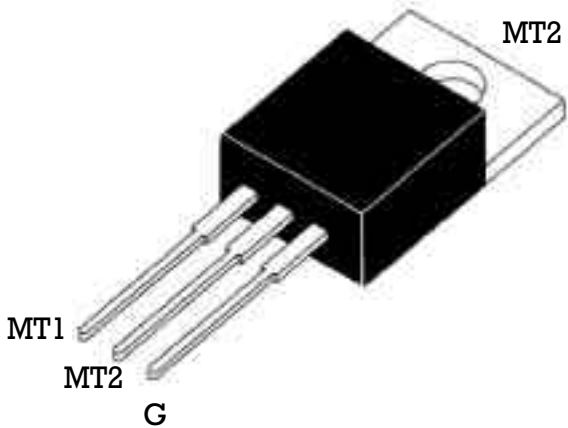

LOGIC LEVEL TRIAC

<p>TO220-AB</p> 	<p>On-State Current 6 Amp</p> <p>Gate Trigger Current 5 mA to 10 mA</p> <p>Off-State Voltage 200 V ÷ 600 V</p>
<p>This series of TRIACs uses a high performance PNP technology.</p> <p>These parts are intended for general purpose AC switching applications with highly inductive loads.</p>	

Absolute Maximum Ratings, according to IEC publication No. 134

SYMBOL	PARAMETER	CONDITIONS	Min.	Max.	Unit
$I_{T(RMS)}$	RMS On-state Current	All Conduction Angle, $T_C = 110\text{ }^\circ\text{C}$	6		A
I_{TSM}	Non-repetitive On-State Current	Full Cycle, 60 Hz	63		A
I_{TSM}	Non-repetitive On-State Current	Full Cycle, 50 Hz	60		A
I^2t	Fusing Current	$t = 10\text{ ms}$, Half Cycle	31		A ² s
I_{GM}	Peak Gate Current	$20\text{ }\mu\text{s max.}$ $T_j = 125\text{ }^\circ\text{C}$		4	A
$P_{G(AV)}$	Average Gate Power Dissipation	$T_j = 125\text{ }^\circ\text{C}$		1	W
di/dt	Critical rate of rise of on-state current	$I_G = 2 \times I_{GT}$, $t_r = 100\text{ ns}$ $f = 120\text{ Hz}$, $T_j = 125\text{ }^\circ\text{C}$	50		A/ μs
T_j	Operating Temperature		-40	+125	$^\circ\text{C}$
T_{stg}	Storage Temperature		-40	+150	$^\circ\text{C}$

SYMBOL	PARAMETER	VOLTAGE			Unit
		B	D	M	
V_{DRM}	Repetitive Peak Off State Voltage	200	400	600	V
V_{RRM}					

LOGIC LEVEL TRIAC

Electrical Characteristics

SYMBOL	PARAMETER	CONDITIONS	Quadrant		SENSITIVITY		Unit
					07	08	
$I_{GT}^{(1)}$	Gate Trigger Current	$V_D = 12 V_{DC}$, $R_L = 30$ $T_j = 25\text{ }^\circ\text{C}$	Q1÷Q3 Q4	MAX	5 7	10	mA mA
I_{DRM} / I_{RRM}	Off-State Leakage Current	$V_R = V_{RRM}$, $T_j = 125\text{ }^\circ\text{C}$ $T_j = 25\text{ }^\circ\text{C}$		MAX MAX		1 5	mA μA
$V_{IO}^{(2)}$	Threshold Voltage	$T_j = 125\text{ }^\circ\text{C}$		MAX		0.85	V
$R_d^{(2)}$	Dynamic Resistance	$T_j = 125\text{ }^\circ\text{C}$		MAX		60	m
$V_{TM}^{(2)}$	On-state Voltage	$I_T = 5.5\text{ Amp}$, $t_p = 380\text{ }\mu\text{s}$, $T_j = 25\text{ }^\circ\text{C}$		MAX		1.55	V
V_{GT}	Gate Trigger Voltage	$V_D = 12 V_{DC}$, $R_L = 30$, $T_j = 25\text{ }^\circ\text{C}$		MAX		1.3	V
V_{GD}	Gate Non Trigger Voltage	$V_D = V_{DRM}$, $R_L = 3.3K$, $T_j = 125\text{ }^\circ\text{C}$	Q1÷Q3	MIN		0.2	V
$I_H^{(2)}$	Holding Current	$I_T = 100\text{ mA}$, Gate open, $T_j = 25\text{ }^\circ\text{C}$		MAX	10	15	mA
I_L	Latching Current	$I_G = 1.2 I_{GT}$, $T_j = 25\text{ }^\circ\text{C}$	Q1,Q3 Q2	MAX MAX	10 15	25 30	mA
$dv / dt^{(2)}$	Critical Rate of Voltage Rise	$V_D = 0.67 \times V_{DRM}$, Gate open $T_j = 125\text{ }^\circ\text{C}$		MIN	20	40	V/ μs
$(dI/dt)c^{(2)}$	Critical Rate of Current Rise	$(dv/dt)c = 0.1\text{ V}/\mu\text{s}$, $T_j = 125\text{ }^\circ\text{C}$ $(dv/dt)c = 10\text{ V}/\mu\text{s}$, $T_j = 125\text{ }^\circ\text{C}$ without snubber, $T_j = 125\text{ }^\circ\text{C}$		MIN MIN MIN	2.7 1.2 -	3.5 2.4 -	A/ms
$R_{th(j-c)}$	Thermal Resistance Junction-Case					1.8	$^\circ\text{C}/\text{W}$
$R_{th(j-a)}$	Thermal Resistance Junction-Ambient					60	$^\circ\text{C}/\text{W}$

(1) Minimum I_{GT} is guaranteed at 5% of I_{GT} max.

(2) For either polarity of electrode MT2 voltage with reference to electrode MT1.

PART NUMBER INFORMATION

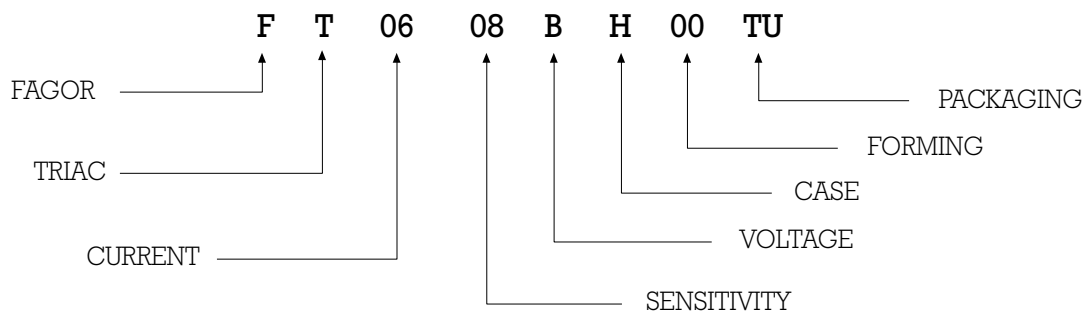

LOGIC LEVEL TRIAC

Fig. 1: Maximum power dissipation versus RMS on-state current (full cycle).

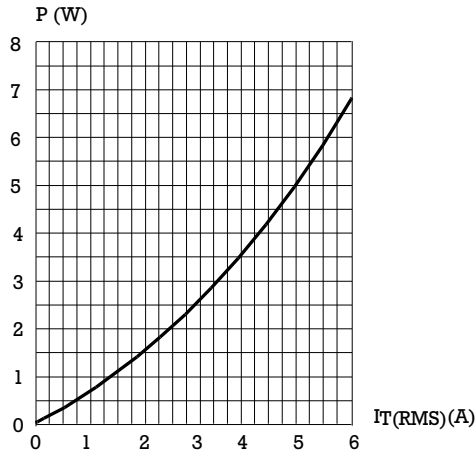

Fig. 3: : Relative variation of thermal impedance versus pulse duration.

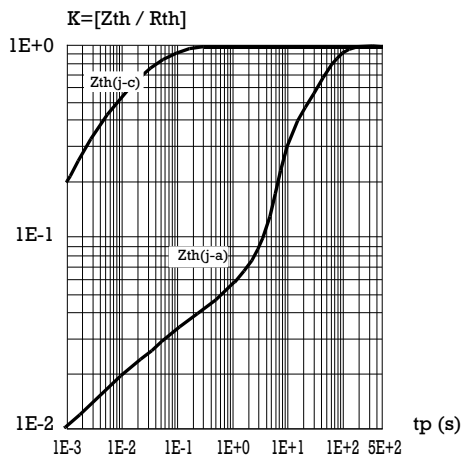

Fig. 5: Surge peak on-state current versus number of cycles

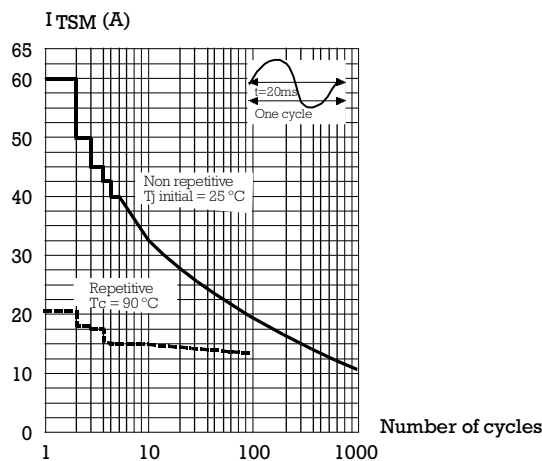

Fig. 2: RMS on-state current versus case temperature (full cycle).

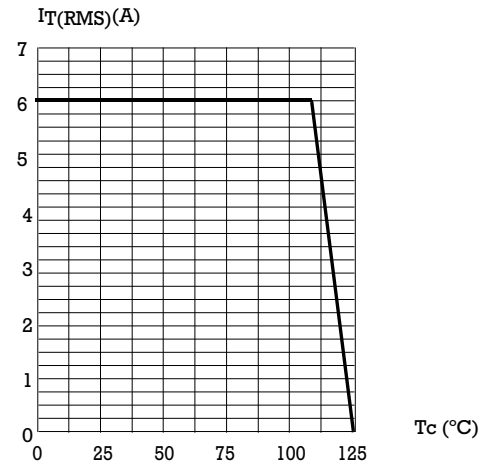

Fig. 4: On-state characteristics (maximum values)

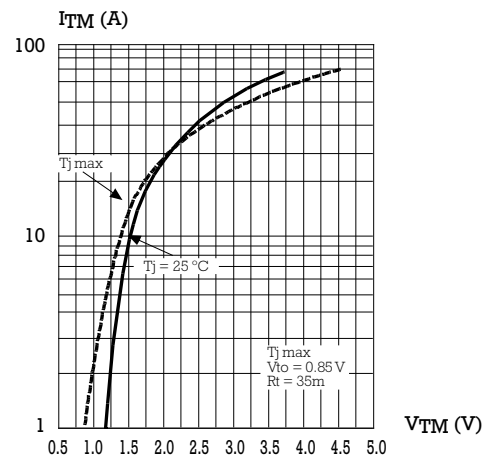
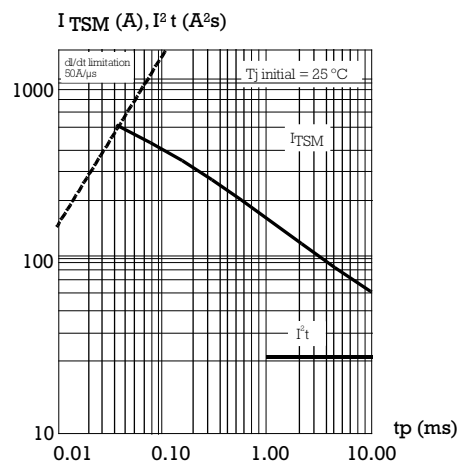

Fig. 6: Non-repetitive surge peak on-state current for a sinusoidal pulse with width $t_p < 10\text{ms}$, and corresponding value of $I^2 t$.



LOGIC LEVEL TRIAC

Fig. 7: Relative variation of gate trigger current, holding current and latching current versus junction temperature (typical values)

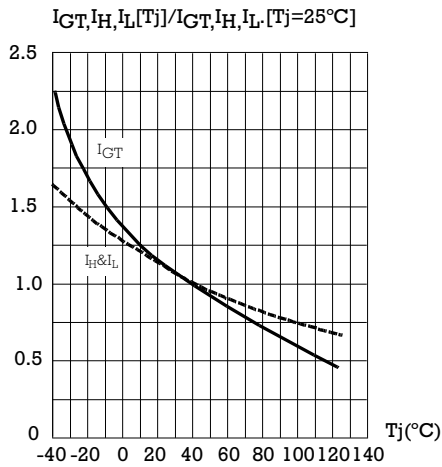
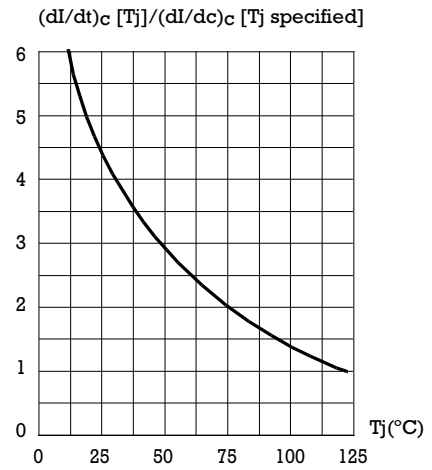

Fig. 8: Relative variation of critical rate of decrease of main current versus junction temperature



PACKAGE MECHANICAL DATA TO-220AB (Plastic)

