

SCHNITT A-A

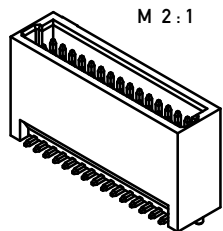

Abspulrichtung - Reel off Direction

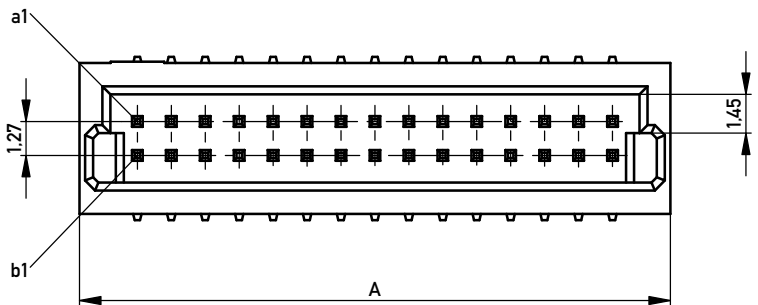
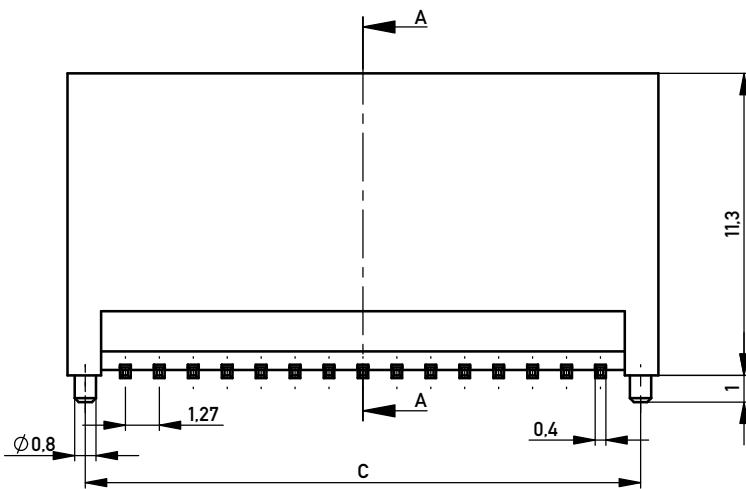
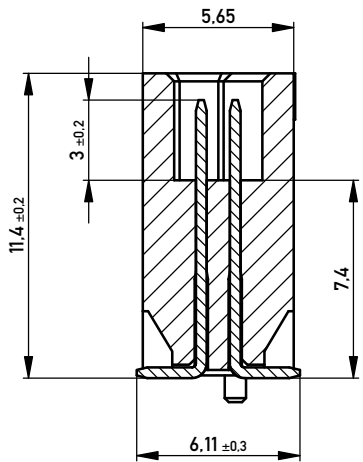
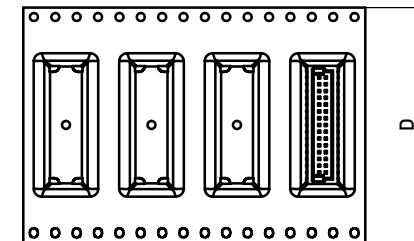

Verpackt in Gurtverpackung
Tape on Reel Packaging
Verpackungseinheit: 250 Stück
Packaging unit: 250pcs

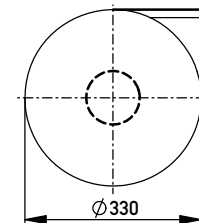

Verpackung Stange / Stange & Ansaughaube
packaging tube / tube & cap

100	9
80	11
70	12
60	14
50	17
40	21
30	27
20	38
10	64
Polzahl No. of positions	Stück / pieces

Masse und Toleranzen in Übereinstimmung mit ANSI Y15.5M-1994 /
Interpret dimensions according to ANSI Y15.5M-1994

109219	109210	109201	109192	109183	109174	100	66.56	62.23	65.23	88
109218	109209	109200	109191	109182	109173	80	53.86	49.53	52.53	72
109217	109208	109199	109190	109181	109172	70	47.51	43.18	46.18	72
109216	109207	109198	109189	109180	109171	60	41.16	36.83	39.83	56
109215	109206	109197	109188	109179	109170	50	34.81	30.48	33.48	56
109214	109205	109196	109187	109178	109169	40	28.46	24.13	27.13	44
109213	109204	109195	109186	109177	109168	30	22.11	17.78	20.78	44
109212	109203	109194	109185	109176	109167	20	15.76	11.43	14.43	32
109211	109202	109193	109184	109175	109166	10	9.41	5.08	8.08	24
Id-Nr. tape&reel 100 mating- cycles	Id-Nr. tape&reel 10 mating- cycles	Id-Nr. tube&cap 100 mating- cycles	Id-Nr. tube&cap 10 mating- cycles	Id-Nr. tube 100 mating- cycles	Id-Nr. tube 10 mating- cycles	Polzahl no of positions	Mass A	Mass B	Mass C	Mass D

Layout
M 2:1

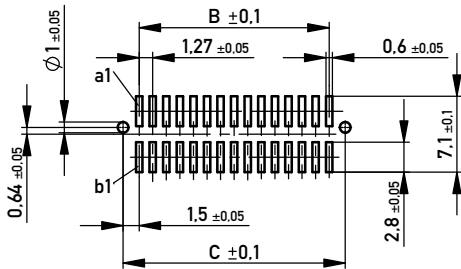

Bei Gurtverpackung ist Ansaughaube immer montiert.
Tape & reel packaging is always with assembly cap.

Copyright by ERNI GmbH
Proprietary notice pursuant to ISO 9006 to be observed.

Information:
All rights reserved.
Only for Information.
To ensure that this is the latest version of this drawing, please contact one of the ERNI companies before using.

Tolerances
Scale 5:1
Designation
MiniMez Vertical Male SMT with locating pegs 7,4mm
109165
www.ERNI.com
Class MINIMEZ

Index
Date
A3