

# MORNSUN®

## LH60-20BXX SERIES

### 60W, AC-DC CONVERTER

LH60-20BXX series ---- 60W converter offered by Mornsun. It features universal input voltage, both AC and DC input voltage, high efficiency, high reliability, low power consumption and safe isolation. It offers good EMC performance, which meet IEC/EN61000-4, CISPR22/EN55022, UL60950 and EN60950 standards, and it's widely used in industrial and electrical applications. For harsh EMC environment, the application circuit in the datasheet is strongly recommended.



#### PRODUCT FEATURES

1. Universal input range:90~264VAC/120~370VDC
2. AC and DC all in one (input from the same terminal)
3. Low standby power consumption, high efficiency,4000VAC safe isolation
4. low ripple and noise
5. Protection of input under-voltage, output short circuit, over-current, over-voltage
6. Perfect EMC performance, and EFT, surge meet level 4
7. Meet IEC61000, UL60950 and IEC60950 standards
8. 3 years product warranty

#### PART NUMBER SYSTEM

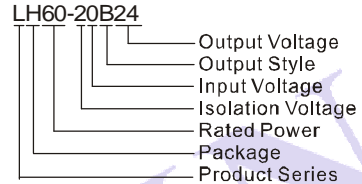

#### SELECTION GUIDE

Approval	Model	Package	Power	Output (Vo/Io)	Max. Capacitive Load	Ripple and Noise (Max.)	Efficiency (230VAC, Typ.)	Standby Power Consumption (Max.)
UL/CE	LH60-20B05	109.0*58.5*30.0mm	50W	5V/10A	80000µF	150mV	82%	0.5W
	LH60-20B05-DT							
	LH60-20B09		60W	9V/6.6A	28000µF		84%	
	*LH60-20B09-DT							
	LH60-20B12			12V/5A	14000µF		86%	
	LH60-20B12-DT							
	LH60-20B15			15V/4A	12000µF		86%	
	*LH60-20B15-DT							
	LH60-20B24			24V/2.5A	4000µF		86%	
	*LH60-20B24-DT							
LH60-20B48	48V/1.25A	1000µF	86%					
*LH60-20B48-DT								

Note: 1.\*Designing.  
2. There isn't input under voltage protection for LH60-20BXX-DT series.



#### INPUT SPECIFICATIONS

Item	Test Conditions	Min.	Typ.	Max.	Unit	
Input Voltage Range	LH60-20BXX(-DT)	AC Input	90	--	264	V
		DC Input	120	--	370	
Input Under Voltage Protection	LH60-20BXX	AC Input	65	--	90	
		DC Input	92	--	122	
		AC Input	55	--	75	
		DC Input	79	--	105	
Input Frequency		47	--	63	Hz	
Input Current	115VAC Input	--	--	1.4	A	
	230VAC Input	--	--	0.7		
Inrush Current	115VAC Input	--	30	--		
	230VAC Input	--	50	--		

## OUTPUT SPECIFICATIONS

Item	Test Conditions	Min.	Typ.	Max.	Unit
Output Voltage Accuracy		--	±2	--	%
Line Regulation	Full load	--	±0.5	--	
Load Regulation	5% to 100% Load	--	±1	--	
Ripple & Noise	20MHz bandwidth(p-p)	--	100	150	mV
Min Load		1	--	--	%
Trim		--	--	±10	
Hold-up Time	115VAC Input	--	15	--	ms
	230VAC Input	--	80	--	
Short Circuit Protection		Continuous, and auto recovery			
Over Current Protection		≥110% I <sub>o</sub> ,and auto recovery			
Over Voltage Protection		Zener diode clamp			

## COMMON SPECIFICATIONS

Item	Test Conditions	Min.	Typ.	Max.	Unit	
Operating Temperature		-40	--	+70	°C	
Storage Temperature		-40	--	+85		
Storage Humidity		--	--	95	%RH	
Temperature coefficient		--	±0.02	--	% / °C	
Power derating	-40°C ~ -30°C	4.0	--	--		
	+45°C ~ +70°C (5V, 9V Output)	3.0	--	--		
	+50°C ~ +70°C (12V, 15V Output)	2.5	--	--		
	+55°C ~ +70°C (24V, 48V Output)					
Isolation Resistance		100	--	--	MΩ	
Isolation Voltage	Input-Output	Tested for 1 minute	4000	--	--	VAC
	Input- 		1500	--	--	
	Output- 		500	--	--	
Switching Frequency		--	100	--	kHz	
Weight		--	310	--	g	
Welding Temperature	Wave-soldering	260 ± 5°C; time: 5~10s				
	Manual-welding	360 ± 10°C; time: 3~5s				
Safety approvals		EN60950/UL60950				
Safety Class		CLASS I				
Safety standards		IEC60950/EN60950/UL60950				
Hot swap		Forbid				
Case Material Grade		UL 94V-0				
Install		PCB				
Cooling		Free air convection				
MTBF		> 200000 h @ 25°C				

Note: 1. Ripple and Noise are measured by the method of parallel lines;

2. Unless otherwise specified, all specifications above are measured at rated input voltage and rated output load, T<sub>a</sub>=25°C, humidity < 75%.

## EMC SPECIFICATIONS

EMI	CE	CISPR22/EN55022, CLASS B				
	RE	CISPR22/EN55022, CLASS B				
EMS	ESD	IEC/EN61000-4-2	contact 6KV/Air 8KV		perf. Criteria B	
	RS	IEC/EN61000-4-3	10V/m		perf. Criteria A	
	EFT	IEC/EN61000-4-4	±4KV	(Without External Circuit )		perf. Criteria B
			±2KV/4KV	(Without External Circuit )		perf. Criteria B
	Surge	IEC/EN61000-4-5	±4KV/6KV	(Recommended Circuit Refer to Figure 3)		perf. Criteria B
			10 Vr.m.s			perf. Criteria A
	CS	IEC/EN61000-4-6	10 Vr.m.s			perf. Criteria A
	PFM	IEC/EN61000-4-8	10A/m			perf. Criteria A
Voltage dips, short and interruptions immunity	IEC/EN61000-4-11	0%-70%			perf. Criteria B	

The copyright and authority for the interpretation of the products are reserved by MORNSUN

Specifications subject to change without notice.

LH60-20BXX series

2013.08.28-A/2

Page 2 of 5

## PARALLEL LINES MEASURE

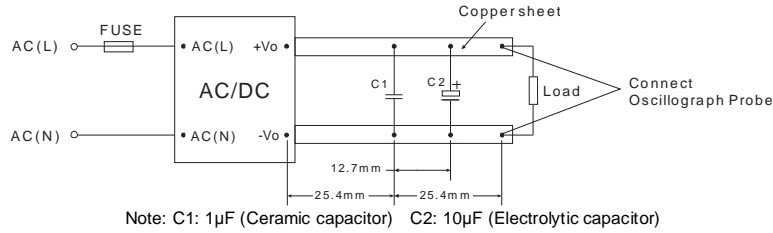

## PRODUCT TYPICAL CURVE

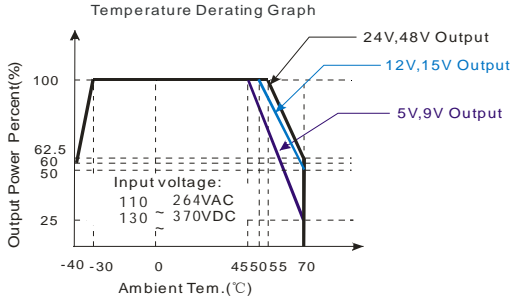

Note: When input 90~110VAC/77~130VDC, it need to be voltage derated on basis of temperature derating.

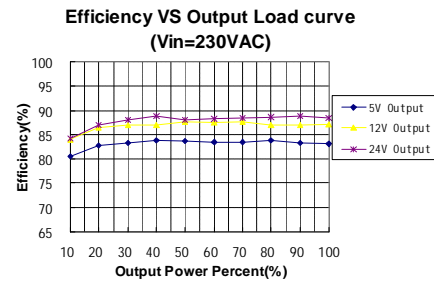
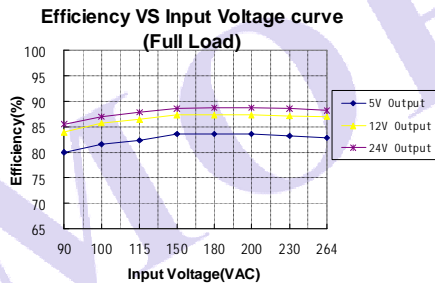
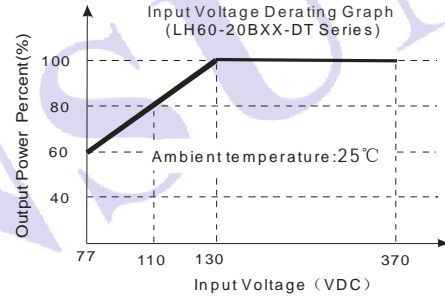
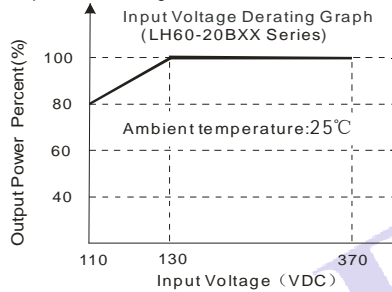
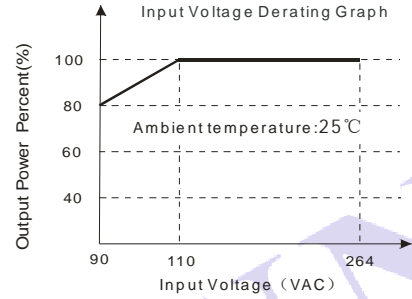

## TRIM APPLICATION & TRIM CALCULATION

### Application circuit for TRIM

(Part in broken line is the interior of models)

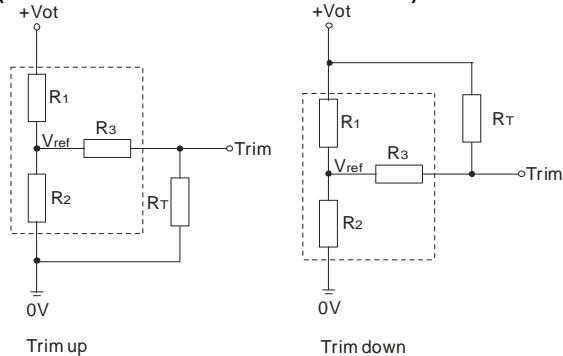

### Formula for resistance of Trim:

$$\text{up: } R_T = \frac{aR_2}{R_2 - a} - R_3 \quad a = \frac{V_{ref}}{V_{ot} - V_{ref}} \cdot R_1$$

$$\text{down: } R_T = \frac{aR_1}{R_1 - a} - R_3 \quad a = \frac{V_{ot} - V_{ref}}{V_{ref}} \cdot R_2$$

Note: Value for R1, R2, R3, and Vref refer to the following table.

R<sub>T</sub>: Resistance of Trim

a: User-defined parameter, no actual meanings.

Vo(V) Resistance	5	9	12	15	24	48
R1(KΩ)	3.3	4.7	3.83	7.5	8.66	33
R2(KΩ)	3.3	1.8	1	1.5	1	1.8
R3(KΩ)	1	1	1	1	1	1
Vref(V)	2.5	2.5	2.5	2.5	2.5	2.5
Vot(V)	Output voltage of Trim, variation $\pm 10\%$					

## TYPICAL APPLICATIONS

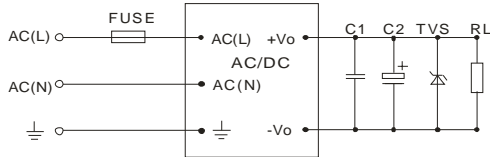

(Figure 1): Typical application circuit

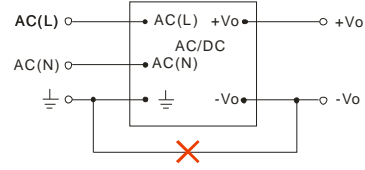

(Figure 2): This application is not available for this series.  
Note: If you have such application, please consult to our FAE department

## EMC RECOMMENDED CIRCUIT

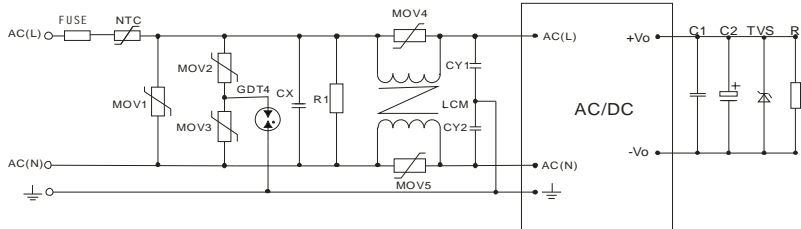

(Figure 3): Recommended circuit for applications which require higher EMC standard (external circuit output is the same as figure 1)

## EMC RECOMMENDED CIRCUIT PCB LAYOUT

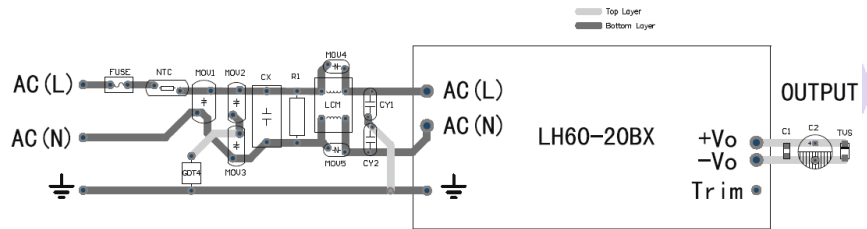

(figure 4): EMC application circuit PCB layout  
Safety and recommend wiring: linewidth  $\geq 3\text{mm}$ , line-line distance  $\geq 6\text{mm}$ , line-ground distance  $\geq 6\text{mm}$

### EXTERNAL CIRCUIT PARAMETERS

Model	C1( $\mu\text{F}$ )	C2( $\mu\text{F}$ )	TVS
LH60-20B05(-DT)	1	680	SMBJ7.0A
LH60-20B09(-DT)		470	SMBJ12A
LH60-20B12(-DT)		330	SMBJ20A
LH60-20B15(-DT)		330	SMBJ20A
LH60-20B24(-DT)		200	SMBJ30A
LH60-20B48(-DT)		100	SMBJ64A

Note:

- Output filtering capacitors C2 is electrolytic capacitors, It is recommended to use high frequency and low impedance electrolytic capacitors. For capacitance and current of capacitor please refer to manufacture's datasheet. Voltage derating of capacitor should be 80% or above. C1 is ceramic capacitor. it is used to filter high frequency noise. TVS is a recommended component to protect post-circuits (if converter fails).
- For standard EMC requirement, please refer to figure 1. If higher EMC requirement, please refer to figure 3, recommended parameters are shown in the table below.

Recommend Parameter For Higher EMC Standard Circuit	
Components	Recommend Parameter
MOV1	S20K350
MOV2	S14K350
MOV3	S14K350
MOV4	S10K350
MOV5	S10K350
CX	0.15 $\mu\text{F}$ /300VAC
CY1	2.2nF /400VAC
CY2	2.2nF /400VAC
R1	1M $\Omega$ /2W
LCM	2.2 mH, recommended to use MORNSUN's FL2D-30-222;
GDT4	B5G3600
NTC	5D-14
FUSE	3.15A/250V, slow blow, it must be connected to FUSE

# DIMENSIONS, RECOMMENDED FOOTPRINT & PACKAGING

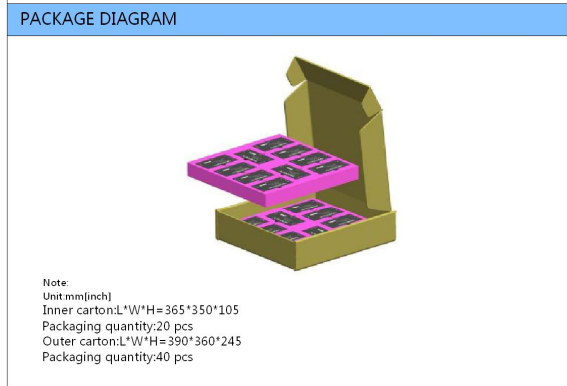
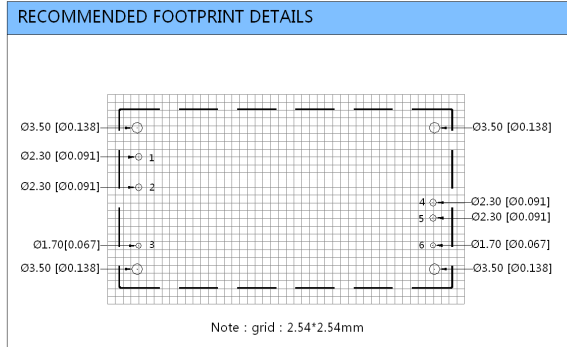
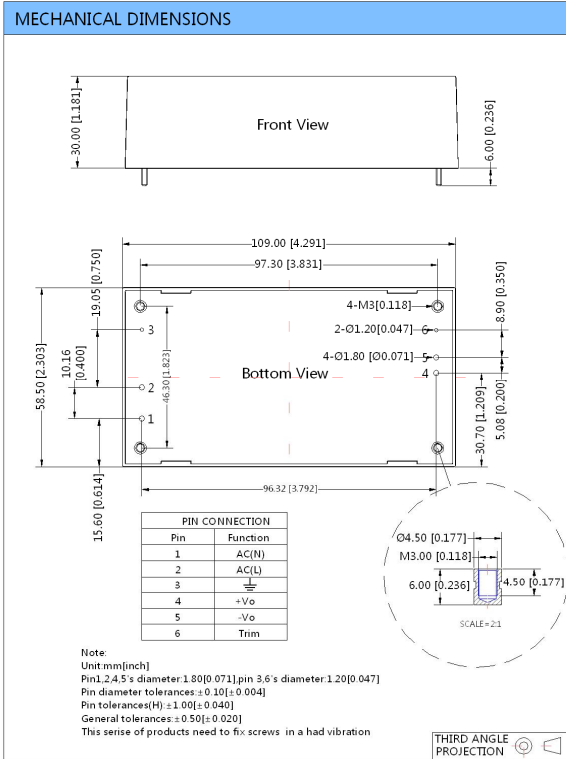

**MORNSUN Science & Technology Co.,Ltd.**

Address: No. 5, Kehui St. 1, Kehui development center, Science Ave., Guangzhou Science City, Luogang district, Guangzhou,P.R.China.

Tel: 86-20-38601850

Fax:86-20-38601272

E-mail: [info@mornsun.cn](mailto:info@mornsun.cn)

<http://www.mornsun-power.com>