

To our customers,

---

## Old Company Name in Catalogs and Other Documents

---

On April 1<sup>st</sup>, 2010, NEC Electronics Corporation merged with Renesas Technology Corporation, and Renesas Electronics Corporation took over all the business of both companies. Therefore, although the old company name remains in this document, it is a valid Renesas Electronics document. We appreciate your understanding.

Renesas Electronics website: <http://www.renesas.com>

April 1<sup>st</sup>, 2010  
Renesas Electronics Corporation

Issued by: Renesas Electronics Corporation (<http://www.renesas.com>)

Send any inquiries to <http://www.renesas.com/inquiry>.

## Notice

1. All information included in this document is current as of the date this document is issued. Such information, however, is subject to change without any prior notice. Before purchasing or using any Renesas Electronics products listed herein, please confirm the latest product information with a Renesas Electronics sales office. Also, please pay regular and careful attention to additional and different information to be disclosed by Renesas Electronics such as that disclosed through our website.
2. Renesas Electronics does not assume any liability for infringement of patents, copyrights, or other intellectual property rights of third parties by or arising from the use of Renesas Electronics products or technical information described in this document. No license, express, implied or otherwise, is granted hereby under any patents, copyrights or other intellectual property rights of Renesas Electronics or others.
3. You should not alter, modify, copy, or otherwise misappropriate any Renesas Electronics product, whether in whole or in part.
4. Descriptions of circuits, software and other related information in this document are provided only to illustrate the operation of semiconductor products and application examples. You are fully responsible for the incorporation of these circuits, software, and information in the design of your equipment. Renesas Electronics assumes no responsibility for any losses incurred by you or third parties arising from the use of these circuits, software, or information.
5. When exporting the products or technology described in this document, you should comply with the applicable export control laws and regulations and follow the procedures required by such laws and regulations. You should not use Renesas Electronics products or the technology described in this document for any purpose relating to military applications or use by the military, including but not limited to the development of weapons of mass destruction. Renesas Electronics products and technology may not be used for or incorporated into any products or systems whose manufacture, use, or sale is prohibited under any applicable domestic or foreign laws or regulations.
6. Renesas Electronics has used reasonable care in preparing the information included in this document, but Renesas Electronics does not warrant that such information is error free. Renesas Electronics assumes no liability whatsoever for any damages incurred by you resulting from errors in or omissions from the information included herein.
7. Renesas Electronics products are classified according to the following three quality grades: “Standard”, “High Quality”, and “Specific”. The recommended applications for each Renesas Electronics product depends on the product’s quality grade, as indicated below. You must check the quality grade of each Renesas Electronics product before using it in a particular application. You may not use any Renesas Electronics product for any application categorized as “Specific” without the prior written consent of Renesas Electronics. Further, you may not use any Renesas Electronics product for any application for which it is not intended without the prior written consent of Renesas Electronics. Renesas Electronics shall not be in any way liable for any damages or losses incurred by you or third parties arising from the use of any Renesas Electronics product for an application categorized as “Specific” or for which the product is not intended where you have failed to obtain the prior written consent of Renesas Electronics. The quality grade of each Renesas Electronics product is “Standard” unless otherwise expressly specified in a Renesas Electronics data sheets or data books, etc.
  - “Standard”: Computers; office equipment; communications equipment; test and measurement equipment; audio and visual equipment; home electronic appliances; machine tools; personal electronic equipment; and industrial robots.
  - “High Quality”: Transportation equipment (automobiles, trains, ships, etc.); traffic control systems; anti-disaster systems; anti-crime systems; safety equipment; and medical equipment not specifically designed for life support.
  - “Specific”: Aircraft; aerospace equipment; submersible repeaters; nuclear reactor control systems; medical equipment or systems for life support (e.g. artificial life support devices or systems), surgical implantations, or healthcare intervention (e.g. excision, etc.), and any other applications or purposes that pose a direct threat to human life.
8. You should use the Renesas Electronics products described in this document within the range specified by Renesas Electronics, especially with respect to the maximum rating, operating supply voltage range, movement power voltage range, heat radiation characteristics, installation and other product characteristics. Renesas Electronics shall have no liability for malfunctions or damages arising out of the use of Renesas Electronics products beyond such specified ranges.
9. Although Renesas Electronics endeavors to improve the quality and reliability of its products, semiconductor products have specific characteristics such as the occurrence of failure at a certain rate and malfunctions under certain use conditions. Further, Renesas Electronics products are not subject to radiation resistance design. Please be sure to implement safety measures to guard them against the possibility of physical injury, and injury or damage caused by fire in the event of the failure of a Renesas Electronics product, such as safety design for hardware and software including but not limited to redundancy, fire control and malfunction prevention, appropriate treatment for aging degradation or any other appropriate measures. Because the evaluation of microcomputer software alone is very difficult, please evaluate the safety of the final products or system manufactured by you.
10. Please contact a Renesas Electronics sales office for details as to environmental matters such as the environmental compatibility of each Renesas Electronics product. Please use Renesas Electronics products in compliance with all applicable laws and regulations that regulate the inclusion or use of controlled substances, including without limitation, the EU RoHS Directive. Renesas Electronics assumes no liability for damages or losses occurring as a result of your noncompliance with applicable laws and regulations.
11. This document may not be reproduced or duplicated, in any form, in whole or in part, without prior written consent of Renesas Electronics.
12. Please contact a Renesas Electronics sales office if you have any questions regarding the information contained in this document or Renesas Electronics products, or if you have any other inquiries.

(Note 1) “Renesas Electronics” as used in this document means Renesas Electronics Corporation and also includes its majority-owned subsidiaries.

(Note 2) “Renesas Electronics product(s)” means any product developed or manufactured by or for Renesas Electronics.

# MOS INTEGRATED CIRCUIT

# $\mu$ PD178016GC-051

## 8-BIT SINGLE-CHIP MICROCONTROLLER WITH BUILT-IN PRESCALER, PLL FREQUENCY SYNTHESIZER, AND IF COUNTER FOR AUTOMOTIVE FM/MW/LW RADIO APPLICATIONS

The  $\mu$ PD178016GC-051 is an 8-bit CMOS microcontroller for use in digital tuners designed to receive the European FM, MW, and LW bands. It incorporates a prescaler, PLL frequency synthesizer, and IF counter.

The device supports European RDS (Radio Data System), and offers many RDS functions. Thus, it enables the configuration of a high-performance, multi-function FM/MW/LW tuner, such as an automotive stereo system, using a single chip.

Because the device implements the RDS decoder as a software library, an RDS system can be configured by combining the device with an RDS data demodulation IC  $\mu$ PC2539.

### FEATURES

- Preset memory
  - Stores six stations in each of the FM1, FM2, FM3, and AM bands (the AM band is shared between the MW and LW bands), giving a total of 24 stations
- Last channel memory
  - One station per band, totaling four stations
- Tuning functions
  - Manual seek/auto-seek
  - Auto-storage
  - Preset scan
  - Auto-retuning
- A  $\mu$ PD16431A is used as the LCD controller/driver
- Single power supply ( $V_{DD} = 5\text{ V} \pm 10\%$ )
- RDS functions
  - Built-in RDS decoder function
  - Station name display (PS)
  - AF function
  - Traffic information standby function (TP and TA)
  - EON function
  - CT function (automatic time adjustment)
  - Alarm function (PTY = 31)
  - PTY seek function (program identification information)
- CD changer and logic tape deck control
- Electronic volume control
- Remote-controller signal reception function (a  $\mu$ PD6121G-002 is used for sending the remote-controller signal)

### ORDERING INFORMATION

Part number	Package
$\mu$ PD178016GC-051-3B9	80-pin plastic QFP (14 × 14 mm), 0.65-mm pitch

The information in this document is subject to change without notice.

**FUNCTION OVERVIEW**

**Tunable Frequencies, Channel Separation, Reference Frequency, and Intermediate Frequency**

Region	Band	Tunable frequency	Channel separation	Reference frequency	Intermediate frequency
Europe	FM	87.50 to 108.0 MHz	50 kHz	50 kHz	10.7 MHz
	MW	522 to 1 620 kHz	9 kHz	9 kHz	450 kHz/459 kHz/10.71 MHz
	LW	144 to 288 kHz	9 kHz	9 kHz	450 kHz/459 kHz/10.71 MHz
USA	FM	87.50 to 108.0 MHz	50 kHz	50 kHz	10.7 MHz
	MW	530 to 1 720 kHz	10 kHz	10 kHz	450 kHz

**TUNING FUNCTIONS**

**(1) Manual tuning**

Function	Description
Manual up Manual down	Each time one of these keys is pressed, the frequency is increased or reduced by one step, respectively. If either of the keys is held down, the frequency is increased or reduced in high-speed mode until the key is released.

**(2) Auto tuning**

Function	Description
Seek up Seek down	Search for a station, moving either up or down through the frequency range, respectively. When a station is detected, the corresponding frequency is retained.

**(3) Preset memory**

Stores six stations in each band (FM1/FM2/FM3/AM), giving a total of 24 stations.

**(4) Preset memory scanning**

Tunes to the stations stored in the preset memory, holding each station for about five seconds, in each of the FM1, FM2, FM3, and AM bands.

**(5) Auto-storage**

Searches through the entire frequency range of the received bands and stores the frequencies of the detected stations in the preset memory.

**(6) Last channel memory**

Stores the frequency of the most-recently received station in each of the FM1, FM2, FM3, and AM bands, totaling four stations.

**(7) Auto-retuning**

Automatically starts auto-tuning if the SD signal is not detected for about 30 seconds during broadcast reception. Also starts seek up if traffic information is not received for four seconds in TP/SK mode.

## RDS FUNCTIONS

### (1) Station name display

Uses a PS code to display the name of the station currently being received.

### (2) AF function

If reception of the received RDS station deteriorates, searches for and tunes to an RDS station having the same broadcast contents.

Supports METHOD A and METHOD B, and stores an AF list of up to 40 stations. Using EON, the device can also store an AF list of other stations.

### (3) Traffic information station switching

Selects radio mode when traffic information broadcasting starts.

Switches to a traffic information station by monitoring the TP and TA bits during TP/SK standby. This function supports EON.

### (4) Time correction

Uses a CT code to correct the built-in clock.

### (5) RDS station seek

- RDS seek  
Searches for RDS stations only.
- PTY seek  
Searches for an RDS station broadcasting a specific type of program.
- TP/SK seek  
Searches for an RDS station broadcasting traffic information.
- TP auto-storage  
Writes only an RDS station broadcasting traffic information to the preset memory.

### (6) Program identification information

Displays the name of the program currently being received by using a PTY code.

The device is also capable of performing search based on the displayed program name.

## TAPE FUNCTIONS

- (1) FF/REW: Fast-forwards or rewinds the tape.
- (2) TAPE: Switches the tape side between A and B.
- (3) AMS: Searches for the beginning of a track.

## CD CHANGER CONTROL FUNCTIONS

- (1) **Disc selection**  
Selects a specified CD.
- (2) **Track up/down**  
Moves up or down by one track.
- (3) **Search up/down**  
Fast-forward and rewind.
- (4) **REPEAT**  
Repeats the playback of a track.
- (5) **DISC REPEAT**  
Repeats the playback of an entire disc.
- (6) **RANDOM**  
Selects and plays back the tracks of a single CD at random.
- (7) **DISK RANDOM**  
Selects and plays back the tracks of all the CDs at random.
- (8) **INTRO**  
Sequentially plays back the first ten seconds of each track, starting from the first track.
- (9) **DISK INTRO**  
Sequentially plays back the first ten seconds of the first track of each CD.

## CLOCK FUNCTIONS

- (1) 12-hour clock display (with “AM” and “PM” indication) or 24-hour clock display
- (2) Selectable colon (“:”) flashing (1 Hz)
- (3) Back up (with low power consumption) in no-clock mode

## ELECTRONIC VOLUME CONTROL FUNCTIONS

- (1) The volume/bass/treble/balance/fader are adjustable.
- (2) The loudness function is settable.

**PIN CONFIGURATION (TOP VIEW)**

80-pin plastic QFP (14 × 14 mm, 0.65-mm pitch)

μPD178016GC-051-3B9

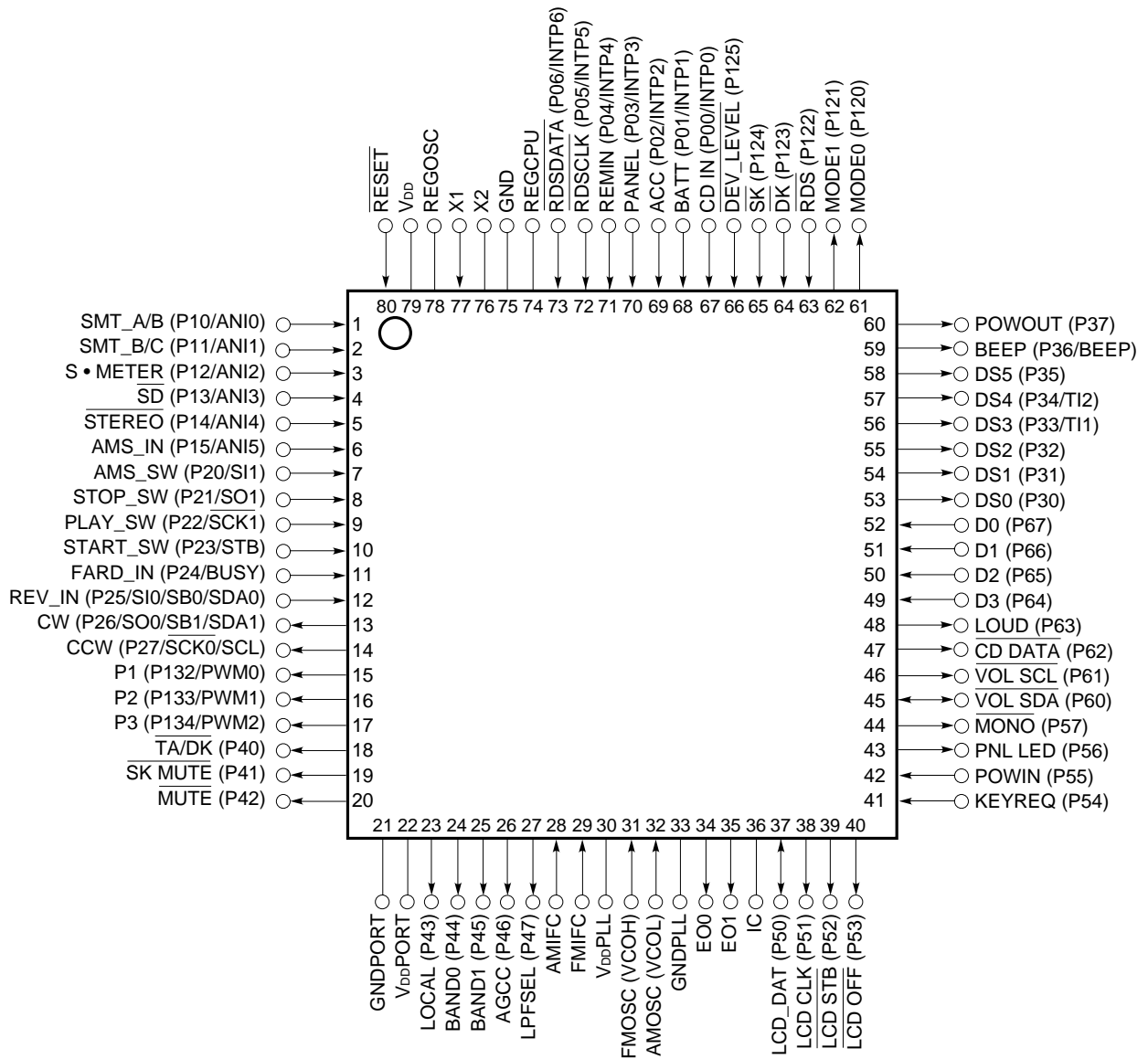

- Remarks 1.** ( ): μPD178016GC-xxx-3B9  
**2.** IC: Internally connected

CONTENTS

**1. PIN FUNCTIONS ..... 8**

**2. KEY MATRIX STRUCTURE ..... 16**

2.1 Configuration of Initial Setting Diode Matrix and Transistor Switch ..... 16

2.2 Connection between Initial Setting Diode Matrix and Transistor Switch ..... 16

2.3 Momentary Key Matrix Configuration ..... 17

2.4 Momentary Key Matrix Connection ..... 18

2.5 Description of the Key Matrixes ..... 19

2.5.1 Initial setting diode matrix ..... 19

2.5.2 Transistor switch ..... 24

2.5.3 Momentary keys ..... 25

**3. RDS (RADIO DATA SYSTEM) FUNCTIONS ..... 37**

3.1 Processing RDS Data ..... 37

3.1.1 PI (Program Identification) ..... 37

3.1.2 PS (Program Service Name) ..... 37

3.1.3 PTY (Program Type) ..... 37

3.1.4 RDS memory ..... 38

3.1.5 AF (Alternative Frequency) ..... 39

3.1.6 Best station ..... 46

3.1.7 Automatic station selection ..... 47

3.1.8 Emergency broadcasting reception ..... 48

3.1.9 EON (Enhanced Other Network) ..... 49

3.1.10 TP (Traffic Program Identification), TA (Traffic Announcement Identification) ..... 49

3.1.11 CT (Clock Time and Data) ..... 50

**4. SELECTOR CONTROL ..... 51**

4.1 Timing of Transition from POWER ON to OFF, and Vice Versa, with the **POWER** Key ..... 51

4.2 Timing of Transition from POWER ON to OFF, Vice Versa, with the Detachable Panel ..... 52

4.3 Timing of Audio Mode Switching ..... 53

4.4 Timing of Audio Mode Switching while Traffic Information Is Being Broadcast (in TP/SK Mode) ..... 54

4.5 Detection of Front Panel Detachment ..... 55

4.6 Timing of Audio Mode Switching Timing with PTY Alarm (PTY = 31) ..... 56

**5. LCD PANEL ..... 57**

5.1 Configuration of the LCD Panel ..... 57

5.2 Assignment of LCD Pins ..... 57

5.3 LCD Panel Displays ..... 60

**6. DESCRIPTION OF μPD16431A CONTROL ..... 65**

6.1 Key Scan ..... 65

6.2 Initial Data Output ..... 66

6.3 Display Data Output ..... 66

6.4 Key Data Input/Output ..... 67



**7. REMOTE CONTROL ..... 68**

7.1 Remote Control Key Configuration (When the μPD6121G Is Used) ..... 68

7.2 Description of the Remote Control Keys ..... 69

7.3 Remote Control Data Codes ..... 69

7.4 Sample Remote Control Circuit Using the μPD6121G-002 ..... 70

7.5 Sample Remote Control Preamplifier Using the μPC2800HA ..... 70

**8. DESCRIPTION OF CD CHANGER CONTROL ..... 71**

**9. ELECTRONIC VOLUME CONTROLS ..... 72**

9.1 Electronic Volume Controls ..... 72

9.2 Initial Values of Electronic Volume Controls ..... 72

**10. MUTE OUTPUT TIMING CHART ..... 73**

10.1 Manual Up/Down ..... 74

10.1.1 1-channel up/down ..... 74

10.1.2 Successive up/down ..... 74

10.2 Auto Up/Down ..... 75

10.2.1 Normal seek ..... 75

10.2.2 RDS seek ..... 75

10.2.3 PI seek ..... 75

10.2.4 TP seek ..... 76

10.2.5 PTY seek ..... 76

10.3 Preset Memory Calling ..... 77

10.4 Preset Memory Scan ..... 77

10.5 Auto-Storage ..... 78

10.5.1 Auto-storage ..... 78

10.5.2 TP auto-storage ..... 78

10.6 POWER On/Off ..... 79

10.6.1 Power on ..... 79

10.6.2 Power off ..... 80

10.7 Mode Switching ..... 80

**11. SAMPLE APPLICATION CIRCUIT ..... 81**

**12. ELECTRICAL CHARACTERISTICS (PRELIMINARY) ..... 82**

**13. PACKAGE DRAWING ..... 88**

**14. RECOMMENDED SOLDERING CONDITIONS ..... 89**

1. PIN FUNCTIONS

Pin No.	Symbol	Pin name	Description	I/O type						
1 2	SMT_A/B SMT_B/C	Signal meter reading range input	Pins used for setting the signal meter voltage ranges used to determine the condition for starting an AF operation. Input analog voltages according to the characteristics of the tuner being used (See <b>(1)</b> in <b>Section 3.1.5</b> ).	Analog input						
3	S • METER	Signal meter signal input	Input pin for signal meter signal. Input an analog signal in accordance with the received signal strength. This pin is used to monitor the conditions controlling AF switching.	Analog input						
4	$\overline{\text{SD}}$	SD signal input	Input pin for the station detection signal. Input the signal as indicated in the table below. <table border="1" style="margin: 10px auto;"> <thead> <tr> <th><math>\overline{\text{SD}}</math> pin</th> <th>Description</th> </tr> </thead> <tbody> <tr> <td>0</td> <td>Station detected</td> </tr> <tr> <td>1</td> <td>Station not detected</td> </tr> </tbody> </table> (0: Low, 1: High)	$\overline{\text{SD}}$ pin	Description	0	Station detected	1	Station not detected	Input
$\overline{\text{SD}}$ pin	Description									
0	Station detected									
1	Station not detected									
5	$\overline{\text{STEREO}}$	Stereo signal input	Input pin for the stereo broadcast signal. This pin is valid for the FM band only. Input the signal as indicated in the table below. <table border="1" style="margin: 10px auto;"> <thead> <tr> <th><math>\overline{\text{STEREO}}</math> pin</th> <th>Description</th> </tr> </thead> <tbody> <tr> <td>0</td> <td>Stereo broadcast</td> </tr> <tr> <td>1</td> <td>Mono broadcast</td> </tr> </tbody> </table> (0: Low, 1: High)	$\overline{\text{STEREO}}$ pin	Description	0	Stereo broadcast	1	Mono broadcast	Input
$\overline{\text{STEREO}}$ pin	Description									
0	Stereo broadcast									
1	Mono broadcast									
6	AMS_IN	Audio signal input	Pin indicating input of the audio signal from the logic tape deck. Input the signal as indicated in the table below. <table border="1" style="margin: 10px auto;"> <thead> <tr> <th>AMS_IN pin</th> <th>Description</th> </tr> </thead> <tbody> <tr> <td>0</td> <td>Audio signal not input</td> </tr> <tr> <td>1</td> <td>Audio signal input</td> </tr> </tbody> </table> (0: Low, 1: High)	AMS_IN pin	Description	0	Audio signal not input	1	Audio signal input	Input
AMS_IN pin	Description									
0	Audio signal not input									
1	Audio signal input									
7	AMS_SW	AMS switch signal input	Input pin for logic tape deck state. Input the signal as indicated in the table below. <table border="1" style="margin: 10px auto;"> <thead> <tr> <th>AMS_SW pin</th> <th>Description</th> </tr> </thead> <tbody> <tr> <td>0</td> <td>AMS mode</td> </tr> <tr> <td>1</td> <td>Other than AMS mode</td> </tr> </tbody> </table> (0: Low, 1: High)	AMS_SW pin	Description	0	AMS mode	1	Other than AMS mode	Input
AMS_SW pin	Description									
0	AMS mode									
1	Other than AMS mode									
8	STOP_SW	STOP switch signal input	Input pin of logic tape deck state. Input the signal as indicated in the table below. <table border="1" style="margin: 10px auto;"> <thead> <tr> <th>STOP_SW pin</th> <th>Description</th> </tr> </thead> <tbody> <tr> <td>0</td> <td>FF/REW</td> </tr> <tr> <td>1</td> <td>PLAY</td> </tr> </tbody> </table> (0: Low, 1: High)	STOP_SW pin	Description	0	FF/REW	1	PLAY	Input
STOP_SW pin	Description									
0	FF/REW									
1	PLAY									

Pin No.	Symbol	Pin name	Description	I/O type																								
9	PLAY_SW	PLAY switch signal input	<p>Input pin for logic tape deck state. Input the signal as indicated in the table below.</p> <table border="1"> <thead> <tr> <th>PLAY_SW pin</th> <th>Description</th> </tr> </thead> <tbody> <tr> <td>0</td> <td>PLAY</td> </tr> <tr> <td>1</td> <td>FF/REW</td> </tr> </tbody> </table> <p>(0: Low, 1: High)</p>	PLAY_SW pin	Description	0	PLAY	1	FF/REW	Input																		
PLAY_SW pin	Description																											
0	PLAY																											
1	FF/REW																											
10	START_SW	START switch signal input	<p>Input pin for logic tape deck state. Input the signal as indicated in the table below.</p> <table border="1"> <thead> <tr> <th>START_SW pin</th> <th>Description</th> </tr> </thead> <tbody> <tr> <td>0</td> <td>EJECT</td> </tr> <tr> <td>1</td> <td>LOADING-EJECT</td> </tr> </tbody> </table> <p>(0: Low, 1: High)</p>	START_SW pin	Description	0	EJECT	1	LOADING-EJECT	Input																		
START_SW pin	Description																											
0	EJECT																											
1	LOADING-EJECT																											
11	FARD_IN	Side A pulse signal input	Input pin for pulse of side A of logic tape deck.	Input																								
12	REV_IN	Side B pulse signal input	Input pin for pulse of side B of logic tape deck.	Input																								
13 14	CW CCW	Power motor control signal output	<p>Output pins controlling the power motor of the logic tape deck. The signals are output as indicated in the table below.</p> <table border="1"> <thead> <tr> <th>CW pin</th> <th>CCW pin</th> <th>Description</th> </tr> </thead> <tbody> <tr> <td>0</td> <td>1</td> <td>LOADING</td> </tr> <tr> <td>1</td> <td>0</td> <td>EJECT</td> </tr> <tr> <td>0</td> <td>0</td> <td>STOP</td> </tr> <tr> <td>1</td> <td>1</td> <td>BRAKE</td> </tr> </tbody> </table> <p>(0: Low, 1: High)</p>	CW pin	CCW pin	Description	0	1	LOADING	1	0	EJECT	0	0	STOP	1	1	BRAKE	CMOS push-pull output									
CW pin	CCW pin	Description																										
0	1	LOADING																										
1	0	EJECT																										
0	0	STOP																										
1	1	BRAKE																										
15 to 17	P1 to P3	Main motor control signal output	<p>Output pins controlling the main motor of the logic tape deck. The signals are output as indicated in the table below.</p> <table border="1"> <thead> <tr> <th>P1 pin</th> <th>P2 pin</th> <th>P3 pin</th> <th>Description</th> </tr> </thead> <tbody> <tr> <td>1</td> <td>0</td> <td>0</td> <td>PLAY, side A</td> </tr> <tr> <td>0</td> <td>1</td> <td>0</td> <td>PLAY, side B</td> </tr> <tr> <td>1</td> <td>0</td> <td>1</td> <td>FF, side A</td> </tr> <tr> <td>0</td> <td>1</td> <td>1</td> <td>FF, side B</td> </tr> <tr> <td>0</td> <td>0</td> <td>0</td> <td>STOP</td> </tr> </tbody> </table> <p>(0: Low, 1: High)</p>	P1 pin	P2 pin	P3 pin	Description	1	0	0	PLAY, side A	0	1	0	PLAY, side B	1	0	1	FF, side A	0	1	1	FF, side B	0	0	0	STOP	N-ch open-drain output
P1 pin	P2 pin	P3 pin	Description																									
1	0	0	PLAY, side A																									
0	1	0	PLAY, side B																									
1	0	1	FF, side A																									
0	1	1	FF, side B																									
0	0	0	STOP																									
18	$\overline{\text{TA/DK}}$	Traffic information station signal output	<p>Traffic information station identification signal output pin. The output of this pin is low when:</p> <ul style="list-style-type: none"> <li>The SK and DK signals, TP and TA signals, or PTY alarm is detected in TP/SK mode in the FM band, or</li> <li>A traffic information alarm is output.</li> </ul>	CMOS push-pull output																								
19	$\overline{\text{SK MUTE}}$	SK mute signal output	<p>Traffic information mute output pin. The SK mute output pin is used when a traffic information station identification signal is not being received in TP/SK mode.</p>	CMOS push-pull output																								

Pin No.	Symbol	Pin name	Description	I/O type												
20	MUTE	Mute signal output	Audio mute signal output pin. The output of this pin is active low. This pin is used to eliminate the shock noise generated when the PLL is out of lock in radio mode, and to switch the mode pin output.	CMOS push-pull output												
21	GNDPORT	Ground pin for port	Ground pin for port. Connect this pin to GND.	—												
22	V <sub>DD</sub> PORT	Positive power supply pin for port	Positive power supply pin for port. Connect this pin to V <sub>DD</sub> .	—												
23	LOCAL	Local signal output	Output pin for the tuner LOCAL/DX switching output. The output of this pin is high while the device is in LOCAL mode.	CMOS push-pull output												
24 25	BAND0 BAND1	Band switching signal output	Band switching signal output pins. These pins output the following signals in each band. <table border="1" style="margin-left: auto; margin-right: auto;"> <thead> <tr> <th>Band</th> <th>BAND0 pin</th> <th>BAND1 pin</th> </tr> </thead> <tbody> <tr> <td>MW</td> <td>0</td> <td>0</td> </tr> <tr> <td>LW</td> <td>0</td> <td>1</td> </tr> <tr> <td>FM</td> <td>1</td> <td>0</td> </tr> </tbody> </table> <p style="text-align: right;">(0: Low, 1: High)</p> The FM band is output when power is first applied.	Band	BAND0 pin	BAND1 pin	MW	0	0	LW	0	1	FM	1	0	CMOS push-pull output
Band	BAND0 pin	BAND1 pin														
MW	0	0														
LW	0	1														
FM	1	0														
26	AGCC	AGCC signal output	Output pin for the auto gain control cut signal. The signal is output during auto-tuning.	CMOS push-pull output												
27	LPFSEL	LPF time constant switching signal output	Output pin for the signal for switching the time constant of the LPF of the tuner during AF operation. The output level of this pin goes high during AF operation.	CMOS push-pull output												
28	AMIFC	AM intermediate frequency input	Input pin for intermediate frequency (IF) in the AM (MW, LW) band. To protect the built-in AC amplifier, use a capacitor to prevent the flow of direct current. When the AM SD/IF switch of the initial setting diode matrix is set to 1 (the diode is jumpered), this pin is used to detect a station during auto-tuning. When the input frequency range and the conditions listed below are satisfied, the device judges that a station has been detected. <table border="1" style="margin-left: auto; margin-right: auto;"> <thead> <tr> <th>Band</th> <th>Input frequency range</th> </tr> </thead> <tbody> <tr> <td rowspan="2">MW</td> <td>450 kHz ± 3 kHz</td> </tr> <tr> <td>459 kHz ± 3 kHz</td> </tr> <tr> <td rowspan="2">LW</td> <td>450 kHz ± 3 kHz</td> </tr> <tr> <td>459 kHz ± 3 kHz</td> </tr> </tbody> </table> A frequency within the input frequency range must be input within 20 ms of the PLL being locked.	Band	Input frequency range	MW	450 kHz ± 3 kHz	459 kHz ± 3 kHz	LW	450 kHz ± 3 kHz	459 kHz ± 3 kHz	Input				
Band	Input frequency range															
MW	450 kHz ± 3 kHz															
	459 kHz ± 3 kHz															
LW	450 kHz ± 3 kHz															
	459 kHz ± 3 kHz															

Pin No.	Symbol	Pin name	Description	I/O type				
29	FMIFC	FM intermediate frequency input	<p>Input pin for intermediate frequency (IF) in FM band.</p> <p>To protect the built-in AC amplifier, use a capacitor to prevent the flow of direct current.</p> <p>When the FM SD/IF switch of the initial setting diode matrix is set to 1 (the diode is jumpered), this pin is used to detect a station during auto-tuning.</p> <p>When the input frequency range and conditions listed below are satisfied, the device judges that a station has been detected.</p> <table border="1" style="margin-left: auto; margin-right: auto;"> <thead> <tr> <th>Band</th> <th>Input frequency range</th> </tr> </thead> <tbody> <tr> <td>FM</td> <td>10.7 MHz ± 25.0 kHz</td> </tr> </tbody> </table> <p>A frequency within the input frequency range must be input within 20 ms of the PLL being locked. However, input the frequency within 5 ms during AF operation, best station, or EON operation.</p>	Band	Input frequency range	FM	10.7 MHz ± 25.0 kHz	Input
Band	Input frequency range							
FM	10.7 MHz ± 25.0 kHz							
30	V <sub>DD</sub> PLL	Positive power supply pin for PLL	<p>Positive power supply pin for PLL.</p> <p>Connect this pin to V<sub>DD</sub>.</p>	—				
31	FMOSC	FM local oscillator input	<p>Input pin for the FM band local oscillator output (VCO output).</p> <p>Tuning to FM band broadcasts causes this pin to become active. Otherwise, the pin enters the high-impedance state.</p> <p>To protect the built-in AC amplifier, use a capacitor to prevent the flow of direct current before inputting the output.</p>	Input				
32	AMOSC	AM local oscillator input	<p>Input pin for the local oscillator output (VCO output) in the AM (MW, LW) band.</p> <p>Tuning to MW or LW band broadcasts causes this pin to become active. Otherwise, the pin enters the high-impedance state.</p> <p>To protect the built-in AC amplifier, use a capacitor to prevent the flow of direct current before inputting the output.</p>	Input				
33	GNDPLL	PLL ground pin	<p>Ground pin for PLL.</p> <p>Connect this pin to GND.</p> <p>Insert a 100-pF capacitor between the V<sub>DD</sub>PLL pin and GNDPLL pin.</p>	—				
34 35	EO0 EO1	Error output	<p>Output pins for the PLL charge pump.</p> <p>If a divided local oscillator frequency (VCO output) is greater than the reference frequency, the outputs of these pins will go high. If the divided local oscillator frequency is less than the reference frequency, the outputs go low. If the divided local oscillator frequency is equal to the reference frequency, the outputs enter the floating state.</p> <p>Input either of the outputs to a varactor diode via an external LPF (Low Pass Filter).</p>	CMOS 3-state output				
36	IC	Internally connected	Connect this pin to GND.	—				
37	LCD_DAT	LCD driver data signal input/output	Input/output pin for exchanging serial data with the LCD controller/driver (μPD16431A).	Input CMOS push-pull output				

Pin No.	Symbol	Pin name	Description	I/O type						
38	LCD CLK	LCD driver clock output	Output pin for sending the serial clock to the LCD controller/driver (μPD16431A). Reads data at a rising edge and outputs data at a falling edge. The serial interface with the LCD controller/driver is of 2-wire serial type.	CMOS push-pull output						
39	LCD STB	LCD driver strobe signal output	Output pin for the strobe signal to the LCD controller/driver (μPD16431A). Outputs data while low. Processes data at a rising edge.	CMOS push-pull output						
40	LCD OFF	LCD driver display OFF signal output	Output pin for sending the display OFF signal to the LCD controller/driver (μPD16431A).	CMOS push-pull output						
41	KEYREQ	LCD driver key request signal input	Input pin for the key request signal, output by the LCD controller/driver (μPD16431A). When a high level signal is input, key data is read.	Input						
42	POWIN	Power key signal input	Signal input pin used to detect power key input.	Input						
43	PNL LED	Panel detachment detection LED signal output	Output pin for the LED signal indicating that the front panel has been detached. In this state, the pin outputs a 1-Hz signal. The active level is high.	CMOS push-pull output						
44	MONO	MONO signal output	Control signal output pin of forced MONO. The signal is output as follows: <table border="1" style="margin-left: auto; margin-right: auto;"> <thead> <tr> <th>MONO pin</th> <th>Description</th> </tr> </thead> <tbody> <tr> <td>0</td> <td>Forced MONO ON</td> </tr> <tr> <td>1</td> <td>Forced MONO OFF</td> </tr> </tbody> </table> <p style="text-align: right;">(0: Low, 1: High)</p> This pin outputs a high level when the power is first applied.	MONO pin	Description	0	Forced MONO ON	1	Forced MONO OFF	CMOS push-pull output
MONO pin	Description									
0	Forced MONO ON									
1	Forced MONO OFF									
45	VOL SDA	Electronic volume control data input/output	Input/output pin for the serial data that is fed to the electronic volume control (TDA7313, TEA6320).	Input N-ch open-drain output						
46	VOL SCL	Electronic volume control clock output	Output pin for the serial clock that is fed to the electronic volume control (TDA7313, TEA6320). Data is read at a rising edge and data is output at a falling edge. The interface with the electronic volume control is of I <sup>2</sup> C bus type.	N-ch open-drain output						
47	CD DATA	CD changer data output	Output pin for the data to the CD changer.	N-ch open-drain output						
48	LOUD	Loudness signal output	Output pin for the loudness control signal. The signal is output as indicated in the table below. <table border="1" style="margin-left: auto; margin-right: auto;"> <thead> <tr> <th>LOUD pin</th> <th>Description</th> </tr> </thead> <tbody> <tr> <td>0</td> <td>Loudness OFF</td> </tr> <tr> <td>1</td> <td>Loudness ON</td> </tr> </tbody> </table> <p style="text-align: right;">(0: Low, 1: High)</p> This pin outputs a low level when the power is first applied.	LOUD pin	Description	0	Loudness OFF	1	Loudness ON	N-ch open-drain output
LOUD pin	Description									
0	Loudness OFF									
1	Loudness ON									

Pin No.	Symbol	Pin name	Description	I/O type												
49 to 52	D3 to D0	Initial setting diode return signal input	Input pins for the return signals of the initial setting diode matrix. These pins, together with DS0 (pin 53) to DS5 (pin 58), constitute a diode matrix. Connect a pull-down resistor to these pins.	Input												
53 to 58	DS0 to DS5	Initial setting diode source signal output	Output pins for the source signals of the initial setting diode matrix. These pins, together with D3 (pin 49) to D0 (pin 52), constitute a diode matrix.	CMOS push-pull output												
59	BEEP	Beep signal output	Beep output pin. A square wave with a frequency of 1.5 kHz and a duty cycle of 50 % is output for 50 ms. A beep is output when: <ul style="list-style-type: none"> <li>• The beep is validated by pressing a key.</li> <li>• The next preset memory is selected during preset memory scan operation.</li> </ul>	CMOS push-pull output												
60	POWOUT	Power state output	Output pin indicating the power state of the system.	CMOS push-pull output												
61 62	MODE0 MODE1	Mode signal output	Output pins indicating the operating mode. See the table below. <table border="1" style="margin-left: auto; margin-right: auto;"> <thead> <tr> <th>MODE0</th> <th>MODE1</th> <th>Mode</th> </tr> </thead> <tbody> <tr> <td>0</td> <td>0</td> <td>Radio</td> </tr> <tr> <td>1</td> <td>0</td> <td>Tape</td> </tr> <tr> <td>1</td> <td>1</td> <td>CD</td> </tr> </tbody> </table> <p style="text-align: right;">(0: Low, 1: High)</p> Radio output mode is set when the power is first applied.	MODE0	MODE1	Mode	0	0	Radio	1	0	Tape	1	1	CD	CMOS push-pull output
MODE0	MODE1	Mode														
0	0	Radio														
1	0	Tape														
1	1	CD														
63	$\overline{\text{RDS}}$	RDS indicator signal input	Input pin used to detect the RDS signal of an RDS station. Prevents the device from erroneously locking onto a non-RDS station. The RDS data, read when the pin is at the low level, is valid. <u>Pull down this pin if synchronization is to be performed using only RDSDATA and RDSCLK during auto-tuning.</u>	Input												
64	$\overline{\text{DK}}$	DK signal input	Input pin <u>used</u> to <u>detect</u> the DK signal of a VF station. If both the SK and DK pins go low in standby mode, the device judges that traffic information is being broadcast and the device switches to <u>standby</u> radio mode. If the level of the DK pin goes from low to high, the device returns to standby mode. <u>Pull up this pin when ARI is not to be used.</u>	Input												
65	$\overline{\text{SK}}$	SK signal input	Input pin used to detect the SK signal of a VF station. The input is used as the auto-tuning stop signal. When a station is detected, if the input goes low within about 500 ms, the device judges that a traffic information station has been detected, and auto-tuning is stopped. <u>Pull up this pin when ARI is not used.</u>	Input												

Pin No.	Symbol	Pin name	Description	I/O type						
66	DEV_LEVEL	Modulation signal input	<p>Input pin for the modulation signal. Input the signal as indicated in the table below.</p> <table border="1"> <thead> <tr> <th>DEV_LEVEL pin</th> <th>Description</th> </tr> </thead> <tbody> <tr> <td>0</td> <td>Mute</td> </tr> <tr> <td>1</td> <td>Sound</td> </tr> </tbody> </table> <p>(0: Low, 1: High)</p>	DEV_LEVEL pin	Description	0	Mute	1	Sound	Input
DEV_LEVEL pin	Description									
0	Mute									
1	Sound									
67	CD IN	CD changer data input	Input pin for the CD changer data.	Input						
68	BATT	BATT signal input	<p>Input pin for the BATT signal. Input the signal as indicated in the table below.</p> <table border="1"> <thead> <tr> <th>BATT pin</th> <th>Description</th> </tr> </thead> <tbody> <tr> <td>0</td> <td>Power OFF</td> </tr> <tr> <td>1</td> <td>Power ON</td> </tr> </tbody> </table> <p>(0: Low, 1: High)</p> <p>In no-clock mode (initial setting diode NOCLK = 1) or a mode in which the clock is not counted during power off (initial setting diode CTOFF = 1), the power consumption is reduced during power off.</p>	BATT pin	Description	0	Power OFF	1	Power ON	Input
BATT pin	Description									
0	Power OFF									
1	Power ON									
69	ACC	ACC signal input	<p>Input pin for the ACC signal. Input the signal as indicated in the table below.</p> <table border="1"> <thead> <tr> <th>ACC pin</th> <th>Description</th> </tr> </thead> <tbody> <tr> <td>0</td> <td>Power OFF</td> </tr> <tr> <td>1</td> <td>Power ON</td> </tr> </tbody> </table> <p>(0: Low, 1: High)</p> <p>In no-clock mode (initial setting diode NOCLK = 1) or a mode in which the clock is not counted during power off (initial setting diode CTOFF = 1), the power consumption is reduced during power off.</p>	ACC pin	Description	0	Power OFF	1	Power ON	Input
ACC pin	Description									
0	Power OFF									
1	Power ON									
70	PANEL	Panel detachment detection input	Input pin used to detect whether the front panel has been detached. The input of a high-level signal indicates that the front panel has been detached.	Input						
71	REMIN	Remote-controller signal input	Remote-controller signal input pin.	Input						
72	RDSCLK	RDS clock input	<p>RDS clock input pin. To this pin, input the clock signal from the RDS signal detector section.</p> <p>Because the μPD178016GC-051 does not detect bit synchronization based on the width of a clock signal, the input clock signal must be as accurate as possible.</p>	Input						
73	RDSDATA	RDS data input	Input pin for RDS data. To this pin, input the data signal from the RDS signal detector section. Data is read at the falling edge of an RDS clock pulse.	Input						
74	REGCPU	CPU power supply regulator	Regulator pin for CPU power supply. Connect this pin to ground via a 0.1-μF capacitor.	—						
75	GND	Ground	Device ground	—						



Pin No.	Symbol	Pin name	Description	I/O type
76	X2	Crystal resonator	Pin for connecting a 4.5-MHz crystal resonator.	—
77	X1			
78	REGOSC	Oscillation circuit regulator	Regulator pin for oscillation circuit. Connect this pin to ground via a 0.1-μF capacitor.	—
79	V <sub>DD</sub>	Power supply	Power supply pins for the device. To this pin, supply 5 V ± 10 % while the device is operating.	—
80	RESET	Reset input	Reset input pin.	Input

## 2. KEY MATRIX STRUCTURE

### 2.1 Configuration of Initial Setting Diode Matrix and Transistor Switch

Input pin \ Output pin	D0 (52)	D1 (51)	D2 (50)	D3 (49)
DS0 (53)	AM SD/IF	FM SD/IF	AMIF1	AMIF2
DS1 (54)	NOCLK	CTADJ	CTOFF	FLASH
DS2 (55)	RETUNE	NO_PIM	BEEP	DEV_SEL
DS3 (56)	CLK24	REGION	VOLSEL	FAD
DS4 (57)	ERR_COR3	ERR_COR2	ERR_COR1	AFALL
DS5 (58)	POWER1	POWER2	AMERICA	METAL

Remarks 1. Numbers in ( ) are pin numbers.

2. : Initial setting diode, : Transistor switch

### 2.2 Connection between Initial Setting Diode Matrix and Transistor Switch

Initial setting diode

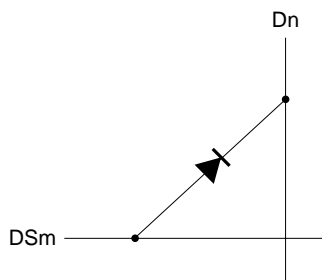

Transistor switch

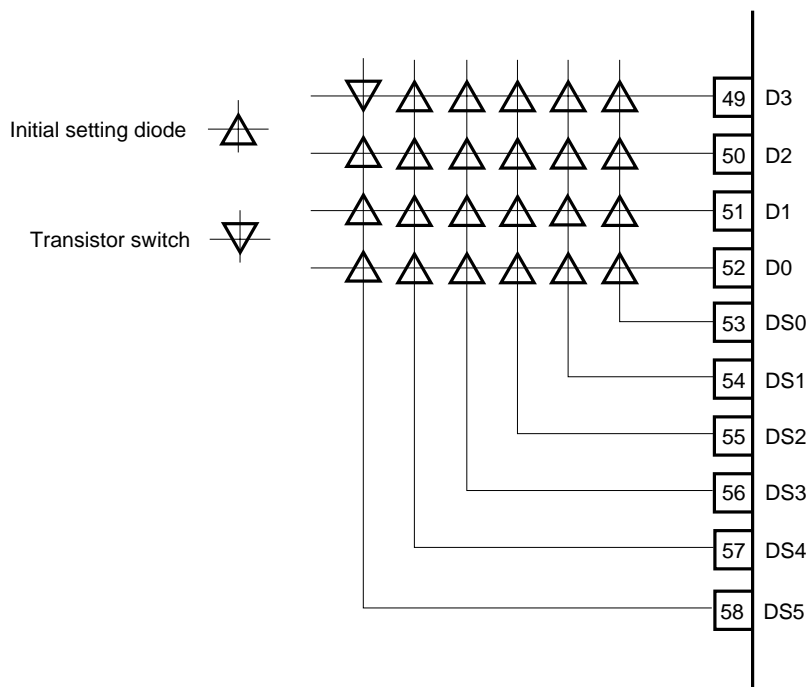
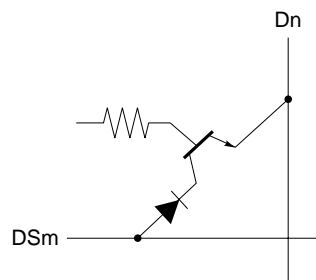

μPD178016GC-051

2.3 Momentary Key Matrix Configuration

Input pin \ Output pin	KEY1 (2)	KEY2 (3)	KEY3 (4)	KEY4 (5)
KS1 (25)	M1	M2	M3	M4
	—	—	—	—
	M1	M2	M3	M4
KS2 (26)	M5	M6	DOWN	UP
	—	—	DOWN	UP
	M5	M6	DOWN	UP
KS3 (27)	PSCAM/ASM	RDS/REGION	TP/SK	PTY
	—	—	TP/SK	—
	—	—	TP/SK	—
KS4 (28)	BAND	CDC	TAPE	DISP/ADJ
	—	—	—	—
	BAND	CDC	TAPE	DISP/ADJ
KS5 (29)	MONO/LOC	VOL DOWN	VOL UP	SEL/LOUD
	—	VOL DOWN	VOL UP	SEL/LOUD
	—	VOL DOWN	VOL UP	SEL/LOUD
KS6 (30)	AUTO	—	—	—
	—	—	—	RANDOM/AMS
	—	INTRO	REPEAT	RANDOM/AMS
KS7 (31)	—	—	—	—
	—	—	—	—
	—	—	—	—
KS8 (32)	POWER	—	—	—
	—	—	—	—
	POWER	—	—	EJECT
	POWER	—	—	—
	—	—	—	—
	—	—	—	—

**Remarks 1.** The top line in each row indicates the momentary key that is valid in radio mode, the middle line indicates the key valid in tape mode, and the bottom line indicates the key valid in CD changer mode.

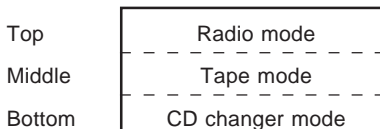

2. Numbers in ( ) indicate the pin numbers of the μPD16431A.

2.4 Momentary Key Matrix Connection

Momentary key switch

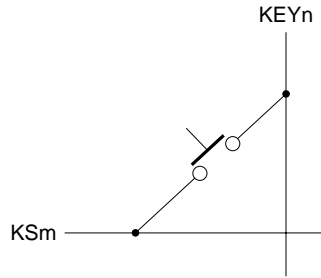

Momentary key switch

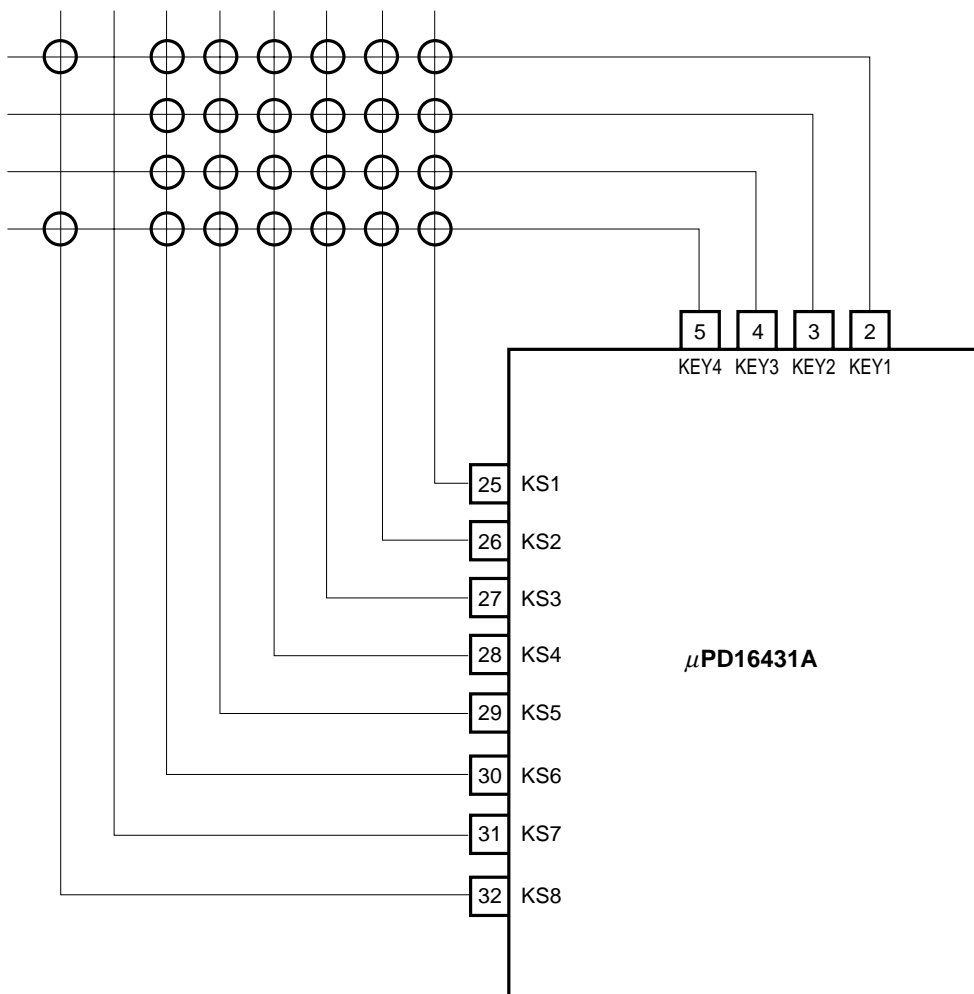

## 2.5 Description of the Key Matrixes

### 2.5.1 Initial setting diode matrix

The initial setting diode matrix is used to determine the function of the μPD178016GC-051. This matrix must be set.

The initial setting diode matrix is read only when the microcontroller is reset by means of power-ON clear. It is ignored at all other times.

- (1) **Switches used to specify the method for detecting a station during auto-tuning**  
AM SD/IF, FM SD/IF
- (2) **Switches used to specify the intermediate frequency for the AM band**  
AMIF1, AMIF2
- (3) **Switch used to specify whether to turn auto-retuning on or off**  
RETUNE
- (4) **Switches related to the clock functions**  
CLK24, CTADJ, CTOFF, FLASH, NOCLK
- (5) **Switches used to specify the electronic volume control function**  
FAD, VOLSEL
- (6) **Switch used to specify whether a beep is output**  
BEEP
- (7) **Switch used to select the destination market (Europe/USA)**  
AMERICA
- (8) **Switch used to validate the use of the REGION key function**  
REGION
- (9) **Switch used to specify whether the mute function is used during PI check of AF**  
NO\_PIM
- (10) **Switches used to specify the AF function**  
AFALL, DEV\_SEL
- (11) **Switches used to select the number of error correction bits when RDS data is decoded**  
ERR\_COR1, ERR\_COR2, ERR\_COR3
- (12) **Switch used to select the method for inputting the POWER key**  
POWER1
- (13) **Switch used to select display during power off**  
POWER2

To set these switches, the respective matrix diodes are either jumpered (1) or left open (0).  
 The functions of the switches in the initial setting diode matrix are summarized below (in alphabetical order).

Initial setting diode	Description												
AFALL	<p>This switch is used to specify the AF function.                      Set the switch as indicated in the following table.</p> <table border="1" data-bbox="337 401 1354 527"> <thead> <tr> <th>AFALL</th> <th>AF function</th> </tr> </thead> <tbody> <tr> <td>0</td> <td>Performs only one-station AF.</td> </tr> <tr> <td>1</td> <td>Performs broadcasting AF.</td> </tr> </tbody> </table> <p>(0: Open, 1: Jumpered)</p>	AFALL	AF function	0	Performs only one-station AF.	1	Performs broadcasting AF.						
AFALL	AF function												
0	Performs only one-station AF.												
1	Performs broadcasting AF.												
AMERICA	<p>This switch is used to select the destination market (Europe/USA).                      Set the switch as indicated in the following table.</p> <table border="1" data-bbox="337 674 1354 800"> <thead> <tr> <th>AMERICA</th> <th>Europe/USA</th> </tr> </thead> <tbody> <tr> <td>0</td> <td>Europe</td> </tr> <tr> <td>1</td> <td>USA</td> </tr> </tbody> </table> <p>(0: Open, 1: Jumpered)</p>	AMERICA	Europe/USA	0	Europe	1	USA						
AMERICA	Europe/USA												
0	Europe												
1	USA												
AMIF1 AMIF2	<p>These switches are used to specify the intermediate frequency in the AM band for the European market.                      The setting of these switches is invalid when the USA market is selected (initial setting diode AMERICA = 1).                      Set the switch as indicated in the following table.</p> <table border="1" data-bbox="337 978 1354 1146"> <thead> <tr> <th>AMIF1</th> <th>AMIF2</th> <th>Intermediate frequency</th> </tr> </thead> <tbody> <tr> <td>0</td> <td>0</td> <td>450 kHz</td> </tr> <tr> <td>0</td> <td>1</td> <td>459 kHz</td> </tr> <tr> <td>1</td> <td>×</td> <td>10.71 MHz</td> </tr> </tbody> </table> <p>(0: Open, 1: Jumpered, ×: Don't care)</p>	AMIF1	AMIF2	Intermediate frequency	0	0	450 kHz	0	1	459 kHz	1	×	10.71 MHz
AMIF1	AMIF2	Intermediate frequency											
0	0	450 kHz											
0	1	459 kHz											
1	×	10.71 MHz											
AM SD/IF FM SD/IF	<p>This switch is used to specify the method used to detect a station during auto-tuning.                      AM SD/IF specifies the method of detecting the AM band, while FM SD/IF specifies the method of detecting the FM band.                      Set these switches as indicated in the following table.</p> <table border="1" data-bbox="337 1346 1354 1514"> <thead> <tr> <th>AM SD/IF FM SD/IF</th> <th>Method used to detect a station</th> </tr> </thead> <tbody> <tr> <td>0</td> <td>Only SD is used.</td> </tr> <tr> <td>1</td> <td>SD and the IF counter are used.</td> </tr> </tbody> </table> <p>(0: Open, 1: Jumpered)</p>	AM SD/IF FM SD/IF	Method used to detect a station	0	Only SD is used.	1	SD and the IF counter are used.						
AM SD/IF FM SD/IF	Method used to detect a station												
0	Only SD is used.												
1	SD and the IF counter are used.												
BEEP	<p>This switch is used to specify whether to output a beep whenever a key entry is accepted.                      Set this switch as indicated in the following table.</p> <table border="1" data-bbox="337 1665 1354 1791"> <thead> <tr> <th>BEEP</th> <th>Beep</th> </tr> </thead> <tbody> <tr> <td>0</td> <td>Not output.</td> </tr> <tr> <td>1</td> <td>Output.</td> </tr> </tbody> </table> <p>(0: Open, 1: Jumpered)</p>	BEEP	Beep	0	Not output.	1	Output.						
BEEP	Beep												
0	Not output.												
1	Output.												

Initial setting diode	Description						
CLK24	<p>This switch is used to select 12-hour or 24-hour clock display. Set this switch as indicated in the following table.</p> <table border="1" data-bbox="418 300 1433 428"> <thead> <tr> <th>CLK24</th> <th>Hour display</th> </tr> </thead> <tbody> <tr> <td>0</td> <td>12-hour clock display (with “AM” or “PM” displayed)</td> </tr> <tr> <td>1</td> <td>24-hour clock display</td> </tr> </tbody> </table> <p>(0: Open, 1: Jumpered)</p>	CLK24	Hour display	0	12-hour clock display (with “AM” or “PM” displayed)	1	24-hour clock display
CLK24	Hour display						
0	12-hour clock display (with “AM” or “PM” displayed)						
1	24-hour clock display						
CTADJ	<p>This switch is used to select whether the clock is adjusted according to RDS data. The clock is not adjusted during power off. When no-clock mode is selected (initial setting diode NOCLK = 1), this setting is invalid. Set this switch as indicated in the following table.</p> <table border="1" data-bbox="418 638 1433 858"> <thead> <tr> <th>CTADJ</th> <th>Adjusting clock with RDS data</th> </tr> </thead> <tbody> <tr> <td>0</td> <td>Does not adjust the clock with RDS data. The clock must be adjusted by the user.</td> </tr> <tr> <td>1</td> <td>Adjusts the clock according to the RDS data. The clock cannot be adjusted by the user. The clock does not operate until the RDS data is input.</td> </tr> </tbody> </table> <p>(0: Open, 1: Jumpered)</p>	CTADJ	Adjusting clock with RDS data	0	Does not adjust the clock with RDS data. The clock must be adjusted by the user.	1	Adjusts the clock according to the RDS data. The clock cannot be adjusted by the user. The clock does not operate until the RDS data is input.
CTADJ	Adjusting clock with RDS data						
0	Does not adjust the clock with RDS data. The clock must be adjusted by the user.						
1	Adjusts the clock according to the RDS data. The clock cannot be adjusted by the user. The clock does not operate until the RDS data is input.						
CTOFF	<p>This switch is used to select how the clock operates in power-off mode. When no-clock mode is selected (initial setting diode NOCLK = 1), this setting is invalid. Set this switch as indicated in the following table.</p> <table border="1" data-bbox="418 1041 1433 1262"> <thead> <tr> <th>CTOFF</th> <th>Clock operation</th> </tr> </thead> <tbody> <tr> <td>0</td> <td>Operates normally.</td> </tr> <tr> <td>1</td> <td>Stops operation. Initializes the clock. The clock can be backed (with low current consumption) when a low level signal is input to the ACC or BATT pin.</td> </tr> </tbody> </table> <p>(0: Open, 1: Jumpered)</p>	CTOFF	Clock operation	0	Operates normally.	1	Stops operation. Initializes the clock. The clock can be backed (with low current consumption) when a low level signal is input to the ACC or BATT pin.
CTOFF	Clock operation						
0	Operates normally.						
1	Stops operation. Initializes the clock. The clock can be backed (with low current consumption) when a low level signal is input to the ACC or BATT pin.						
DEV_SEL	<p>This switch is used to select whether the DEV_LEVEL pin (pin 66) is referenced during AF operation. Set this switch as indicated in the following table.</p> <table border="1" data-bbox="418 1409 1433 1537"> <thead> <tr> <th>DEV_SEL</th> <th>DEV_LEVEL pin</th> </tr> </thead> <tbody> <tr> <td>0</td> <td>Not referenced.</td> </tr> <tr> <td>1</td> <td>Referenced.</td> </tr> </tbody> </table> <p>(0: Open, 1: Jumpered)</p>	DEV_SEL	DEV_LEVEL pin	0	Not referenced.	1	Referenced.
DEV_SEL	DEV_LEVEL pin						
0	Not referenced.						
1	Referenced.						

Initial setting diode	Description																																
ERR_COR1 ERR_COR2 ERR_COR3	<p>These switches are used to select the number of error correction bits when RDS data is decoded. Set these switches as indicated in the following table.</p> <table border="1" data-bbox="337 302 1356 617"> <thead> <tr> <th>ERR_COR1</th> <th>ERR_COR2</th> <th>ERR_COR3</th> <th>Error correction</th> </tr> </thead> <tbody> <tr> <td>0</td> <td>0</td> <td>0</td> <td>Error is not corrected.</td> </tr> <tr> <td>0</td> <td>0</td> <td>1</td> <td>1-bit correction</td> </tr> <tr> <td>0</td> <td>1</td> <td>0</td> <td>2-bit correction</td> </tr> <tr> <td>0</td> <td>1</td> <td>1</td> <td>3-bit correction</td> </tr> <tr> <td>1</td> <td>0</td> <td>0</td> <td>4-bit correction</td> </tr> <tr> <td>1</td> <td>0</td> <td>1</td> <td>5-bit correction</td> </tr> <tr> <td>1</td> <td>1</td> <td>×</td> <td>Error is not corrected.</td> </tr> </tbody> </table> <p>(0: Open, 1: Jumpered, ×: Don't care)</p>	ERR_COR1	ERR_COR2	ERR_COR3	Error correction	0	0	0	Error is not corrected.	0	0	1	1-bit correction	0	1	0	2-bit correction	0	1	1	3-bit correction	1	0	0	4-bit correction	1	0	1	5-bit correction	1	1	×	Error is not corrected.
ERR_COR1	ERR_COR2	ERR_COR3	Error correction																														
0	0	0	Error is not corrected.																														
0	0	1	1-bit correction																														
0	1	0	2-bit correction																														
0	1	1	3-bit correction																														
1	0	0	4-bit correction																														
1	0	1	5-bit correction																														
1	1	×	Error is not corrected.																														
FAD	<p>This switch is used to select whether the fader of the electronic volume control is adjusted. Set this switch as indicated in the following table.</p> <table border="1" data-bbox="337 762 1356 890"> <thead> <tr> <th>FAD</th> <th>Fader function</th> </tr> </thead> <tbody> <tr> <td>0</td> <td>Adjusted.</td> </tr> <tr> <td>1</td> <td>Not adjusted.</td> </tr> </tbody> </table> <p>(0: Open, 1: Jumpered)</p>	FAD	Fader function	0	Adjusted.	1	Not adjusted.																										
FAD	Fader function																																
0	Adjusted.																																
1	Not adjusted.																																
FLASH	<p>This switch is used to select the method of displaying “:” (colon). The setting of this switch is invalid in no-clock mode (initial setting diode NOCLK = 0). Set this switch as indicated in the following table.</p> <table border="1" data-bbox="337 1066 1356 1230"> <thead> <tr> <th>FLASH</th> <th>Colon (:) display</th> </tr> </thead> <tbody> <tr> <td>0</td> <td>Blinks at 1 Hz (duty factor: 60 %). However, extinguished in power-off mode.</td> </tr> <tr> <td>1</td> <td>Lights.</td> </tr> </tbody> </table> <p>(0: Open, 1: Jumpered)</p>	FLASH	Colon (:) display	0	Blinks at 1 Hz (duty factor: 60 %). However, extinguished in power-off mode.	1	Lights.																										
FLASH	Colon (:) display																																
0	Blinks at 1 Hz (duty factor: 60 %). However, extinguished in power-off mode.																																
1	Lights.																																
NOCLK	<p>This switch is used to specify whether the clock is to be provided. Set this switch as indicated in the following table.</p> <table border="1" data-bbox="337 1375 1356 1566"> <thead> <tr> <th>NOCLK</th> <th>Availability of the clock</th> </tr> </thead> <tbody> <tr> <td>0</td> <td>The clock is available.</td> </tr> <tr> <td>1</td> <td>The clock is unavailable. The clock can be backed up (with low current consumption) when a low level signal is input to the ACC or BATT pin.</td> </tr> </tbody> </table> <p>(0: Open, 1: Jumpered)</p>	NOCLK	Availability of the clock	0	The clock is available.	1	The clock is unavailable. The clock can be backed up (with low current consumption) when a low level signal is input to the ACC or BATT pin.																										
NOCLK	Availability of the clock																																
0	The clock is available.																																
1	The clock is unavailable. The clock can be backed up (with low current consumption) when a low level signal is input to the ACC or BATT pin.																																
NO_PIM	<p>This switch is used to select whether PI check of AF is muted. Set this switch as indicated in the following table.</p> <table border="1" data-bbox="337 1711 1356 1839"> <thead> <tr> <th>NO_PIM</th> <th>Muting of PI check of AF</th> </tr> </thead> <tbody> <tr> <td>0</td> <td>Muted.</td> </tr> <tr> <td>1</td> <td>Not muted.</td> </tr> </tbody> </table> <p>(0: Open, 1: Jumpered)</p>	NO_PIM	Muting of PI check of AF	0	Muted.	1	Not muted.																										
NO_PIM	Muting of PI check of AF																																
0	Muted.																																
1	Not muted.																																



Initial setting diode	Description						
POWER1	<p>This switch is used to select the method of inputting the <b>POWER</b> key. Set this switch as indicated in the table below.</p> <table border="1" data-bbox="415 302 1432 432"> <thead> <tr> <th>POWER1</th> <th>Input of <b>POWER</b> key</th> </tr> </thead> <tbody> <tr> <td>0</td> <td>Input port (pin 42)</td> </tr> <tr> <td>1</td> <td>LCD driver</td> </tr> </tbody> </table> <p>(0: Open, 1: Jumpered)</p>	POWER1	Input of <b>POWER</b> key	0	Input port (pin 42)	1	LCD driver
POWER1	Input of <b>POWER</b> key						
0	Input port (pin 42)						
1	LCD driver						
POWER2	<p>This switch is used to select the display in power-off mode. The setting of this switch is invalid in no-clock mode (initial setting diode NOCLK = 1) or when the power-off clock operation is stopped (initial setting diode CTOFF = 1). Set this switch as indicated in the table below.</p> <table border="1" data-bbox="415 638 1432 798"> <thead> <tr> <th>POWER2</th> <th>Display in power-off mode</th> </tr> </thead> <tbody> <tr> <td>0</td> <td>No display</td> </tr> <tr> <td>1</td> <td>Clock display The clock cannot, however, be adjusted in power-off mode.</td> </tr> </tbody> </table> <p>(0: Open, 1: Jumpered)</p>	POWER2	Display in power-off mode	0	No display	1	Clock display The clock cannot, however, be adjusted in power-off mode.
POWER2	Display in power-off mode						
0	No display						
1	Clock display The clock cannot, however, be adjusted in power-off mode.						
REGION	<p>This switch is used to validate the use of the <b>REGION</b> key. Set this switch as indicated in the following table.</p> <table border="1" data-bbox="415 947 1432 1077"> <thead> <tr> <th>REGION</th> <th>Use of <b>REGION</b> key</th> </tr> </thead> <tbody> <tr> <td>0</td> <td>Invalid (REGION mode is always on.)</td> </tr> <tr> <td>1</td> <td>Valid</td> </tr> </tbody> </table> <p>(0: Open, 1: Jumpered)</p>	REGION	Use of <b>REGION</b> key	0	Invalid (REGION mode is always on.)	1	Valid
REGION	Use of <b>REGION</b> key						
0	Invalid (REGION mode is always on.)						
1	Valid						
RETUNE	<p>This switch is used to specify whether to turn auto-retuning on or off. Auto-retuning is performed only when RDS mode is not set. Set this switch as indicated in the following table.</p> <table border="1" data-bbox="415 1253 1432 1383"> <thead> <tr> <th>RETUNE</th> <th>Auto-retuning on/off</th> </tr> </thead> <tbody> <tr> <td>0</td> <td>Off</td> </tr> <tr> <td>1</td> <td>On</td> </tr> </tbody> </table> <p>(0: Open, 1: Jumpered)</p>	RETUNE	Auto-retuning on/off	0	Off	1	On
RETUNE	Auto-retuning on/off						
0	Off						
1	On						
VOLSEL	<p>This switch is used to select between two types of electronic volume ICs. Set this switch as indicated in the following table.</p> <table border="1" data-bbox="415 1528 1432 1659"> <thead> <tr> <th>VOLSEL</th> <th>Description</th> </tr> </thead> <tbody> <tr> <td>0</td> <td>Electronic volume IC (SGS-TDA7313) is used.</td> </tr> <tr> <td>1</td> <td>Electronic volume IC (PHILIPS TEA6320) is used.</td> </tr> </tbody> </table> <p>(0: Open, 1: Jumpered)</p>	VOLSEL	Description	0	Electronic volume IC (SGS-TDA7313) is used.	1	Electronic volume IC (PHILIPS TEA6320) is used.
VOLSEL	Description						
0	Electronic volume IC (SGS-TDA7313) is used.						
1	Electronic volume IC (PHILIPS TEA6320) is used.						

**2.5.2 Transistor switch**

The following transistor switch is used:

**METAL**

Unlike the initial setting diodes, the transistor switch can always be switched.

The setting of the switch is recognized when the setting coincides two times during 1-ms scanning.

Transistor switch	Description						
<p><b>METAL</b></p>	<p>This switch is used to change the state of METAL between on and off each time it is pressed.</p> <table border="1" data-bbox="337 541 1354 667"> <thead> <tr> <th data-bbox="337 541 488 583">METAL</th> <th data-bbox="488 541 1354 583">METAL state</th> </tr> </thead> <tbody> <tr> <td data-bbox="337 583 488 625">0</td> <td data-bbox="488 583 1354 625">Off</td> </tr> <tr> <td data-bbox="337 625 488 667">1</td> <td data-bbox="488 625 1354 667">On</td> </tr> </tbody> </table> <p>(0: Open, 1: Jumpered)</p>	METAL	METAL state	0	Off	1	On
METAL	METAL state						
0	Off						
1	On						

**2.5.3 Momentary keys**

The **POWER** key is effective even when pressed together with another momentary key. Pressing any other two keys together is invalid, and it is assumed that no key has been pressed.

A BEEP sound (BEEP pin, pin 59) is output for 50 ms when a valid combination is pressed.

The functions of the momentary keys are described below (in alphabetical order).

Momentary key	Description												
<p><b>AUTO</b></p>	<p>This key is used to select the auto or manual mode.                      This key is valid in radio mode.                      Each time it is pressed, auto or manual mode is selected alternately.                      In auto mode, the LCD indicator "AUTO" lights.                      Manual mode is set in the initial state when the power is first applied.                      The functions of the <b>UP</b> and <b>DOWN</b> keys differ depending on the selected mode.</p> <ul style="list-style-type: none"> <li>• <b>Auto mode</b>                          The <b>UP</b> / <b>DOWN</b> keys are used to start auto seek up/down operation.</li> <li>• <b>Manual mode</b>                          The <b>UP</b> / <b>DOWN</b> keys are used to start manual seek up/down operation.</li> </ul>												
<p><b>BAND</b></p>	<p>This key is used to switch a band or to select radio mode.</p> <p><b>(1) In radio mode</b>                      This key is used to select a band. The frequency of the selected band will be displayed. The LCD indicator corresponding to the selected band ("FM1"/"FM2"/"FM3"/"MW"/"LW") lights.                      Each time this key is pressed, the band is changed as follows:</p> <div style="border: 1px solid black; padding: 5px; width: fit-content; margin: 10px auto;"> <p>→FM1→FM2→FM3→MW/LW→</p> </div> <p>The FM1 band is selected in the initial state when the power is first applied.                      The outputs of the BAND0 and BAND1 pins are changed depending on the selected band, as indicated in the following table.</p> <table border="1" style="margin: 10px auto;"> <thead> <tr> <th>Band</th> <th>BAND0 pin (pin 24)</th> <th>BAND1 pin (pin 25)</th> </tr> </thead> <tbody> <tr> <td>FM</td> <td>1</td> <td>0</td> </tr> <tr> <td>MW</td> <td>0</td> <td>0</td> </tr> <tr> <td>LW</td> <td>0</td> <td>1</td> </tr> </tbody> </table> <p>(0: Low, 1: High)</p> <p><b>(2) In CD changer/tape mode</b>                      This key is used to select radio mode.                      The frequency is displayed for two seconds then PS is displayed for three seconds (if there is no PS, the frequency is displayed for five seconds). Subsequently, the display returns to normal.                      The LCD indicator indicating the most-recently selected band ("FM1"/"FM2"/"FM3"/"MW"/"LW") lights.</p>	Band	BAND0 pin (pin 24)	BAND1 pin (pin 25)	FM	1	0	MW	0	0	LW	0	1
Band	BAND0 pin (pin 24)	BAND1 pin (pin 25)											
FM	1	0											
MW	0	0											
LW	0	1											
<p><b>CDC</b></p>	<p>This key is used to select CD changer mode in radio or tape mode, and is used to play back or pause the CD changer in CD changer mode.</p> <p><b>(1) In radio/tape mode</b>                      Selects CD changer mode.</p> <p><b>(2) In CD changer mode</b>                      Plays back or pauses the CD changer.</p>												

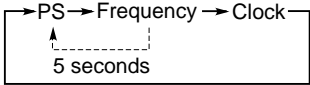
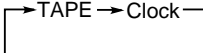
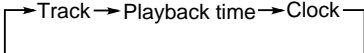
Momentary key	Description
<p><b>DISP/ADJ</b></p>	<p>When this key is held down for two seconds, clock adjustment display mode is set. When the key is held down for less than two seconds, the LCD panel display is changed.</p> <p>Clock adjustment display mode is not selected when initial setting diode NOCLK = 1 or when initial setting diode CTADJ = 1. Clock display is not performed when initial setting diode NOCLK = 1.</p> <p><b>(1) When used as LCD panel display select key</b> Each time this key is pressed, the display is changed as follows:</p> <ul style="list-style-type: none"> <li>• <b>When traffic information is received in radio mode, or CD changer/tape mode</b></li> </ul>  <p>PS display is performed if RDS PS data has been input (for details, see <b>Section 5.3</b>). <ul style="list-style-type: none"> <li>• <b>In tape mode</b></li> </ul>  <ul style="list-style-type: none"> <li>• <b>In CD changer mode</b></li> </ul>  <p><b>(2) Clock adjustment display mode</b> The clock display blinks, and LCD indicator “:” lights. For details of clock adjustment, refer to the description of the <b>UP</b> and <b>DOWN</b> keys. The second digits are cleared (to 0 seconds) upon the completion of time adjustment using the <b>DISP/ADJ</b> key during clock adjustment display. The clock adjustment display is cleared when the system is started by pressing the <b>POWER</b> key.</p> </p>
<p><b>EJECT</b></p>	<p>This key is used to eject the tape in power-on mode. It is used to select radio mode in tape mode.</p>
<p><b>INTRO</b></p>	<p>This key turns on/off disc introduction scan mode when it is held down for more than two seconds. It turns on/off introduction scan mode when pressed for less than two seconds. This key is valid in CD changer mode.</p> <ul style="list-style-type: none"> <li>• <b>Introduction scan</b> When introduction scan mode is selected, the first ten seconds of each track of the disc currently being played back are scanned. During introduction scanning, the track number blinks.</li> <li>• <b>Disc introduction scan</b> When disc introduction scan mode is selected, the first ten seconds of each track of all the discs in the magazine of the CD changer are scanned. During disc introduction scanning, the disc number blinks, and LCD indicator “ALL” lights. When system is started by pressing the <b>POWER</b> key, both introduction scan mode and disc introduction scan mode are turned off.</li> </ul>

Momentary key	Description																																																																																										
<b>M1</b>	<p>These keys are used to call and write to the preset memory in radio mode. In CD changer mode, they are used to directly select a disc.</p> <p><b>(1) In radio mode</b></p> <p>The procedures for calling and writing to the preset memory are described below.</p> <table border="1" style="width: 100%;"> <thead> <tr> <th style="width: 20%;">Operation</th> <th>Description</th> </tr> </thead> <tbody> <tr> <td>Call</td> <td>Pressing any one of keys <b>M1</b> to <b>M6</b>, then releasing it within two seconds, calls the contents of the preset memory location corresponding to the pressed key. When one of these keys is pressed, the LCD panel switches to the frequency display.</td> </tr> <tr> <td>Write</td> <td>Pressing any one of keys <b>M1</b> to <b>M6</b>, and holding it down for at least two seconds, causes the frequency to which the device is tuned to be written to the preset memory location corresponding to the pressed key. When one of these keys is pressed, the LCD panel switches to the frequency display or to the preset display when the frequency is written.</td> </tr> </tbody> </table> <p>The frequency is displayed for two seconds then PS is displayed for three seconds (if there is no PS, the frequency is displayed for five seconds), after which the display returns to normal. When a frequency is displayed, the preset number corresponding to the pressed key is displayed, and LCD indicator "CH" lights.</p> <p>One station in each of the FM1, FM2, FM3, and AM bands can be stored to one key; therefore, a total of 24 stations can be stored.</p> <p>The PI code, PS code, and AF list are also written to the preset memory.</p> <p>In the initial state after the power is first applied, the following frequencies are written to the preset memory.</p> <p><b>(Region: Europe)</b></p> <table border="1" style="width: 100%;"> <thead> <tr> <th>Band</th> <th>M1</th> <th>M2</th> <th>M3</th> <th>M4</th> <th>M5</th> <th>M6</th> </tr> </thead> <tbody> <tr> <td>FM1 (MHz)</td> <td>87.50</td> <td>89.90</td> <td>97.90</td> <td>105.90</td> <td>107.90</td> <td>87.50</td> </tr> <tr> <td>FM2 (MHz)</td> <td>87.50</td> <td>87.50</td> <td>87.50</td> <td>87.50</td> <td>87.50</td> <td>87.50</td> </tr> <tr> <td>FM3 (MHz)</td> <td>87.50</td> <td>87.50</td> <td>87.50</td> <td>87.50</td> <td>87.50</td> <td>87.50</td> </tr> <tr> <td>AM (kHz)</td> <td>144</td> <td>153</td> <td>522</td> <td>603</td> <td>1 404</td> <td>144</td> </tr> </tbody> </table> <p><b>(Region: USA)</b></p> <table border="1" style="width: 100%;"> <thead> <tr> <th>Band</th> <th>M1</th> <th>M2</th> <th>M3</th> <th>M4</th> <th>M5</th> <th>M6</th> </tr> </thead> <tbody> <tr> <td>FM1 (MHz)</td> <td>87.50</td> <td>89.90</td> <td>97.90</td> <td>105.90</td> <td>107.90</td> <td>87.50</td> </tr> <tr> <td>FM2 (MHz)</td> <td>87.50</td> <td>87.50</td> <td>87.50</td> <td>87.50</td> <td>87.50</td> <td>87.50</td> </tr> <tr> <td>FM3 (MHz)</td> <td>87.50</td> <td>87.50</td> <td>87.50</td> <td>87.50</td> <td>87.50</td> <td>87.50</td> </tr> <tr> <td>AM (kHz)</td> <td>530</td> <td>820</td> <td>1 120</td> <td>1 420</td> <td>1 720</td> <td>530</td> </tr> </tbody> </table> <p><b>(2) In CD changer mode</b></p> <p>These keys are used to directly select discs in CD changer mode.</p> <table border="1" style="width: 100%;"> <thead> <tr> <th>Key</th> <th>Description</th> </tr> </thead> <tbody> <tr> <td style="text-align: center;"><b>M1</b></td> <td>Plays disk 1.</td> </tr> <tr> <td style="text-align: center;"><b>M2</b></td> <td>Plays disk 2.</td> </tr> <tr> <td style="text-align: center;"><b>M3</b></td> <td>Plays disk 3.</td> </tr> <tr> <td style="text-align: center;"><b>M4</b></td> <td>Plays disk 4.</td> </tr> <tr> <td style="text-align: center;"><b>M5</b></td> <td>Plays disk 5.</td> </tr> <tr> <td style="text-align: center;"><b>M6</b></td> <td>Plays disk 6.</td> </tr> </tbody> </table>	Operation	Description	Call	Pressing any one of keys <b>M1</b> to <b>M6</b> , then releasing it within two seconds, calls the contents of the preset memory location corresponding to the pressed key. When one of these keys is pressed, the LCD panel switches to the frequency display.	Write	Pressing any one of keys <b>M1</b> to <b>M6</b> , and holding it down for at least two seconds, causes the frequency to which the device is tuned to be written to the preset memory location corresponding to the pressed key. When one of these keys is pressed, the LCD panel switches to the frequency display or to the preset display when the frequency is written.	Band	M1	M2	M3	M4	M5	M6	FM1 (MHz)	87.50	89.90	97.90	105.90	107.90	87.50	FM2 (MHz)	87.50	87.50	87.50	87.50	87.50	87.50	FM3 (MHz)	87.50	87.50	87.50	87.50	87.50	87.50	AM (kHz)	144	153	522	603	1 404	144	Band	M1	M2	M3	M4	M5	M6	FM1 (MHz)	87.50	89.90	97.90	105.90	107.90	87.50	FM2 (MHz)	87.50	87.50	87.50	87.50	87.50	87.50	FM3 (MHz)	87.50	87.50	87.50	87.50	87.50	87.50	AM (kHz)	530	820	1 120	1 420	1 720	530	Key	Description	<b>M1</b>	Plays disk 1.	<b>M2</b>	Plays disk 2.	<b>M3</b>	Plays disk 3.	<b>M4</b>	Plays disk 4.	<b>M5</b>	Plays disk 5.	<b>M6</b>	Plays disk 6.
Operation		Description																																																																																									
Call		Pressing any one of keys <b>M1</b> to <b>M6</b> , then releasing it within two seconds, calls the contents of the preset memory location corresponding to the pressed key. When one of these keys is pressed, the LCD panel switches to the frequency display.																																																																																									
Write		Pressing any one of keys <b>M1</b> to <b>M6</b> , and holding it down for at least two seconds, causes the frequency to which the device is tuned to be written to the preset memory location corresponding to the pressed key. When one of these keys is pressed, the LCD panel switches to the frequency display or to the preset display when the frequency is written.																																																																																									
Band		M1	M2	M3	M4	M5	M6																																																																																				
FM1 (MHz)		87.50	89.90	97.90	105.90	107.90	87.50																																																																																				
FM2 (MHz)	87.50	87.50	87.50	87.50	87.50	87.50																																																																																					
FM3 (MHz)	87.50	87.50	87.50	87.50	87.50	87.50																																																																																					
AM (kHz)	144	153	522	603	1 404	144																																																																																					
Band	M1	M2	M3	M4	M5	M6																																																																																					
FM1 (MHz)	87.50	89.90	97.90	105.90	107.90	87.50																																																																																					
FM2 (MHz)	87.50	87.50	87.50	87.50	87.50	87.50																																																																																					
FM3 (MHz)	87.50	87.50	87.50	87.50	87.50	87.50																																																																																					
AM (kHz)	530	820	1 120	1 420	1 720	530																																																																																					
Key	Description																																																																																										
<b>M1</b>	Plays disk 1.																																																																																										
<b>M2</b>	Plays disk 2.																																																																																										
<b>M3</b>	Plays disk 3.																																																																																										
<b>M4</b>	Plays disk 4.																																																																																										
<b>M5</b>	Plays disk 5.																																																																																										
<b>M6</b>	Plays disk 6.																																																																																										
<b>M2</b>																																																																																											
<b>M3</b>																																																																																											
<b>M4</b>																																																																																											
<b>M5</b>																																																																																											
<b>M6</b>																																																																																											

Momentary key	Description
<p><b>MONO/LOC</b></p>	<p>This key acts as a LOCAL/DX setting key when held down for at least two seconds. When released within two seconds, it acts as a forced MONO ON/OFF key.</p> <ul style="list-style-type: none"> <li> <p><b>Forced MONO ON/OFF</b></p> <p>When an FM band is selected in radio mode, pressing this key switches forced MONO mode on or off. In forced MONO mode, LCD indicator “MONO” appears. The “STEREO” indicator is forcibly turned off. In forced MONO mode, MONO pin (pin 44) outputs a low level signal.</p> </li> <li> <p><b>LOCAL/DX setting</b></p> <p>In radio mode, pressing this key switches the setting of LOCAL/DX. In LOCAL mode, LCD indicator “LOC” appears, and the LOCAL pin (pin 23) outputs a high level signal. The LOCAL pin outputs a high level signal, regardless of the setting, in auto-storage mode.</p> </li> </ul> <p>Forced MONO mode and DX setting are turned off in the initial state after the power is first applied.</p>
<p><b>POWER</b></p>	<p>This key turns the power to the system on/off.</p>
<p><b>PSCAN/ASM</b></p>	<p>This key is used to perform auto-storage when it is held down for two seconds. When it is released within two seconds, preset memory scan is performed. This key is valid in radio mode.</p> <ul style="list-style-type: none"> <li> <p><b>For preset memory scan</b></p> <p>If a station other than a preset station is currently being received, the preset memory contents are sequentially called for five seconds each, starting from M1, as shown below. If a preset station is currently being received, the preset memory contents are sequentially called for five seconds each, starting from the next station (for example, if M3 is currently being received, calling starts from M4).</p> <div data-bbox="656 1010 1044 1066" style="text-align: center;"> <pre> graph LR     M1 --&gt; M2 --&gt; M3 --&gt; M4 --&gt; M5 --&gt; M6             </pre> </div> </li> <li> <p>When the next preset memory contents are called, a beep is issued for 50 ms. During preset memory scanning, LCD indicator “PSCAN” appears. If there is a PS code, the PS code blinks for three seconds after the frequency has been displayed, blinking, for two seconds. If there is no PS code, the frequency is displayed, blinking, for five seconds.</p> </li> <li> <p><b>For auto-storage operation</b></p> <p>During auto-storage, LCD indicator “ASM” appears. At this time, the LCD panel switches to the frequency display. Stations are searched from the lowest toward the highest frequency of the band currently being received. The frequencies are written to the preset memory. Searched stations are set to LOCAL in the first round of searching by the output signal of the LOCAL pin (pin 23), and to DX in the second round. If six or more stations cannot be searched in the first round, the second round of search is performed. If a detected station is an RDS station, the PI code is also written to the preset memory. If stations having the same PI code are detected during auto-storage, the signal meter values input from S • METER (pin 3) are compared, and only that having the highest frequency is written. Upon the completion of auto-storage, six of the detected stations are selected starting from that having the highest signal meter value (RDS stations take precedence), and are written into preset memory, starting from the station having the lowest frequency and starting from M1. If the number of detected stations is less than six, the remaining preset memory locations remain as is, retaining the contents they had before auto-storage was started. If search is aborted, all the preset memory locations retain the contents they had before the start of auto-storage. When <b>TP/SK</b> is on, only those stations broadcasting traffic information (stations with TP or SK) are written.</p> </li> </ul>

Momentary key	Description
<p style="text-align: center;"><b>PTY</b></p>	<p>This key is used to display and search for a program based on a PTY (program type) from among the RDS data.</p> <p>This key is valid while an FM band station is being received in radio mode and when the <b>TP/SK</b> key is off. While a program type is being displayed, or while a search is being made for a program type, LCD indicator "PTY" appears.</p> <p>Pressing this key once, while the device is tuned to an RDS station, causes the current program type to be displayed. If the station currently being received is other than an RDS station, symbol "NONE" appears in the LCD indicator, indicating that the program does not have a program type.</p> <p>A program type is displayed for five seconds after the key has been pressed. Within those five seconds, each time the key is pressed, the program type is switched. The displayed program type changes as follows each time this key is pressed. If the key is pressed for 0.5 seconds or longer while a PTY is displayed, the display changes every 300 ms.</p> <p>When the desired program type is displayed, pressing either the <b>UP</b> or <b>DOWN</b> key during the five seconds the program type is displayed instigates a search of the entire band for an RDS station broadcasting a program of that program type. When a corresponding station is detected, the PTY display is automatically cleared.</p> <div style="text-align: center; border: 1px solid black; padding: 5px; margin: 10px auto; width: fit-content;"> <p>→PTY code 0→PTY code 1→PTY code 2→...→PTY code 16</p> <p style="margin: 0;">"NONE"      "NEWS"      "AFFAIRES"      "OTHER M"</p> </div> <p>If the <b>UP</b>, <b>DOWN</b>, or <b>PTY</b> key is not pressed within five seconds while a program type is displayed, the PTY display is automatically cleared, the "PTY" indicator is turned off, and PS display (or frequency display) is performed.</p> <p>The PTY display is cleared when the system is started by pressing the <b>POWER</b> key.</p>
<p style="text-align: center;"><b>RANDOM/AMS</b></p>	<p>This key is used as an AMS ON/OFF setting key in tape mode.</p> <p>If this key is held down for at least two seconds in CD changer mode, it can be used as a disc random mode ON/OFF setting key. If the key is released within two seconds, it is used as a random mode ON/OFF setting key.</p> <p><b>(1) AMS ON/OFF setting</b></p> <p>This key is used as an AMS (Auto Music Search) control key.</p> <p>Each time this key is pressed, AMS is alternately turned ON/OFF.</p> <p>While AMS is ON, LCD indicator "AMS" appears.</p> <p><b>(2) Disc random mode ON/OFF setting</b></p> <p>Each time this key is pressed, the disc random mode is turned ON/OFF.</p> <p>During disk random mode operation, LCD indicators "RANDOM" and "ALL" appear.</p> <p><b>(3) Random mode ON/OFF setting</b></p> <p>Each time this key is pressed, the random mode is alternately turned ON/OFF.</p> <p>During random mode operation, LCD indicator "RANDOM" appears.</p> <p>In the initial state after the power is first applied, random mode and disc random mode are turned OFF.</p>

Momentary key	Description
<p><b>RDS/REGION</b></p>	<p>This key acts as a REGION mode ON/OFF key when held down for two seconds. When it is released within two seconds, this key acts as an RDS mode ON/OFF key.</p> <p><b>(1) RDS mode ON/OFF setting</b>            This key is valid while an FM band is being received in radio mode.            When RDS mode is ON, LCD indicator "RDS" appears.            While RDS mode is selected, the following processing is performed.</p> <ul style="list-style-type: none"> <li>• AF operation and best station are performed.</li> <li>• PI seek is performed if best station has failed.</li> <li>• RDS seek is performed for seek and auto-retuning.</li> </ul> <p><b>(2) REGION mode ON/OFF setting</b>            This key is used to select the method used to judge the PI code of the RDS station to which the device is switched when AF switching to an RDS station in the FM band and PI seek occur.            This key is valid while an FM band is being received in radio mode.            If initial setting diode REGION is open, however, turning ON/OFF REGION mode is invalid, and RDS mode ON/OFF setting becomes valid as soon as this key is pressed.            When REGION mode is ON, LCD indicator "REGION" appears.            When PI codes are compared in REGION mode, 12 bits of the PI codes, except the area cover codes of the PI codes, are compared. If the area cover code is 0 to 2, however, 16 bits of a PI code are compared.            When REGION mode is OFF, 16 bits are compared when PI codes are compared.</p> <p>RDS mode and REGION mode are OFF in the initial state after the power is first applied.</p>
<p><b>REPEAT</b></p>	<p>This key acts as the disc repeat mode ON/OFF key when it is held down for two seconds. When it is released within two seconds, this key acts as the repeat mode ON/OFF key. This key is valid in CD changer mode.</p> <ul style="list-style-type: none"> <li>• <b>Repeat mode ON/OFF setting</b>              When repeat mode is ON, only the track currently being played is repeated.              In repeat mode, LCD indicator "REPEAT" appears.</li> <li>• <b>Disc repeat mode ON/OFF setting</b>              When disc repeat mode is ON, all the tracks of the disc currently being played are repeated.              In disc repeat mode, LCD indicators "REPEAT" and "ALL" appear.</li> </ul> <p>Both repeat mode and disc repeat mode are OFF in the initial state after the power is first applied.</p>



Momentary key	Description
<p><b>SEL/LOUD</b></p>	<p>This key acts as the loudness ON/OFF key when it is held down for two seconds. When it is released within two seconds, this key selects the electronic volume control function.</p> <p><b>(1) Selecting the electronic volume control function</b>            Each time this key is pressed to select the electronic volume control function, the mode changes as illustrated below.            If initial setting diode FAD is jumpered, fader mode cannot be used.</p> <div data-bbox="602 485 1252 659" style="text-align: center;"> <pre>           graph LR             Normal --&gt; Volume             Volume --&gt; Bass             Bass --&gt; Treble             Treble --&gt; Balance             Balance --&gt; Fader             Fader --&gt; Volume             subgraph 5_seconds [5 seconds]               Volume               Bass               Treble               Balance               Fader             end           </pre> </div> <p>Each time the key is pressed, one of the above modes is set for five seconds. In each electronic volume control mode, adjustment can be made by using the <b>VOL UP</b> or <b>VOL DOWN</b> key. For details, refer to the description of the <b>VOL UP</b> and <b>VOL DOWN</b> keys.            The volume can be adjusted in normal display mode.            In each of the above modes, "VOL", "BAS", "TRE", "BAL", or "FAD" and the set value are displayed.            After five seconds, normal display mode is restored.</p> <p><b>(2) Loudness ON/OFF setting</b>            When loudness mode is ON, LCD indicator "LOUD" appears.            At this time, the LOUD pin (pin 48) outputs a high level signal.            The volume control display is cleared when the system is started by pressing the <b>POWER</b> key.            Loudness mode is off in the initial state when the power is first applied.</p>
<p><b>TAPE</b></p>	<p><b>(1) In radio/CD changer mode</b>            This key is used to select tape mode.</p> <p><b>(2) In tape mode</b>            This key switches the tape side between A and B.</p>
<p><b>TP/SK</b></p>	<p>This key is used to turn ON/OFF traffic information interrupt enable mode (TP/SK mode). This key is valid in power-on mode. While an AM band is being received, however, pressing this key causes the FM1 band to be selected.            TP/SK mode is turned ON/OFF for each band (FM1, FM2, and FM3).</p> <ul style="list-style-type: none"> <li> <b>TP/SK mode ON/OFF setting</b>                If the device is tuned to an FM band station, this key is valid even in CD changer/tape mode. When TP/SK mode is selected, LCD indicator "TP/SK" appears.                In TP/SK mode, auto-seek detects traffic information stations only.                While TP/SK mode is ON, the operations performed are as follows.             </li> <li> <b>While traffic information is being received</b>                In radio mode, the SK MUTE pin (pin 19) outputs a high level signal.                The TA/DK pin (pin 18) outputs a low level signal.                In CD changer/tape mode, radio mode is selected, and traffic information is output.             </li> <li> <b>While traffic information is not being received</b>                In radio mode, the SK MUTE pin (pin 19) outputs a low level signal.                The TA/DK pin (pin 18) outputs a high level signal.                TP/SK mode is OFF in the initial state after power is first applied.             </li> </ul>

Momentary key	Description
<div style="border: 1px solid black; padding: 2px; width: fit-content; margin-bottom: 2px;">UP</div> <div style="border: 1px solid black; padding: 2px; width: fit-content;">DOWN</div>	<p>These keys act as auto-seek and manual seek keys in radio mode. In CD changer mode, they act as up and down keys for track/search. In tape mode, they act as FF and REW keys. While the clock is displayed, these keys are used to adjust the clock.</p> <p><b>(1) In radio mode</b></p> <ul style="list-style-type: none"> <li> <p>• <b>When used for auto-seek</b></p> <p>While the "AUTO" indicator is lit in radio mode, these keys are used to perform auto-seek. Pressing a key instigates a search for a station. Once a station has been detected, the device receives that station.</p> <p>In RDS mode, RDS seek is performed. In TP/SK mode, TP/SK seek is performed. In PTY display mode, PTY seek is performed.</p> </li> <li> <p>• <b>When used for manual seek</b></p> <p>While the "AUTO" indicator is not lit in radio mode, these keys are used for manual seek. Each time the key is pressed, the frequency is increased or decreased by 1 step (1 channel separation), respectively. When either key is pressed and held down for about 0.5 seconds, the frequency is continuously increased or decreased at a rate of about one step every 50 ms, respectively, until the key is released.</p> <p>In PTY display mode, PTY seek is performed.</p> </li> </ul> <p><b>(2) In tape mode</b></p> <p>Pressing the <b>UP</b> key fast-forwards the tape. Pressing the <b>DOWN</b> key rewinds the tape. While AMS is ON, AMS FF/REW is performed. A search is made for the beginning of a track, then that track is played.</p> <p>While AMS is OFF, FF/REW is performed.</p> <p>During FF/REW operation, LCD indicator "▶" or "◀" blinks.</p> <p><b>(3) In CD changer mode</b></p> <p>If either of these keys is held down for about 0.5 seconds, search up/down is performed for as long as the key is held down. If the key is released within 0.5 seconds, 1-track up/down operation is performed. During track up/down operation, the LCD panel switches to the display of the track number. During search up/down operation, the panel switches to the time display.</p> <p><b>(4) When used to adjust the clock</b></p> <p>By pressing the <b>UP</b> or <b>DOWN</b> key in clock adjustment mode, the hour and minute digits of the clock can be adjusted.</p> <ul style="list-style-type: none"> <li> <p>• <b>Adjustment of the hour digits</b></p> <p>Each time the <b>UP</b> key is pressed, the hour digits of the clock are incremented by one. When the key is held down for about 0.5 seconds, the digits increment continuously every 0.2 seconds until the key is released.</p> <p>While the hour digits are being adjusted, the minute digits and second count value are not affected.</p> </li> <li> <p>• <b>Adjustment of the minute digits</b></p> <p>Each time the <b>DOWN</b> key is pressed, the minute digits of the clock are incremented by one. When the key is held down for about 0.5 seconds, the digits increment continuously every 0.1 seconds until the key is released. There is no carry-over to the hour digits.</p> <p>When clock adjustment is completed by pressing the <b>DISP/ADJ</b> key, the second digits are cleared to 0.</p> </li> </ul>

Momentary key	Description																																														
<b>VOL UP</b>	<p>These keys are used to adjust each electronic volume control function (volume, bass, treble, balance, fader) in electronic volume control mode.</p> <p>Either of the following two types of electronic volume controls can be selected.</p> <p>(1) TDA7313 (initial setting diode VOLSEL = 0)                      (2) TEA6320 (initial setting diode VOLSEL = 1)</p> <p><b>(1) TDA7313</b>                      TDA7313 can be used when initial setting diode VOLSEL = 0.</p> <p><b>(a) Volume</b>                      These keys are valid during normal/volume display.                      The electronic volume control function becomes valid when the key is pressed, and the volume is incremented or decremented in units of 1.25 [dB]. When the key is held down for about 0.5 seconds, the volume is successively incremented or decremented by 1.25 [dB] every 0.1 seconds, until the key is released.                      The initial value when the power is first applied is VOLUME 38 (-31.25 [dB]).</p> <table border="1" style="width: 100%; border-collapse: collapse;"> <tr> <td style="text-align: left;">Display (64 steps)</td> <td style="text-align: center;">VOL 0</td> <td style="text-align: center;">VOL 1</td> <td style="text-align: center;">VOL 2</td> <td style="text-align: center;">...</td> <td style="text-align: center;">VOL 62</td> <td style="text-align: center;">VOL 63</td> </tr> <tr> <td style="text-align: left;">Attenuation [dB]</td> <td style="text-align: center;">-78.75</td> <td style="text-align: center;">-77.50</td> <td style="text-align: center;">-76.25</td> <td style="text-align: center;">...</td> <td style="text-align: center;">-1.25</td> <td style="text-align: center;">0</td> </tr> </table> <p><b>(b) Bass</b>                      The bass control function is valid only in bass display mode.                      This function becomes valid as soon as either of these keys is pressed, and the bass is incremented or decremented in units of 2 [dB].                      When the key is held down for about 0.5 seconds, the bass is successively incremented or decremented at a rate of 2 [dB] every 0.3 seconds, until the key is released.                      The initial value when the power is first applied is BASS 0 (0 [dB]).</p> <table border="1" style="width: 100%; border-collapse: collapse;"> <tr> <td style="text-align: left;">Display (15 steps)</td> <td style="text-align: center;">BAS - 7</td> <td style="text-align: center;">BAS - 6</td> <td style="text-align: center;">...</td> <td style="text-align: center;">BAS 0</td> <td style="text-align: center;">...</td> <td style="text-align: center;">BAS + 6</td> <td style="text-align: center;">BAS + 7</td> </tr> <tr> <td style="text-align: left;">Attenuation [dB]</td> <td style="text-align: center;">-14</td> <td style="text-align: center;">-12</td> <td style="text-align: center;">...</td> <td style="text-align: center;">0</td> <td style="text-align: center;">...</td> <td style="text-align: center;">12</td> <td style="text-align: center;">14</td> </tr> </table> <p><b>(c) Treble</b>                      The treble control function is valid only in treble display mode.                      This function becomes valid as soon as either of these keys is pressed, and the treble is incremented or decremented in units of 2 [dB].                      When the key is held down for about 0.5 seconds, the treble is successively incremented or decremented every 0.3 seconds in units of 2 [dB], until the key is released.                      The initial value when the power is first applied is TRE 0 (0 [dB]).</p> <table border="1" style="width: 100%; border-collapse: collapse;"> <tr> <td style="text-align: left;">Display (15 steps)</td> <td style="text-align: center;">TRE - 7</td> <td style="text-align: center;">TRE - 6</td> <td style="text-align: center;">...</td> <td style="text-align: center;">TRE 0</td> <td style="text-align: center;">...</td> <td style="text-align: center;">TRE + 6</td> <td style="text-align: center;">TRE + 7</td> </tr> <tr> <td style="text-align: left;">Attenuation [dB]</td> <td style="text-align: center;">-14</td> <td style="text-align: center;">-12</td> <td style="text-align: center;">...</td> <td style="text-align: center;">0</td> <td style="text-align: center;">...</td> <td style="text-align: center;">12</td> <td style="text-align: center;">14</td> </tr> </table>	Display (64 steps)	VOL 0	VOL 1	VOL 2	...	VOL 62	VOL 63	Attenuation [dB]	-78.75	-77.50	-76.25	...	-1.25	0	Display (15 steps)	BAS - 7	BAS - 6	...	BAS 0	...	BAS + 6	BAS + 7	Attenuation [dB]	-14	-12	...	0	...	12	14	Display (15 steps)	TRE - 7	TRE - 6	...	TRE 0	...	TRE + 6	TRE + 7	Attenuation [dB]	-14	-12	...	0	...	12	14
Display (64 steps)		VOL 0	VOL 1	VOL 2	...	VOL 62	VOL 63																																								
Attenuation [dB]	-78.75	-77.50	-76.25	...	-1.25	0																																									
Display (15 steps)	BAS - 7	BAS - 6	...	BAS 0	...	BAS + 6	BAS + 7																																								
Attenuation [dB]	-14	-12	...	0	...	12	14																																								
Display (15 steps)	TRE - 7	TRE - 6	...	TRE 0	...	TRE + 6	TRE + 7																																								
Attenuation [dB]	-14	-12	...	0	...	12	14																																								
<b>VOL DOWN</b>																																															

Momentary key	Description																																																																																																																						
<table border="1" style="width: 100%; border-collapse: collapse;"> <tr> <td style="text-align: center; padding: 2px;">VOL UP</td> </tr> <tr> <td style="text-align: center; padding: 2px;">VOL DOWN</td> </tr> </table>	VOL UP	VOL DOWN	<p><b>(d) Balance</b></p> <p>The balance control function is valid only in balance display mode.</p> <p>This function becomes valid as soon as either of these keys is pressed. Pressing a key increments or decrements the balance by one step, respectively.</p> <p>When the key is held down for about 0.5 seconds, the balance is successively incremented or decremented at a rate of one step every 0.3 seconds. Incrementing or decrementing stops when BAL CNT is reached.</p> <p>The initial value when the power is first applied is BAL CNT (0 [dB]) for both the left and right.</p> <table border="1" style="width: 100%; border-collapse: collapse; text-align: center;"> <thead> <tr> <th colspan="2">Display (15 steps)</th> <th>BAL CNT</th> <th>BAL L1</th> <th>BAL L2</th> <th>BAL L3</th> <th>BAL L4</th> <th>BAL L5</th> <th>BAL L6</th> <th>BAL L7</th> </tr> </thead> <tbody> <tr> <td rowspan="2">Attenuation [dB]</td> <td>Right</td> <td>0</td> <td>-1.25</td> <td>-2.5</td> <td>-5.0</td> <td>-10.0</td> <td>-17.5</td> <td>-37.5</td> <td>MUTE</td> </tr> <tr> <td>Left</td> <td>0</td> <td>0</td> <td>0</td> <td>0</td> <td>0</td> <td>0</td> <td>0</td> <td>0</td> </tr> </tbody> </table> <table border="1" style="width: 100%; border-collapse: collapse; text-align: center;"> <thead> <tr> <th colspan="2">Display (15 steps)</th> <th>BAL R7</th> <th>BAL R6</th> <th>BAL R5</th> <th>BAL R4</th> <th>BAL R3</th> <th>BAL R2</th> <th>BAL R1</th> <th>BAL CNT</th> </tr> </thead> <tbody> <tr> <td rowspan="2">Attenuation [dB]</td> <td>Right</td> <td>0</td> <td>0</td> <td>0</td> <td>0</td> <td>0</td> <td>0</td> <td>0</td> <td>0</td> </tr> <tr> <td>Left</td> <td>MUTE</td> <td>-37.5</td> <td>-17.5</td> <td>-10.0</td> <td>-5.0</td> <td>-2.5</td> <td>-1.25</td> <td>0</td> </tr> </tbody> </table> <p><b>(e) Fader</b></p> <p>The fader can be adjusted when initial setting diode FAD = 0.</p> <p>This function is valid in fader display mode.</p> <p>This function becomes valid as soon as either of these keys is pressed, and the fader is incremented or decremented by one step.</p> <p>When the key is held down for about 0.5 seconds, the fader is successively incremented or decremented at a rate of one step every 0.3 seconds. Incrementing or decrementing stops when FAD CNT is reached.</p> <p>The initial value when the power is first applied is FAD CNT (0 [dB]) for both the front and rear.</p> <table border="1" style="width: 100%; border-collapse: collapse; text-align: center;"> <thead> <tr> <th colspan="2">Display (15 steps)</th> <th>FAD CNT</th> <th>FAD F1</th> <th>FAD F2</th> <th>FAD F3</th> <th>FAD F4</th> <th>FAD F5</th> <th>FAD F6</th> <th>FAD F7</th> </tr> </thead> <tbody> <tr> <td rowspan="2">Attenuation [dB]</td> <td>Front</td> <td>0</td> <td>0</td> <td>0</td> <td>0</td> <td>0</td> <td>0</td> <td>0</td> <td>0</td> </tr> <tr> <td>Rear</td> <td>0</td> <td>-1.25</td> <td>-2.5</td> <td>-5.0</td> <td>-10.0</td> <td>-17.5</td> <td>-37.5</td> <td>MUTE</td> </tr> </tbody> </table> <table border="1" style="width: 100%; border-collapse: collapse; text-align: center;"> <thead> <tr> <th colspan="2">Display (15 steps)</th> <th>FAD R7</th> <th>FAD R6</th> <th>FAD R5</th> <th>FAD R4</th> <th>FAD R3</th> <th>FAD R2</th> <th>FAD R1</th> <th>FAD CNT</th> </tr> </thead> <tbody> <tr> <td rowspan="2">Attenuation [dB]</td> <td>Front</td> <td>MUTE</td> <td>-37.5</td> <td>-17.5</td> <td>-10.0</td> <td>-5.0</td> <td>-2.5</td> <td>-1.25</td> <td>0</td> </tr> <tr> <td>Rear</td> <td>0</td> <td>0</td> <td>0</td> <td>0</td> <td>0</td> <td>0</td> <td>0</td> <td>0</td> </tr> </tbody> </table>	Display (15 steps)		BAL CNT	BAL L1	BAL L2	BAL L3	BAL L4	BAL L5	BAL L6	BAL L7	Attenuation [dB]	Right	0	-1.25	-2.5	-5.0	-10.0	-17.5	-37.5	MUTE	Left	0	0	0	0	0	0	0	0	Display (15 steps)		BAL R7	BAL R6	BAL R5	BAL R4	BAL R3	BAL R2	BAL R1	BAL CNT	Attenuation [dB]	Right	0	0	0	0	0	0	0	0	Left	MUTE	-37.5	-17.5	-10.0	-5.0	-2.5	-1.25	0	Display (15 steps)		FAD CNT	FAD F1	FAD F2	FAD F3	FAD F4	FAD F5	FAD F6	FAD F7	Attenuation [dB]	Front	0	0	0	0	0	0	0	0	Rear	0	-1.25	-2.5	-5.0	-10.0	-17.5	-37.5	MUTE	Display (15 steps)		FAD R7	FAD R6	FAD R5	FAD R4	FAD R3	FAD R2	FAD R1	FAD CNT	Attenuation [dB]	Front	MUTE	-37.5	-17.5	-10.0	-5.0	-2.5	-1.25	0	Rear	0	0	0	0	0	0	0	0
VOL UP																																																																																																																							
VOL DOWN																																																																																																																							
Display (15 steps)		BAL CNT	BAL L1	BAL L2	BAL L3	BAL L4	BAL L5	BAL L6	BAL L7																																																																																																														
Attenuation [dB]	Right	0	-1.25	-2.5	-5.0	-10.0	-17.5	-37.5	MUTE																																																																																																														
	Left	0	0	0	0	0	0	0	0																																																																																																														
Display (15 steps)		BAL R7	BAL R6	BAL R5	BAL R4	BAL R3	BAL R2	BAL R1	BAL CNT																																																																																																														
Attenuation [dB]	Right	0	0	0	0	0	0	0	0																																																																																																														
	Left	MUTE	-37.5	-17.5	-10.0	-5.0	-2.5	-1.25	0																																																																																																														
Display (15 steps)		FAD CNT	FAD F1	FAD F2	FAD F3	FAD F4	FAD F5	FAD F6	FAD F7																																																																																																														
Attenuation [dB]	Front	0	0	0	0	0	0	0	0																																																																																																														
	Rear	0	-1.25	-2.5	-5.0	-10.0	-17.5	-37.5	MUTE																																																																																																														
Display (15 steps)		FAD R7	FAD R6	FAD R5	FAD R4	FAD R3	FAD R2	FAD R1	FAD CNT																																																																																																														
Attenuation [dB]	Front	MUTE	-37.5	-17.5	-10.0	-5.0	-2.5	-1.25	0																																																																																																														
	Rear	0	0	0	0	0	0	0	0																																																																																																														

Momentary key	Description																																																
<table border="1" style="width: 100%; border-collapse: collapse;"> <tr> <td style="text-align: center; padding: 2px;">VOL UP</td> </tr> <tr> <td style="text-align: center; padding: 2px;">VOL DOWN</td> </tr> </table>	VOL UP	VOL DOWN	<p><b>(2) TEA6320</b> TEA6320 can be used when initial setting diode VOLSEL = 1.</p> <p><b>(a) Volume</b> These keys are valid during normal/volume display. The electronic volume control function becomes valid when the key is pressed, and the volume is incremented or decremented in units of 2 [dB]. When the key is held down for about 0.5 seconds, the volume is successively incremented or decremented at a rate of 2 [dB] every 0.1 seconds, until the key is released. The initial value when the power is first applied is VOL 22 (-24 [dB]).</p> <table border="1" style="width: 100%; border-collapse: collapse; text-align: center;"> <tr> <td style="width: 30%;">Display (41 steps)</td> <td>VOL 0</td> <td>VOL 1</td> <td>VOL 2</td> <td>...</td> <td>VOL 39</td> <td>VOL 40</td> </tr> <tr> <td>Attenuation [dB]</td> <td>MUTE</td> <td>-66</td> <td>-64</td> <td>...</td> <td>8</td> <td>10</td> </tr> </table> <p><b>(b) Bass</b> The bass control function is valid only in bass display mode. This function becomes valid as soon as either of these keys is pressed, and the bass is incremented or decremented in units of 3 [dB]. When the key is held down for about 0.5 seconds, the bass is successively incremented or decremented at a rate of 3 [dB] every 0.3 seconds, until the key is released. The initial value when the power is first applied is BAS 0 (0 [dB]).</p> <table border="1" style="width: 100%; border-collapse: collapse; text-align: center;"> <tr> <td style="width: 12.5%;">Display (9 steps)</td> <td>BAS - 4</td> <td>BAS - 3</td> <td>...</td> <td>BAS 0</td> <td>...</td> <td>BAS + 3</td> <td>BAS + 4</td> </tr> <tr> <td>Attenuation [dB]</td> <td>-12</td> <td>-9</td> <td>...</td> <td>0</td> <td>...</td> <td>9</td> <td>12</td> </tr> </table> <p><b>(c) Treble</b> The treble control function is valid only in treble display mode. This function becomes valid as soon as either of these keys is pressed, and the treble is incremented or decremented in units of 3 [dB]. When either key is held down for about 0.5 seconds, the treble is successively incremented or decremented at a rate of 3 [dB] every 0.3 seconds, until the key is released. The initial value when the power is first applied is TRE 0 (0 [dB]).</p> <table border="1" style="width: 100%; border-collapse: collapse; text-align: center;"> <tr> <td style="width: 12.5%;">Display (9 steps)</td> <td>TRE - 4</td> <td>TRE - 3</td> <td>...</td> <td>TRE 0</td> <td>...</td> <td>TRE + 3</td> <td>TRE + 4</td> </tr> <tr> <td>Attenuation [dB]</td> <td>-12</td> <td>-9</td> <td>...</td> <td>0</td> <td>...</td> <td>9</td> <td>12</td> </tr> </table>	Display (41 steps)	VOL 0	VOL 1	VOL 2	...	VOL 39	VOL 40	Attenuation [dB]	MUTE	-66	-64	...	8	10	Display (9 steps)	BAS - 4	BAS - 3	...	BAS 0	...	BAS + 3	BAS + 4	Attenuation [dB]	-12	-9	...	0	...	9	12	Display (9 steps)	TRE - 4	TRE - 3	...	TRE 0	...	TRE + 3	TRE + 4	Attenuation [dB]	-12	-9	...	0	...	9	12
VOL UP																																																	
VOL DOWN																																																	
Display (41 steps)	VOL 0	VOL 1	VOL 2	...	VOL 39	VOL 40																																											
Attenuation [dB]	MUTE	-66	-64	...	8	10																																											
Display (9 steps)	BAS - 4	BAS - 3	...	BAS 0	...	BAS + 3	BAS + 4																																										
Attenuation [dB]	-12	-9	...	0	...	9	12																																										
Display (9 steps)	TRE - 4	TRE - 3	...	TRE 0	...	TRE + 3	TRE + 4																																										
Attenuation [dB]	-12	-9	...	0	...	9	12																																										

Momentary key	Description																																																																																																																						
<table border="1" style="width: 100%; border-collapse: collapse;"> <tr> <td style="text-align: center; padding: 2px;">VOL UP</td> </tr> <tr> <td style="text-align: center; padding: 2px;">VOL DOWN</td> </tr> </table>	VOL UP	VOL DOWN	<p><b>(d) Balance</b></p> <p>The balance control function is valid only in balance display mode.</p> <p>This function becomes valid as soon as either of these keys is pressed, and the balance is incremented or decremented by one step.</p> <p>When a key is held down for about 0.5 seconds, the balance is successively incremented or decremented at a rate of one step every 0.3 seconds.</p> <p>The initial value when the power is first applied is BAL CNT (0 [dB]) for both the left and right.</p> <table border="1" style="width: 100%; border-collapse: collapse; text-align: center;"> <thead> <tr> <th colspan="2">Display (15 steps)</th> <th>BAL CNT</th> <th>BAL L1</th> <th>BAL L2</th> <th>BAL L3</th> <th>BAL L4</th> <th>BAL L5</th> <th>BAL L6</th> <th>BAL L7</th> </tr> </thead> <tbody> <tr> <td rowspan="2">Attenuation [dB]</td> <td>Right</td> <td>0</td> <td>-2</td> <td>-4</td> <td>-8</td> <td>-16</td> <td>-35</td> <td>-55</td> <td>MUTE</td> </tr> <tr> <td>Left</td> <td>0</td> <td>0</td> <td>0</td> <td>0</td> <td>0</td> <td>0</td> <td>0</td> <td>0</td> </tr> </tbody> </table> <table border="1" style="width: 100%; border-collapse: collapse; text-align: center;"> <thead> <tr> <th colspan="2">Display (15 steps)</th> <th>BAL R7</th> <th>BAL R6</th> <th>BAL R5</th> <th>BAL R4</th> <th>BAL R3</th> <th>BAL R2</th> <th>BAL R1</th> <th>BAL CNT</th> </tr> </thead> <tbody> <tr> <td rowspan="2">Attenuation [dB]</td> <td>Right</td> <td>0</td> <td>0</td> <td>0</td> <td>0</td> <td>0</td> <td>0</td> <td>0</td> <td>0</td> </tr> <tr> <td>Left</td> <td>MUTE</td> <td>-55</td> <td>-35</td> <td>-16</td> <td>-8</td> <td>-4</td> <td>-2</td> <td>0</td> </tr> </tbody> </table> <p><b>(e) Fader</b></p> <p>The fader can be adjusted when initial setting diode FAD = 0.</p> <p>This function is valid in fader display mode.</p> <p>This function becomes valid as soon as either of these keys is pressed, and the fader is incremented or decremented by one step.</p> <p>When either key is held down for about 0.5 seconds, the fader is successively incremented or decremented at a rate of one step every 0.3 seconds.</p> <p>The initial value when the power is first applied is FAD CNT (0 [dB]) for both the front and rear.</p> <table border="1" style="width: 100%; border-collapse: collapse; text-align: center;"> <thead> <tr> <th colspan="2">Display (15 steps)</th> <th>FAD CNT</th> <th>FAD F1</th> <th>FAD F2</th> <th>FAD F3</th> <th>FAD F4</th> <th>FAD F5</th> <th>FAD F6</th> <th>FAD F7</th> </tr> </thead> <tbody> <tr> <td rowspan="2">Attenuation [dB]</td> <td>Front</td> <td>0</td> <td>0</td> <td>0</td> <td>0</td> <td>0</td> <td>0</td> <td>0</td> <td>0</td> </tr> <tr> <td>Rear</td> <td>0</td> <td>-2</td> <td>-4</td> <td>-8</td> <td>-16</td> <td>-35</td> <td>-55</td> <td>MUTE</td> </tr> </tbody> </table> <table border="1" style="width: 100%; border-collapse: collapse; text-align: center;"> <thead> <tr> <th colspan="2">Display (15 steps)</th> <th>FAD R7</th> <th>FAD R6</th> <th>FAD R5</th> <th>FAD R4</th> <th>FAD R3</th> <th>FAD R2</th> <th>FAD R1</th> <th>FAD CNT</th> </tr> </thead> <tbody> <tr> <td rowspan="2">Attenuation [dB]</td> <td>Front</td> <td>MUTE</td> <td>-55</td> <td>-35</td> <td>-16</td> <td>-8</td> <td>-4</td> <td>-2</td> <td>0</td> </tr> <tr> <td>Rear</td> <td>0</td> <td>0</td> <td>0</td> <td>0</td> <td>0</td> <td>0</td> <td>0</td> <td>0</td> </tr> </tbody> </table>	Display (15 steps)		BAL CNT	BAL L1	BAL L2	BAL L3	BAL L4	BAL L5	BAL L6	BAL L7	Attenuation [dB]	Right	0	-2	-4	-8	-16	-35	-55	MUTE	Left	0	0	0	0	0	0	0	0	Display (15 steps)		BAL R7	BAL R6	BAL R5	BAL R4	BAL R3	BAL R2	BAL R1	BAL CNT	Attenuation [dB]	Right	0	0	0	0	0	0	0	0	Left	MUTE	-55	-35	-16	-8	-4	-2	0	Display (15 steps)		FAD CNT	FAD F1	FAD F2	FAD F3	FAD F4	FAD F5	FAD F6	FAD F7	Attenuation [dB]	Front	0	0	0	0	0	0	0	0	Rear	0	-2	-4	-8	-16	-35	-55	MUTE	Display (15 steps)		FAD R7	FAD R6	FAD R5	FAD R4	FAD R3	FAD R2	FAD R1	FAD CNT	Attenuation [dB]	Front	MUTE	-55	-35	-16	-8	-4	-2	0	Rear	0	0	0	0	0	0	0	0
VOL UP																																																																																																																							
VOL DOWN																																																																																																																							
Display (15 steps)		BAL CNT	BAL L1	BAL L2	BAL L3	BAL L4	BAL L5	BAL L6	BAL L7																																																																																																														
Attenuation [dB]	Right	0	-2	-4	-8	-16	-35	-55	MUTE																																																																																																														
	Left	0	0	0	0	0	0	0	0																																																																																																														
Display (15 steps)		BAL R7	BAL R6	BAL R5	BAL R4	BAL R3	BAL R2	BAL R1	BAL CNT																																																																																																														
Attenuation [dB]	Right	0	0	0	0	0	0	0	0																																																																																																														
	Left	MUTE	-55	-35	-16	-8	-4	-2	0																																																																																																														
Display (15 steps)		FAD CNT	FAD F1	FAD F2	FAD F3	FAD F4	FAD F5	FAD F6	FAD F7																																																																																																														
Attenuation [dB]	Front	0	0	0	0	0	0	0	0																																																																																																														
	Rear	0	-2	-4	-8	-16	-35	-55	MUTE																																																																																																														
Display (15 steps)		FAD R7	FAD R6	FAD R5	FAD R4	FAD R3	FAD R2	FAD R1	FAD CNT																																																																																																														
Attenuation [dB]	Front	MUTE	-55	-35	-16	-8	-4	-2	0																																																																																																														
	Rear	0	0	0	0	0	0	0	0																																																																																																														

### 3. RDS (RADIO DATA SYSTEM) FUNCTIONS

#### 3.1 Processing RDS Data

The  $\mu$ PD178016GC-051 incorporates an RDS data decoder section. Whether error correction is performed can be selected. If error correction is performed, the number of correction bits can be set to 1 to 5.

The  $\mu$ PD178016GC-051 uses the following eight types of data.

- (1) PI (Program Identification)
- (2) PS (Program Service Name)
- (3) PTY (Program Type)
- (4) AF (Alternative Frequency)
- (5) EON (Enhanced Other Network)
- (6) TP (Traffic Program Identification)
- (7) TA (Traffic Announcement Identification)
- (8) CT (Clock Time and Data)

##### 3.1.1 PI (Program Identification)

PI is used to identify the program being received.

##### 3.1.2 PS (Program Service Name)

PS is used for PS display on the LCD panel.

When identical PS data is read two or more times, the PS data is confirmed and displayed on the LCD panel.

About five seconds after the completion of tuning, the LCD panel changes to the PS display.

If PS data cannot be read within about five seconds, the LCD panel changes to the PS display at the point where PS data is read.

Once PS data has been read, if display switching is performed with the **DISP** key and TP/SK mode is turned on or off, the most-recently read PS data will be displayed about five seconds later, even if no other PS data is subsequently read.

##### 3.1.3 PTY (Program Type)

PTY is used to identify an alarm and display a program type.

If an alarm is read while the device is tuned to an RDS station, the device is switched to radio mode (if in tape/CD mode) and the  $\overline{\text{TA/DK}}$  pin (pin 18) goes low.

By pressing the **PTY** key, the program type can be displayed or a search for a given program type can be performed. (See **Section 2.5.3.**)

Program types are allocated as follows.

The character string enclosed in parentheses in the program type column is displayed in the 14-segment display area of the LCD panel when the corresponding program type is selected.

No.	Program type	
0, 16 to 30	No program type	(NONE)
1	News	(NEWS)
2	Current affairs	(AFFAIRES)
3	Information	(INFO)
4	Sports	(SPORT)
5	Education	(EDUCATE)
6	Drama	(DRAMA)
7	Culture	(CULTURE)
8	Science	(SCIENCE)
9	Variety	(VARIED)
10	Pop music	(POP M)
11	Rock music	(ROCK M)
12	M.O.R music	(M_O_R_M)
13	Light classic music	(LIGHT M)
14	Serious classic	(CLASSICS)
15	Other music	(OTHER M)
31	Alarm	(ALARM)

#### 3.1.4 RDS memory

The RDS memory of the  $\mu$ PD178016GC-051 consists of the following:

- **AF list**

PS codes, PI codes, and AF codes for 25 stations can be stored in each preset memory and each last channel. The AF list of the station currently being received can store the AF codes for 15 stations, in addition to the AF codes for the 25 stations mentioned above (giving a total of 40 stations). If, however, an AF operation, best station, or tuning operation other than an EON operation is performed, the AF codes for the 15 stations are cleared.

- **Pool memory**

PI codes for 15 stations can be stored. AF codes for 25 stations can be stored for each PI code.



**3.1.5 AF (Alternative Frequency)**

The same contents as those of the RDS station currently being received are used as the code of the frequency broadcast.

The read AF code is stored into RDS memory.

METHOD A and METHOD B are supported.

If the reception of the RDS station currently being received deteriorates in RDS mode, a search is made for a station having the same PI code and the frequency is changed (AF operation).

**(1) Judging the start of AF operation**

**(a) AF operation start condition**

The AF operation start conditions are listed below.

Signal meter reading / Decode state	Range pending	Range A	Range B	Range C
Number pending	o	o	o	×
40 or greater	o	o	o	×
35 or greater and less than 40	o	o	o	×
30 or greater and less than 35	o	Δ	o	×
15 or greater and less than 30	o	Δ	Δ	×
Less than 15	o	Δ	Δ	×

o: AF operation does not start.

Δ: Single-station/All-station AF operation starts. **Note**

×: All-station AF operation starts.

**Note** Select single-station or all-station AF operation by using initial setting diode AFALL.

**(b) Determining the signal meter reading range**

Determine the ranges (ranges A, B, and C, and range pending) of the signal meter readings by means of the following procedure:

- <1> Read the signal meter reading from the S • METER pin (pin 3) every 100 ms and calculate the average of the last five signal meter readings.
- <2> After the frequency has been changed, processing <3> below is not performed. The range remains pending until five signal meter readings have been obtained.
- <3> Determine the signal meter reading ranges illustrated below, based on the calculated average of the signal meter readings.

**Figure 3-1. Signal Meter Reading Ranges (where SMT\_A/B voltage > SMT\_B/C voltage)**

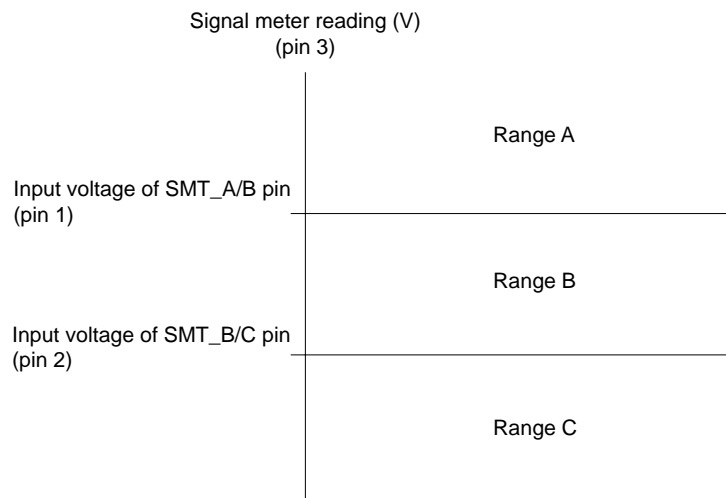

The boundary voltages between the adjacent ranges are those voltages input to the SMT\_A/B pin and SMT\_B/C pin when the power is first applied.

These voltages must be input so that SMT\_A/B voltage > SMT\_B/C voltage.

If SMT\_A/B voltage ≤ SMT\_B/C voltage, the SMT\_B/C voltage is invalid, so that the SMT\_A/B voltage is used as the boundary voltage.

In this case, two ranges, A and C, are used, as shown below.

**Figure 3-2. Signal Meter Reading Ranges (where SMT\_A/B voltage ≤ SMT\_B/C voltage)**

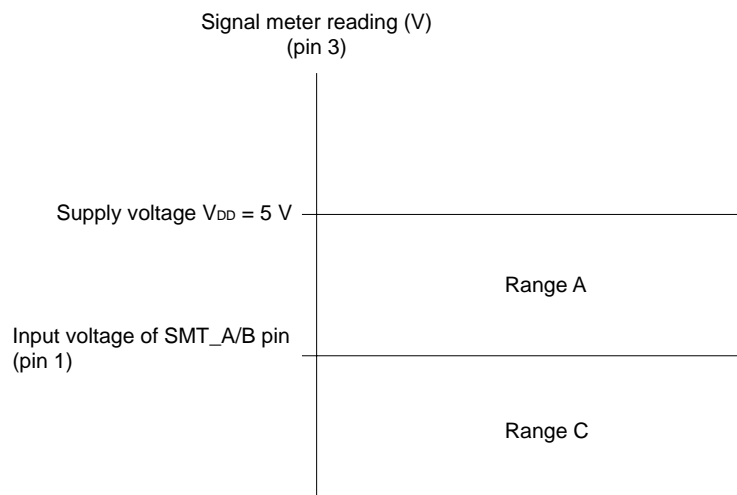

**(c) Determining the decode state**

- <1> Calculate the average of ten blocks, decoded in one second, and use this average as the decode state (number/number pending).
- <2> The number of blocks remains pending until ten items of data have been read after the frequency has been changed.
- <3> If the  $\overline{RDS}$  pin is high when the number of blocks is read, the number of blocks at that time will be 0.

(2) AF operation disable time/AF reception disable time

(a) AF operation disable time

This is the period during which AF operation is disabled.  
While the referenced disable timer is set, AF operation is not started.

(b) Setting of AF operation disable time

(i) When AF operation fails

The following AF operation disable time is set depending on the signal meter reading (S • M reading) ranges when the AF operation was started.

S • M reading range	Disable time
Range A	5 seconds
Range B	60 to 5 seconds <sup>Note</sup>
Range C	60 seconds

**Note** The AF operation disable time for range B is set as follows:

Range B is divided into 32 steps. The range into which the S • M reading falls is judged.

$$\text{Range} = \frac{(\text{S} \cdot \text{M reading} - \text{Input value of SMT\_B/C pin}) \times 32}{(\text{Input value of SMT\_A/B pin} - \text{Input value of SMT\_B/C pin})}$$

Division is performed with the result truncated below the decimal point.  
The disable time is set for each range as follows:

Range	Disable time (seconds)
31	60
30	58
29	56
⋮	Change of 2 seconds/range
10	18
9	16
8	14
7	12
6	11
5	10
4	9
3	8
2	7
1	6
0	5

**(ii) When changing the tunable frequency**

AF operation is disabled after the frequency has been changed until the reception state is stabilized.

Disable time
3 seconds

**(iii) When power is first applied**

AF operation is disabled until reception stabilizes.

Disable time
5 seconds

**(iv) If AF operation fails repeatedly in a tunnel**

If the S • M reading range changes from A to C, and if the AF operation has failed in range C, the system judges that the vehicle is currently in a tunnel.

If this judgment is made, AF operation is disabled depending on the number of times the operation has failed, so that AF operation is not retried frequently.

Disable time
(Number of successive failures - 1) × 60 seconds (9 minutes MAX.)

The number of successive failures is cleared in the following cases:

- When the tunable frequency is changed (except during AF operation/B.S./EON operation)
- If S • M reading range is not in range C
- If AF operation/B.S./EON operation is successful

**(v) If AF operation is repeatedly successful in the same region**

<1> If the AF operation (where S • M reading range is A) is successful in the decode state, the frequency at which the operation succeeded is recorded.

<2> If the number of stations for which the AF operation succeeded is three or less within one hour when <1> is repeatedly successful, it is judged that all the stations are suffering from reception abnormalities such as multipath.

However, this judgment is not made until <1> succeeds six times in a row.

<3> If a fault such as multipath occurs, the AF operation is immediately started even if the AF operation has been successful; therefore, the AF operation is disabled.

Disable time
10 seconds

<4> The frequency recorded in <1> is cleared in the following cases:

- When the tunable frequency is changed (except during AF operation/B.S./EON operation)
- When the AF operation succeeds in the S • M reading range (where the S • M reading range is B or C)

**(c) AF reception disable time**

This is the period during which the checking of a specific frequency during AF operation is disabled.

While the timer to be referenced is set, the frequency is not checked by the AF operation.

When the tunable frequency is changed (except during AF operation/B.S./EON operation), the AF reception disable time for all frequencies is cleared.

**(d) Setting AF reception disable time**

- (i) The disable time is set, as shown below, for that frequency at which the AF operation has failed for the cause of the failure of the operation.

Cause	Disable time
S • M reading	2 minutes
IF	4 minutes
PI once	7 minutes
PI two times	4 minutes
PI non-coincidence	12 minutes

- (ii) When the AF operation has been successful, the disable time is set as follows so that the original station is not restored to the received frequency immediately after the AF operation has been successful.

Disable time
1 minute

**(3) AF operation**

- **Flow of AF operation**

<1> All signal meter readings for those frequencies having the same priority are measured.

<2> The measured signal meter readings are sorted starting from the greatest reading.

<3> IF and PI are checked, in this order, starting from the greatest signal meter reading.

When PI coincides, the AF operation is stopped.

<4> If an AF station is not found in <1> through <3>, <1> through <3> are repeated for a lower priority. Where the priority is 1, however, when a frequency having priority 1 has been received, the signal meter reading, IF, and PI are successively checked, in this order.

If it is judged that no station is detected, the next frequency is measured.

**(a) Single-station AF operation**

One station is received and checked by turning on/off mute once, to check the original station.

After the original station has been received for one second, mute is detected (five seconds after if mute is not detected), and the next station is received and checked.

**Example** Where two stations have priority 1, three stations have priority 2, and two stations have priority 3 (see **Figure 3-3**)

<1> A station with priority 1 is received at I, and its signal meter reading, IF, and PI are checked, in this order.

<2> If an RDS station cannot be received in <1> above, the second station having priority 1 is received at II, and its signal meter reading, IF, and PI are checked, in this order.

- <3> If an RDS station with priority 1 cannot be received in <1> and <2> above, stations with priority 2 are received at III, IV, and V, and the signal meter reading of each station is measured.
- <4> The measured signal meter readings are sorted, starting from the greatest reading.
- <5> IF and PI are checked in the order of the sorted signal meter readings, at IV, VII, and VIII.  
If no station having priority 2 is found, and if the signal meter reading unacceptable in <3>, <6> is performed. If the signal meter reading is acceptable in <3>, the operation is completed when the AF operation next fails. Subsequently, <6> is performed by the next AF operation.
- <6> A station having priority 3 is checked in the same manner as a station having priority 2.
- <7> It is assumed that the AF operation has been successful when PI is judged as being acceptable, after which the AF operation is completed.

Figure 3-3. Single-Station AF Operation

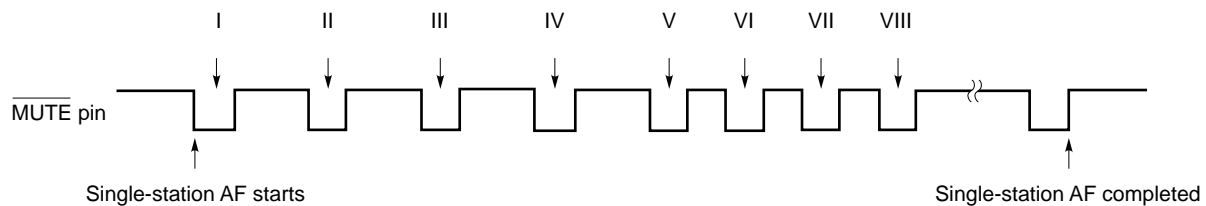

**(b) All-station AF operation**

Stations are sequentially received by turning mute on/off once, until a station for which reception is satisfactory is found.

All the frequencies in the AF list are checked. If a station for which reception is satisfactory cannot be found, it is assumed that AF operation has failed, and the AF operation is completed.

**Example** Where one station has priority 1, three stations have priority 2, and two stations have priority 3 (see Figure 3-4)

**(a)** <1> through <6> in the example of single-station AF operation are successively performed.

<7> It is assumed that the AF operation has been successful, and the AF operation is completed when PI is judged as being acceptable.

Figure 3-4. All-Station AF Operation

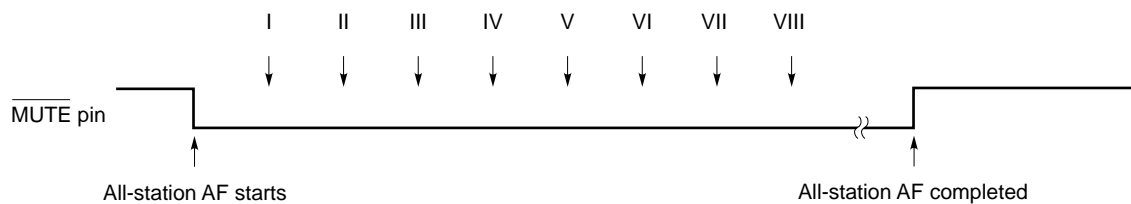

**(c) AF timing**

The frequencies in the AF list are received at the following timings.

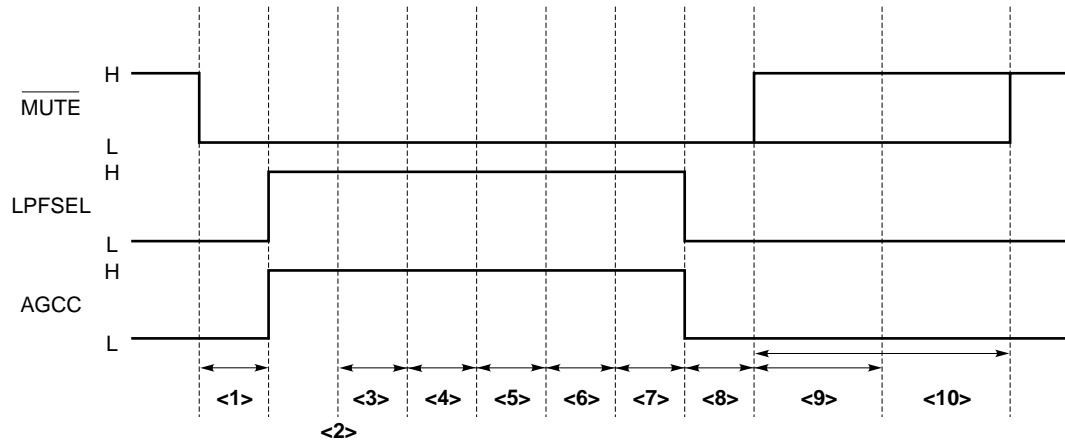

- <1> Preceding mute time (3 ms)
- <2> PLL set time
- <3> Lock wait time (40 ms MAX.)
- <4>  $\overline{SD}$  stabilization wait time (1 ms)
- <5> Signal meter reading measurement time
- <6> IF stabilization wait time (5 ms)
- <7> IF measurement time (4 ms, 40 ms MAX.)
- <8> Following mute time (3 ms) (Mute is cleared if initial setting diode NO\_PIM is jumpered.)
- <9> PI decode once wait time (400 ms MAX.)
- <10> PI decode two times wait time (800 ms MAX.)

**(4) Judgment of PI code**

**(a) Judgment of PI code when REGION mode is off**

When 16 bits coincide, the station is judged as being the same.

**(b) Judgment of PI code when REGION mode is on**

When 12 bits of the PI code, except the area cover code, coincide, the station is judged as being the same. If, however, the area cover code is 0 to 2, the station is judged as being the same when 16 bits coincide. For the UK market, however, 8 bits are used for judgment (the area cover code and the last 4 bits are not used).

**(c) AF operation for station in different REGION**

The following processing is performed so that a station in a different REGION is not easily selected during AF operation.

- <1> The signal meter reading at which the existence of a station is judged is changed between a station whose REGION coincides (or is unknown) and a station whose REGION is different, where the signal meter reading of the AF operation is judged.
- <2> The value at which the signal meter for a station in a different REGION is judged is set to 5 V (0FFH) when the tunable frequency is changed.
- <3> Each time the AF operation fails, the value at which the signal meter for a station in a different REGION is judged is decreased by 0.3125 V (10H). The minimum value is the voltage input to the SMT\_B/C pin, or +0.3125 V.

**(5) Identification of priority of METHOD**

**(a) Identification of method**

METHOD A is identified if the AF code in that portion for the AF list where the number of stations and AF codes are paired is the same three times in a row. METHOD B is identified if this AF code differs even once. This identification is made each time the tunable frequency has been changed.

**(b) Setting of priority by METHOD**

Each of the recorded AF codes is assigned a priority. The procedure for updating or searching the AF list is determined according to the priority.

The AF code is read with priority 5 until METHOD is identified.

All the AF codes are read with priority 2 with METHOD A.

METHOD B is set as follows:

Number of stations	AF1	AF1, AF2, TF condition		Priority	Priority
AF1	AF2	AF1 = TF	AF1 < AF2	2	High ↑ ↓ Low
		AF1 ≠ TF		3	
		AF1 = TF	AF1 > AF2	4	
		AF1 ≠ TF		5	

Priority 1 is set to the frequency at which a station is actually received.

**(c) Updating AF list**

• **Processing when AF code to be read is not in RDS memory**

An AF code is added to the beginning of the priority that is the same as that of the AF code to be read. If, as a result, the RDS memory capacity exceeds the rated value, the AF code having the lowest priority is deleted.

• **Processing when the AF code to be read is already in RDS memory**

If the priority of a previously read AF code is higher than that of the AF code to be read, the AF code is not read.

If the priority of the AF code to be read is higher than that of a previously read AF code, the previously read AF code is deleted and a new code is added.

**3.1.6 Best station**

The reception state is checked when an RDS station is received. If the reception is poor, a search is made for a station having the same PI code, and the frequency is changed. This operation is performed in RDS mode.

**(1) Best station start condition**

If the reception of the newly received frequency remains poor even after the following operations have been performed, best station is started (when signal meter reading < SMT\_B/C input voltage: +0.3125 V).

However, best station is not started when the FM tuner is turned on.

If a station for which the reception is good cannot be found as a result of best station, PI seek is started.

- Radio mode selection
- Band switching
- Preset memory calling



**(2) Operation of best station**

- (a) One station is received at a time in steps <1> through <5>, below, starting from the beginning of the AF list, and the signal meter reading for each station is measured.
- <1> Mute is turned on, and the LPFSEL pin (pin 27) is driven high after the completion of the preceding mute time (3 ms).
  - <2> A channel on the AF list is received.
  - <3> The signal meter reading is measured using the S • METER pin (pin 3), 1 ms after the station has been locked.  
If the station is not locked after 40 ms, and if the signal meter reading is less than that when best station was started, or if it is less than the best station start condition, <5> is performed.
  - <4> The input signal meter reading is stored into RAM.
  - <5> The above operation is repeated starting from <2> if there is another station to be checked.
- (b) PI check is sequentially performed starting from the greatest of the signal meter readings measured in (a).
- <1> A channel on the AF list is received.
  - <2> The signal meter reading is measured by using the S • METER pin, 1 ms after the station has been locked.  
If the station is not locked after 40 ms, and if the signal meter reading is less than that when best station was started, or less than the best station start condition, <8> is performed.
  - <3> IF is measured 5 ms after if initial setting diode FM SD/IF is jumpered.  
If IF is not within the permissible range, <8> is performed.
  - <4> The LPFSEL pin is driven low.
  - <5> Reading PI is awaited.  
If decoding is not performed once within 400 ms, <8> is performed.  
If decoding is not performed two times within 800 ms, <8> is performed.
  - <6> The read PI code is checked for coincidence.  
For an explanation of how to check the PI code, see (4) in **Section 3.1.5**.
  - <7> If the PI code coincides, that station is received, and best station is completed.
  - <8> If there is another station to be checked, the above operation is repeated starting from <1>.
  - <9> If no station is found after all the frequencies on the AF list have been searched, best station is terminated, and PI seek is performed.

**3.1.7 Automatic station selection**

A search is made for a station by using the RDS data during seek.

The following four types of seek operations can be performed.

- (1) RDS seek
- (2) PI seek
- (3) PTY seek
- (4) TP/SK seek

**(1) RDS seek**

- RDS seek is performed if seek is performed in RDS mode.
- Only an RDS station is selected from the stations that are judged to have a station.
- RDS seek is terminated if the following condition is satisfied.
  - (a) If a PI code is read within 650 ms after the existence of a station has been judged.

**(2) PI seek**

- PI seek is performed if best station has failed in RDS mode.
- Only an RDS station having the same PI code as that of the RDS station being received before best station operation is started is selected from the stations that are judged to have a station.
- PI seek is terminated if all the following conditions are satisfied.
  - (a) If a PI code is read within 650 ms after the existence of a station has been judged.
  - (b) If the PI code is compared and coincides.
- If an RDS station having the same PI code is not found after the band has been subject to one round of searching, the frequency to which the system was tuned before the operation was started is received.

**(3) PTY seek**

- PTY seek is performed when seek is performed in PTY mode.
- Only an RDS station from which the same PTY code as PTY displayed before the start of PTY seek is selected from the stations that are judged to have a station.
- PTY seek is completed if all the following conditions are satisfied.
  - (a) If a PTY code is read within 650 ms after the existence of a station has been judged.
  - (b) If the PTY code is compared and coincides.
- If an RDS station having the same PI code is not found after the band has been subject to one round of searching, the frequency to which the system was tuned before the operation was started is received.

**(4) TP/SK seek**

- TP/SK seek is performed if seek is performed in TP/SK mode.
- Only an RDS station from which TP = 1 is read is selected from all the stations that are judged to have a station.
- TP/SK seek is terminated if all the following conditions are satisfied.
  - (a) If TP code is read within 650 ms after existence of a station has been judged.
  - (b) TP code = 1
- If RDS mode is off, however, the station for which the  $\overline{SK}$  pin (pin 65) is low is also selected. If the TP code is read within 1 150 ms of the existence of a station having been judged, TP/SK seek is terminated.

**3.1.8 Emergency broadcasting reception**

When emergency broadcasting is started, radio mode is selected, and the emergency broadcast is received. This section explains how emergency broadcasting is received.

**(1) If TP/SK mode is off in CD changer/tape mode**

- <1> The frequencies of the most-recently selected band, from the minimum frequency to the maximum frequency, are searched, and that RDS station for which reception is strongest is selected. When the AM band was selected last, FM1 is received.
- <2> Search is performed again if the state in which the PTY code cannot be decoded persists for 30 seconds when <1> is being received.
- <3> If the PTY code indicates emergency broadcasting (PTY = 31) in the state in which the PTY code can be decoded, radio mode is selected, and the "ALARM" indicator blinks.
- <4> Upon the completion of emergency broadcasting, the original sound is restored (when the PTY code has been changed, or 30 seconds after the PTY code can no longer be read).

**(2) If TP/SK mode is on**

- <1> The most-recently selected channel of the most-recently selected band is received. When the AM band was selected last, FM1 is received.
- <2> If the PTY code indicates emergency broadcasting (PTY = 31) in the state in which the PTY code can be decoded, radio mode is selected, and the "ALARM" indicator blinks.

- <3> Upon the completion of emergency broadcasting, the original sound is restored (when the PTY code has been changed, or 30 seconds after the PTY code can no longer be read).

### 3.1.9 EON (Enhanced Other Network)

This data is used as the code for the information of an RDS station other than the network of the received RDS station.

The EON operation is explained next.

- (1) When TA of group 14B = 1 (ON), and when the same list as PI (ON) exists in the pool memory, the EON operation is performed.
  - <1> Mute is turned on, the LPFSEL pin (pin 27) is driven high after the preceding mute time (3 ms), and the channel of the pool memory is received.
  - <2> The signal meter reading is measured by using the S • METER pin 1 ms after the station has been locked. If the station is not locked after 40 ms, and if the signal meter reading is less than the voltage being input to the SMT\_B/C pin (+0.3125 V), <4> is performed.
  - <3> The measured signal meter reading is stored into RAM.
  - <4> The above operation is repeated, starting from <1>, if there is another station to be checked.
  
- (2) PI is checked sequentially, starting from the greatest of the measured signal meter readings.
  - <1> The channel of the pool memory is received.
  - <2> After a station has been locked, IF is measured after 5 ms if initial setting diode FM IF/SD is jumpered. If IF is not within the permissible range, <6> is performed.
  - <3> The reading of PI is awaited.
    - If decoding is not performed once within 400 ms, <6> is performed.
    - If decoding is not performed two times within 800 ms, <6> is performed.
  - <4> The read PI code is checked for the coincidence of 16 bits.
  - <5> If the PI code coincides, the receiving of a station is awaited for four seconds until both TP and TA are set to 1. If a station can be received, that station is received, and the EON operation is completed.
  - <6> The above operation is repeated, starting from <1>, if there is another station to be checked.
  - <7> The EON operation is completed if no station is found after all the frequencies of the pool memory have been searched.

### 3.1.10 TP (Traffic Program Identification), TA (Traffic Announcement Identification)

TP and TA are used to identify the broadcasting state of traffic information.

Traffic information is received in TP/SK mode.

If the state, in which TP or TA of the RDS station being received is not 1, lasts for four seconds, TP/SK seek up is started (when initial setting diode RETUNE = 1).

If RDS mode is off, however, TP/SK seek up is started if the state, in which the  $\overline{SK}$  pin (pin 65) is not low, lasts for four seconds.

#### (1) Traffic information standby → traffic information reception

The state is changed from traffic information standby to traffic information reception when EON is received with TP = TA = 1 or TA = 1 (ON).

If RDS mode is off, however, the state is also changed when the  $\overline{SK}$  and  $\overline{DK}$  pins (pin 65 and 64) go low.

- **Operation when TP = TA = 1 (or when both the  $\overline{\text{SK}}$  and  $\overline{\text{DK}}$  pins are low)**

- In radio mode
  - The  $\overline{\text{SK MUTE}}$  pin (pin 19) is driven high.
  - The  $\overline{\text{TA/DK}}$  pin (pin 18) is driven low.
- In CD changer/tape mode
  - Radio mode is selected.
- Common
  - If the volume is less than the initial value, it is automatically changed to the initial value.

- **Operation when TA = 1 (ON)**

The RDS station having the PI (ON) code is searched in RDS memory and received.

If TP = TA = 1 cannot be read within four seconds of the station being received, the original station is restored and received.

Operation when TP = TA = 1 is read from an RDS station with PI (ON)

- In radio mode
  - The  $\overline{\text{SK MUTE}}$  pin is driven high.
  - The  $\overline{\text{TA/DK}}$  pin is driven low.
- In CD changer/tape mode
  - Radio mode is selected.
- Common
  - If the volume is less than the initial value, it is automatically changed to the initial value.

**(2) Traffic information reception → traffic information standby**

The state is changed from traffic information reception to traffic information standby if both TP and TA are not 1, or if TP and TA cannot be decoded for 30 seconds.

The original station is received if the traffic information reception state is set with TA = 1 (ON).

- In radio mode
  - The  $\overline{\text{SK MUTE}}$  pin is driven low.
  - The  $\overline{\text{TA/DK}}$  pin is driven high.
- In CD changer/tape mode
  - The original sound is restored.
- Common
  - If the volume was automatically changed when the traffic information was received, it is restored to its original level.
  - If the volume was changed manually, however, it is not restored to its original level.

**3.1.11 CT (Clock Time and Data)**

CT is used to adjust the clock.

The time transmitted by a broadcast is the Coordinated Universal Time (UTC) as specified in the CCIR recommendations. It is converted to the local time before being used as clock data.

By inputting time announcement information, the internal clock of the  $\mu$ PD178016GC-051 is corrected using the broadcast time information.

When initial setting diode CTADJ is set to 1, the clock is constantly being corrected by the input of broadcast time information. Whenever the clock is corrected, the seconds are reset to zero.

Note that correction is made based on the broadcast time information, even when the clock is being adjusted using the time adjustment keys.

Whether to enable adjustment of the clock using the time adjustment keys is specified using initial setting diodes NOCLK and CTADJ.

4. SELECTOR CONTROL

4.1 Timing of Transition from POWER ON to OFF, and Vice Versa, with the POWER Key

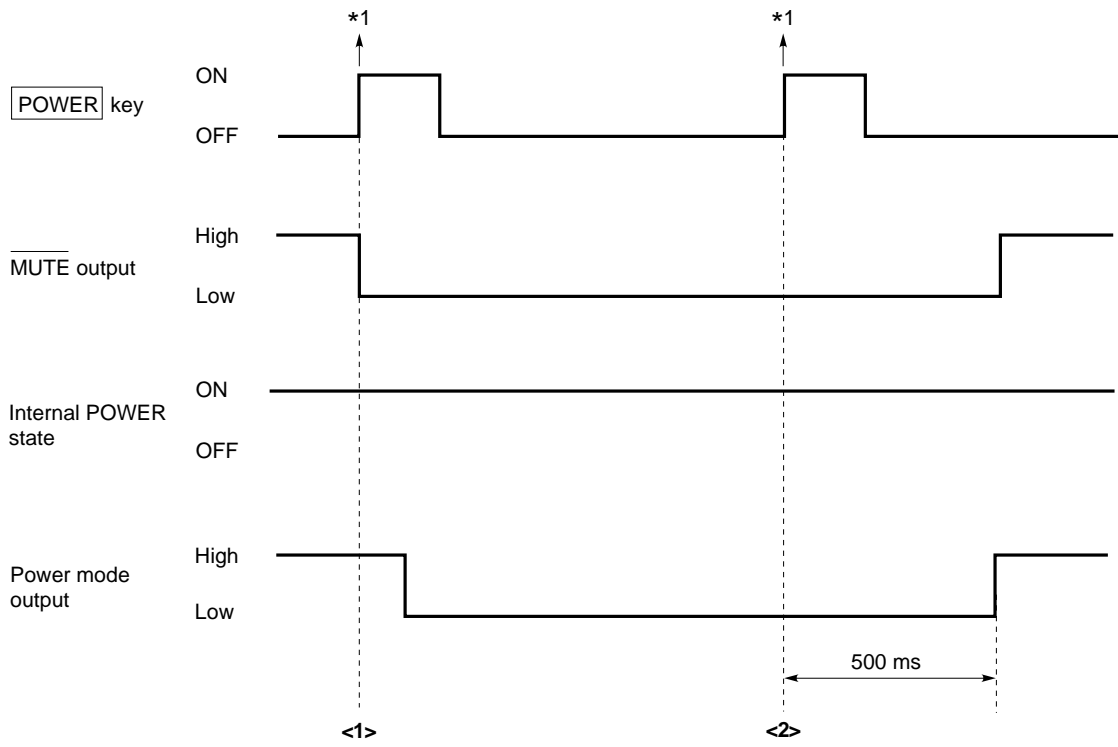

<1> Port setting, radio OFF, and serial communication interruption at POWER OFF

<2> Radio ON

\*1 Timing at which a change in key entry is detected (not including chattering removal time)

4.2 Timing of Transition from POWER ON to OFF, and Vice Versa, with the Detachable Panel

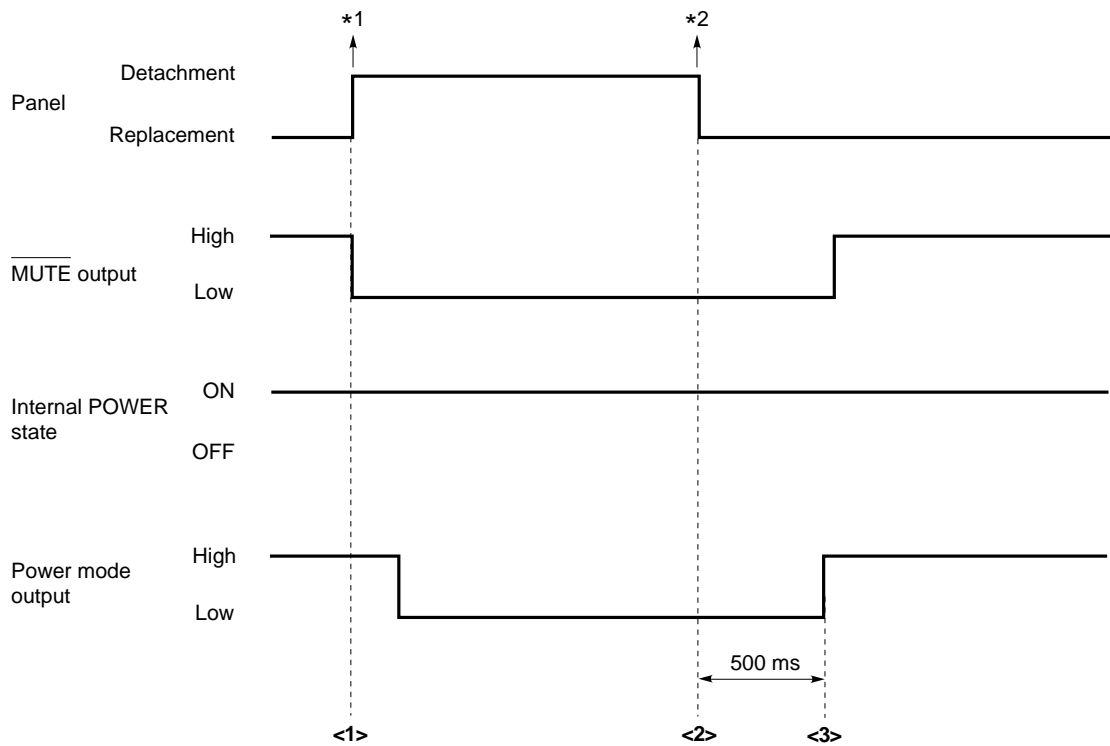

- <1> Port setting, radio OFF, and serial communication interruption at POWER OFF
- <2> Radio ON
- <3> Start of audio source mode and start of serial communication
- \*1 Timing at which panel detachment is detected (not including chattering removal time)
- \*2 Timing at which panel mounting is detected (not including chattering removal time)

4.3 Timing of Audio Mode Switching

Example Radio to TAPE

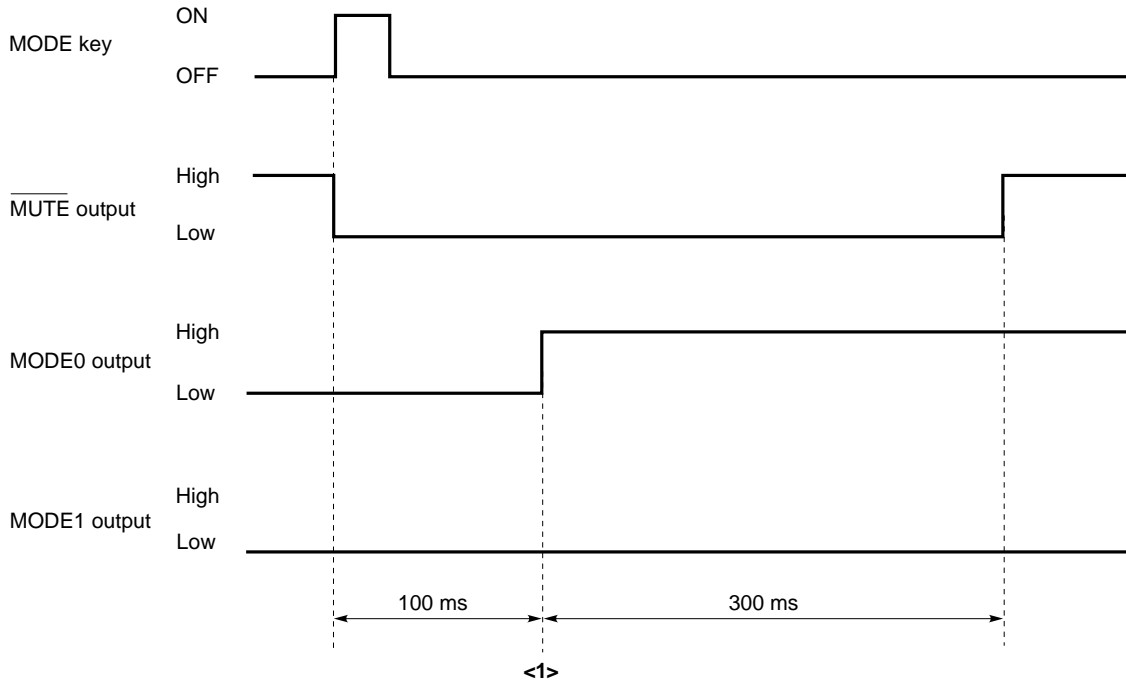

<1> Display switching

Example TAPE to CD changer

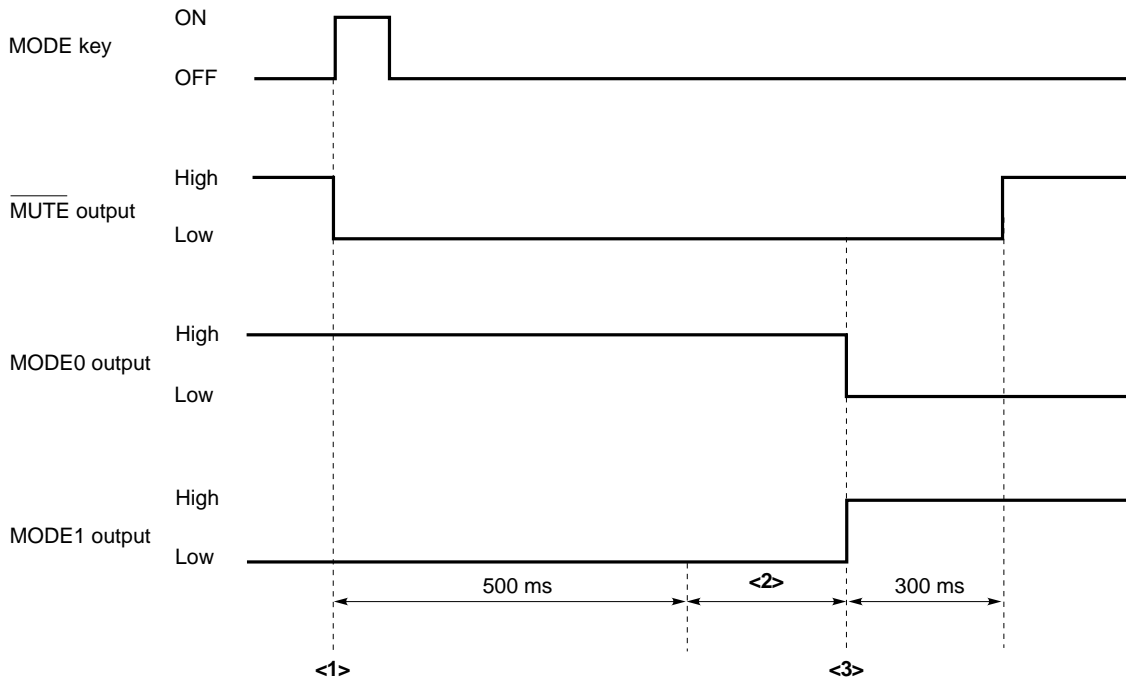

<1> CD changer ON

<2> One second to confirm that the CD changer is connected (the radio will be connected when a CD changer is not installed).

<3> Display switching

4.4 Timing of Audio Mode Switching while Traffic Information Is Being Broadcast (in TP/SK Mode)

Example TAPE to traffic information

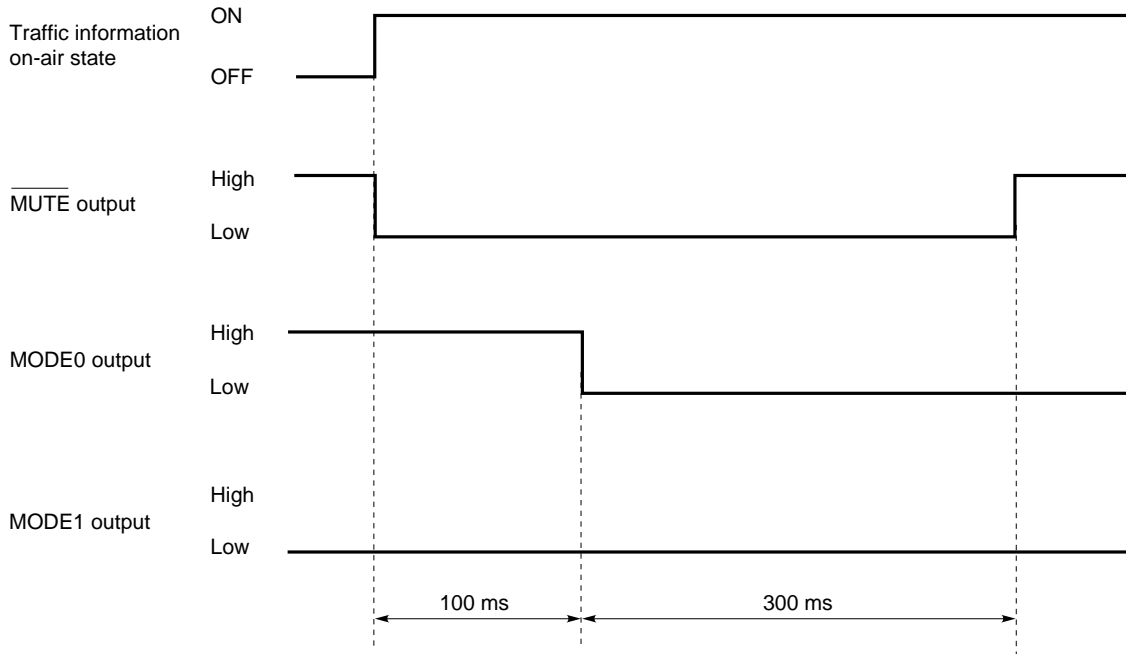

**Caution** If traffic information is being broadcast in radio mode,  $\overline{\text{MUTE}}$  output is not performed (because the audio mode does not change).



4.5 Detection of Front Panel Detachment

(1) Panel state detection timing

When the high level state of the panel input signal is detected ten times in a row, the panel is assumed to have been detached (see <1>). The time required to assume that the panel has been detached is  $10 \text{ ms} \times 10 + \text{Time required for sensing} = 100 \text{ ms}$  or longer but less than 110 ms.

The timing at which the replacement of the front panel is detected is the same as above.

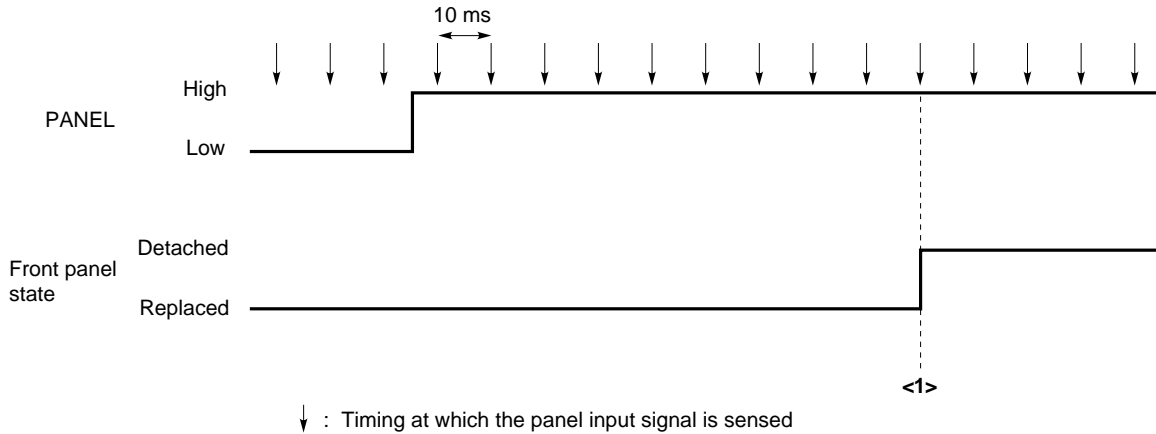

(2) Operations performed when front panel detachment and replacement are detected

When the front panel is judged to have been detached, the power is turned off irrespective of the setting of the **POWER** key.

When the panel is judged as being installed, the setting of the **POWER** key is checked and, if it is judged to be OK, the power is turned on.

(See **Sections 4.1** and **4.2** for details on power state transitions.)

4.6 Timing of Audio Mode Switching Timing with PTY Alarm (PTY = 31)

**Example** CD changer to PTY alarm

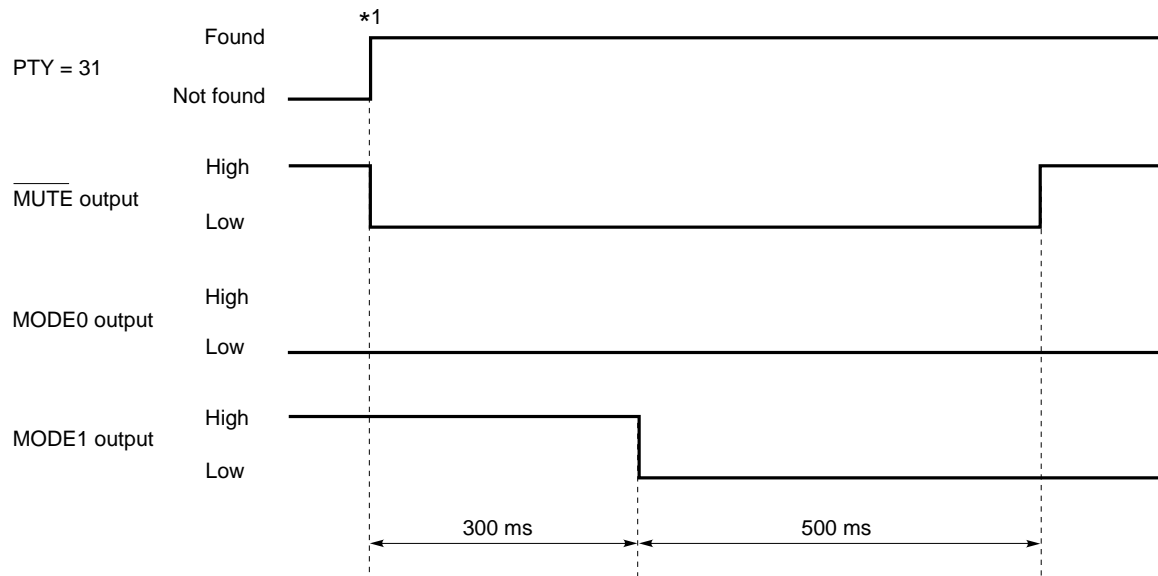

*\*1* Timing at which PTY = 31 is detected (not including the time required to confirm two matches)

**Caution** If a PTY alarm is generated in radio mode, MUTE output is not performed because the audio mode does not change.

5. LCD PANEL

5.1 Configuration of the LCD Panel

An example of the configuration of the LCD panel is shown below.

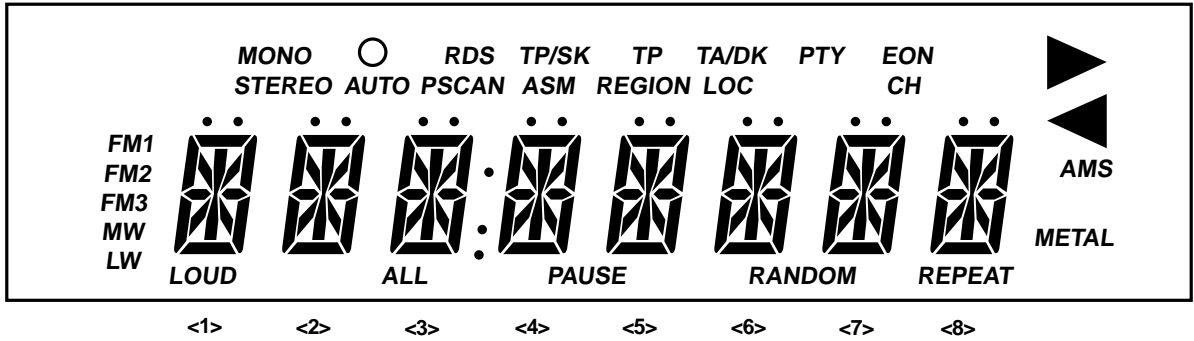

5.2 Assignment of LCD Pins

Table 5-1 lists the assignments of the LCD pins of the μPD16431A.

<1> to <8> indicate the column positions in the 14-segment display area. "a" through "n" indicate the following 14 segments.

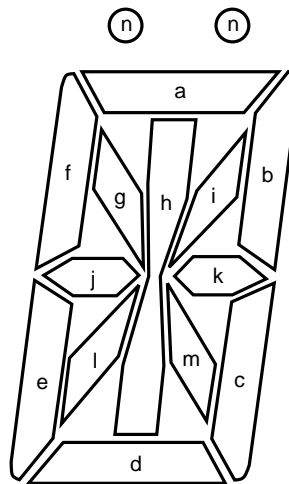

Table 5-1. Assignment of LCD Pins (1/2)

Segment \ Common	COM0 (21)	COM1 (22)	COM2 (23)	COM3 (24)
SEG1 (25)	FM3	MW	LW	
SEG2 (26)				
SEG3 (27)	FM2	<1> f	<1> e	FM1
SEG4 (28)	<1> g	<1> j	<1> l	
SEG5 (29)	<1> a	<1> h	<1> d	LOUD
SEG6 (30)	<1> i	<1> k	<1> m	
SEG7 (31)	<1> n	<1> b	<1> c	
SEG8 (32)				
SEG9 (33)	STEREO	<2> f	<2> e	MONO
SEG10 (34)	<2> g	<2> j	<2> l	
SEG11 (35)	<2> a	<2> h	<2> d	ALL
SEG12 (36)	<2> i	<2> k	<2> m	
SEG13 (37)	<2> n	<2> b	<2> c	○
SEG14 (38)				
SEG15 (39)	AUTO	<3> f	<3> e	RDS
SEG16 (40)	<3> g	<3> j	<3> l	
SEG17 (41)	<3> a	<3> h	<3> d	PAUSE
SEG18 (42)	<3> i	<3> k	<3> m	
SEG19 (43)	<3> n	<3> b	<3> c	.
SEG20 (44)				
SEG21 (45)	PSCAN	<4> f	<4> e	:
SEG22 (46)	<4> g	<4> j	<4> l	
SEG23 (47)	<4> a	<4> h	<4> d	RANDOM
SEG24 (48)	<4> i	<4> k	<4> m	
SEG25 (49)	<4> n	<4> b	<4> c	
SEG26 (50)				

- Remarks** 1. The digit in parentheses indicates a pin number of the μPD16431A.  
 2. Blank: Not used

Table 5-1. Assignment of LCD Pins (2/2)

Segment \ Common	COM0 (21)	COM1 (22)	COM2 (23)	COM3 (24)
SEG27 (51)	ASM	<5> f	<5> e	TP/SK
SEG28 (52)	<5> g	<5> j	<5> l	
SEG29 (53)	<5> a	<5> h	<5> d	
SEG30 (54)	<5> i	<5> k	<5> m	
SEG31 (55)	<5> n	<5> b	<5> c	TP
SEG32 (56)				
SEG33 (57)	REGION	<6> f	<6> e	◀
SEG34 (58)	<6> g	<6> j	<6> l	
SEG35 (59)	<6> a	<6> h	<6> d	
SEG36 (60)	<6> i	<6> k	<6> m	
SEG37 (61)	<6> n	<6> b	<6> c	TA/DK
SEG38 (62)				
SEG39 (63)	LOC	<7> f	<7> e	▶
SEG40 (64)	<7> g	<7> j	<7> l	
SEG41 (65)	<7> a	<7> h	<7> d	REPEAT
SEG42 (66)	<7> i	<7> k	<7> m	
SEG43 (67)	<7> n	<7> b	<7> c	PTY
SEG44 (68)				
SEG45 (69)		<8> f	<8> e	EON
SEG46 (70)	<8> g	<8> j	<8> l	
SEG47 (71)	<8> a	<8> h	<8> d	
SEG48 (72)	<8> i	<8> k	<8> m	
SEG49 (73)	<8> n	<8> b	<8> c	CH
SEG50 (74)				
SEG51 (75)			METAL	AMS

- Remarks** 1. The digit in parentheses indicates a pin number of the μPD16431A.  
 2. Blank: Not used

5.3 LCD Panel Displays

Display	Description
ALL	This indication appears during disc introduction scan, disc repeat, and disc random operations in CD changer mode.
AMS	Indicates that the system is in auto music search mode.
ASM	This indication appears during auto-storage operation in radio mode.
AUTO	This indication appears in radio mode and auto mode.
CH	This indicator indicates the channel of a preset memory number. The display turns on when a channel number is displayed in the 14-segment display area.
EON	Indicates that the station currently being received broadcasts traffic information. The display turns on when a TA signal is detected with other RDS stations received while an RDS station is being received.
FM1 FM2 FM3 LW MW	Indicates the radio band being received.
LOC	This indication appears in radio mode with LOCAL set.
LOUD	This indication appears in loudness mode.
METAL	The display turns on when METAL tape is inserted in tape mode.
MONO	The display turns on when the FM band is received in radio mode and forced MONO mode.
PAUSE	This indication appears during pause in CD changer mode.
PSCAN	This indication appears during preset memory scan operation in radio mode.
PTY	This indication appears during PTY search from PTY display while an FM band is being received in radio mode.
RANDOM	This indication appears in disc random mode and random mode in CD changer mode.
RDS	This indication appears in RDS mode when an FM band is being received in radio mode.
REGION	This indication appears in REGION mode in radio mode.
REPEAT	This indication appears in repeat mode and disc repeat mode in CD changer mode.
STEREO	The display turns on when STEREO pin goes low while an FM band is being received in radio mode. However, always turns off if forced MONO mode is on.
TA/DK	Indicates that the station currently being received is broadcasting traffic information. The display turns on when the TA signal of an RDS station or the DK signal of a VF station is detected.
TP	Indicates that the station currently being received broadcasts traffic information. The display turns on when the TP signal of an RDS station or the SK signal of a VF station is detected.
TP/SK	The display turns on when an FM band is being received in TP/SK mode.
○	Indicates that the station currently being received is an RDS station. The display turns on when the PI signal of an RDS station is read while an FM band is being received.
▶	Indicates the tape running direction.

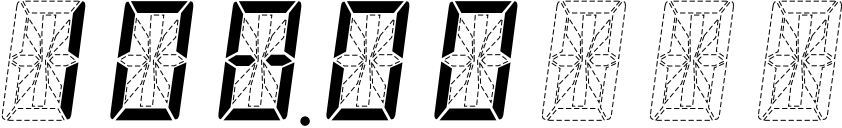
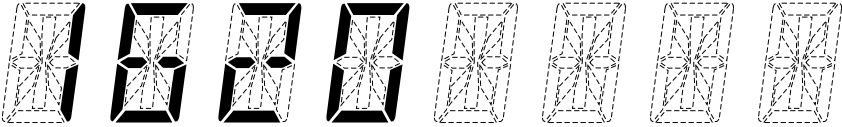
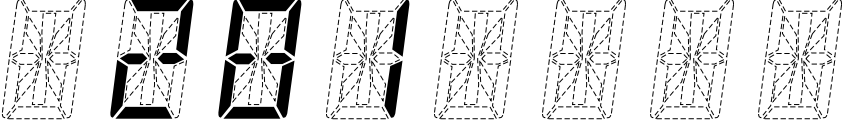
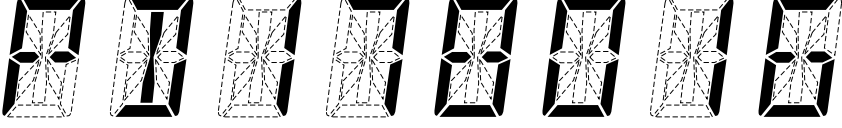
Display	Description
14-segment display area	<p>Displays the following:</p> <ul style="list-style-type: none"> <li>(1) Received frequency</li> <li>(2) PS (Program Service Name)</li> <li>(3) Clock</li> <li>(4) Tape</li> <li>(5) CD changer</li> <li>(6) Electronic volume control</li> </ul> <p><b>(1) Received frequency display</b></p> <p>&lt;1&gt; In the FM band (108.00 MHz)</p>  <p>&lt;2&gt; In the MW band (1 620 kHz)</p>  <p>&lt;3&gt; In the LW band (281 kHz)</p>  <p><b>(2) PS display (if PS data is μPD178016)</b></p> 

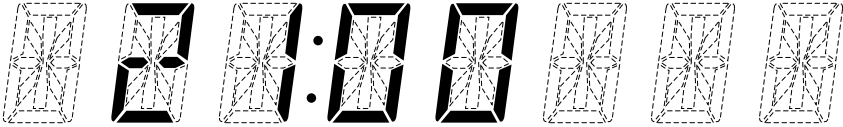
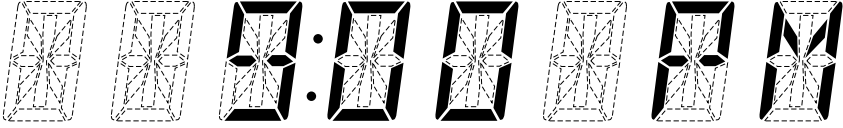
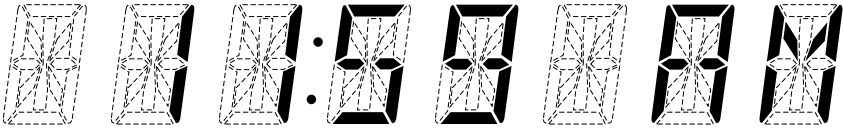
Display	Description
<p>14-segment display area</p>	<p><b>(3) Clock display</b></p> <p>&lt;1&gt; 24-hour display (21:00)</p>  <p>&lt;2&gt; 12-hour display (9:00 p.m.)</p>  <p>&lt;3&gt; 12-hour display (11:59 a.m.)</p> 

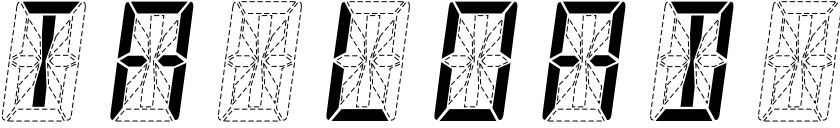
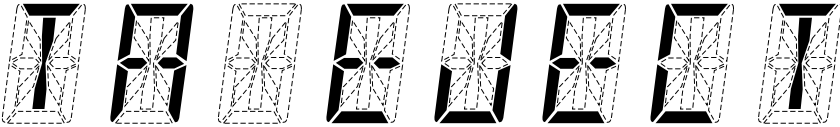
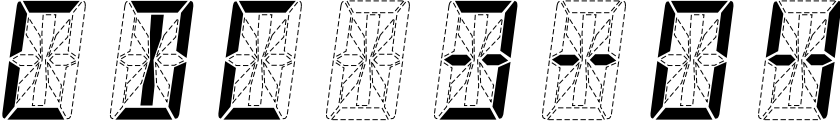
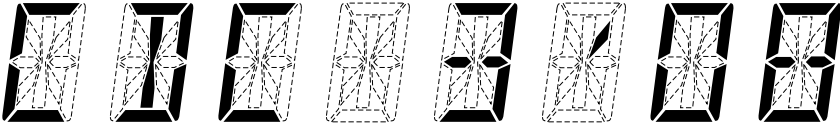
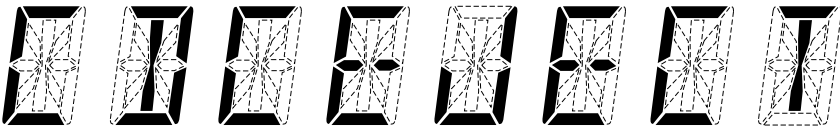

Display	Description
<p>14-segment display area</p>	<p><b>(4) Tape display</b></p> <p>&lt;1&gt; PLAY</p>  <p>&lt;2&gt; LOAD</p>  <p>&lt;3&gt; EJECT</p> 
<p>14-segment display area</p>	<p><b>(5) CD changer display</b></p> <p>&lt;1&gt; Track display (disc 3, track 4)</p>  <p>&lt;2&gt; Display of elapsed time (3 minutes 8 seconds)</p>  <p>&lt;3&gt; EJECT display</p> 

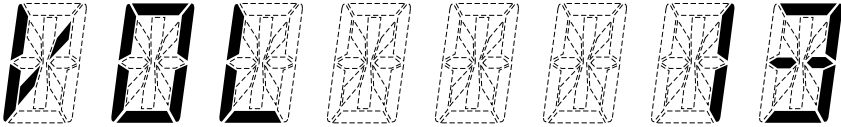
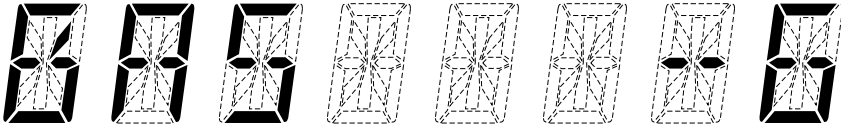
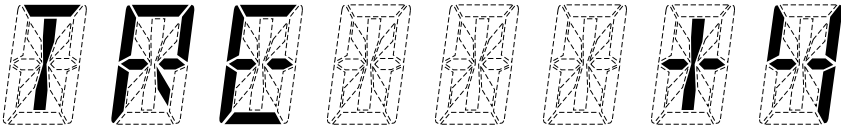
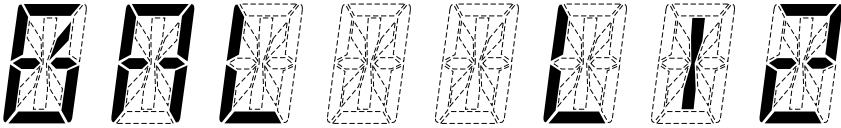
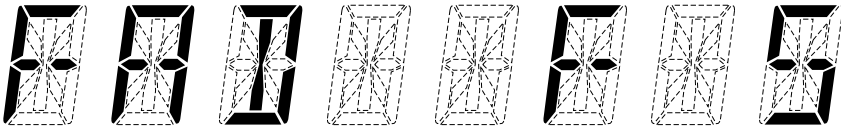
Display	Description
14-segment display area	<p data-bbox="337 210 727 237"><b>(6) Electronic volume control display</b></p> <p data-bbox="371 273 727 300">&lt;1&gt; Volume display (VOLUME 13)</p>  <p data-bbox="371 514 673 541">&lt;2&gt; BASS display (BASS -6)</p>  <p data-bbox="371 756 717 783">&lt;3&gt; TREBLE display (TREBLE 4)</p>  <p data-bbox="371 997 789 1024">&lt;4&gt; BALANCE display (BALANCE L 12)</p>  <p data-bbox="371 1239 714 1266">&lt;5&gt; FADER display (FADER F 5)</p> 

**6. DESCRIPTION OF μPD16431A CONTROL**

The μPD178016GC-051 uses the μPD16431A to control the LCD display.

The connection of the μPD178016GC-051 to the μPD16431A is illustrated below.

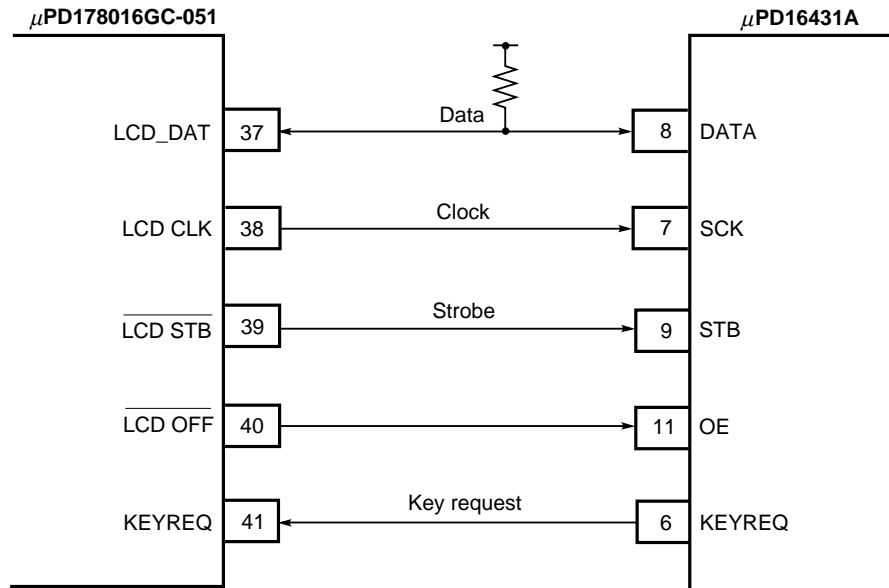

**6.1 Key Scan**

Key scan using the μPD16431A is performed as follows:

**(1) Detecting a pressed key**

The controller judges the state of the KEYREQ pin (pin 6) of the μPD16431A every 20 ms.

When the KEYREQ pin is high, it is assumed that a key is being pressed. Noise elimination (chattering elimination) based on three consecutive matches is applied.

When noise elimination is performed correctly, the key code is read with serial reception.

Key data is received within 20 ms while a key is held down (the KEYREQ pin is high).

**(2) Detecting the release of a key**

When a key is released, the level of the KEYREQ pin of the μPD16431A goes from high to low. The pin is scanned every 20 ms and, if the low level is detected three times in a row, it is judged that the key has been released.

### 6.2 Initial Data Output

The μPD178016GC-051 transfers the next initialization data to the μPD16431A about 500 ms after the level of LCD OFF (pin 40) changes from low to high.

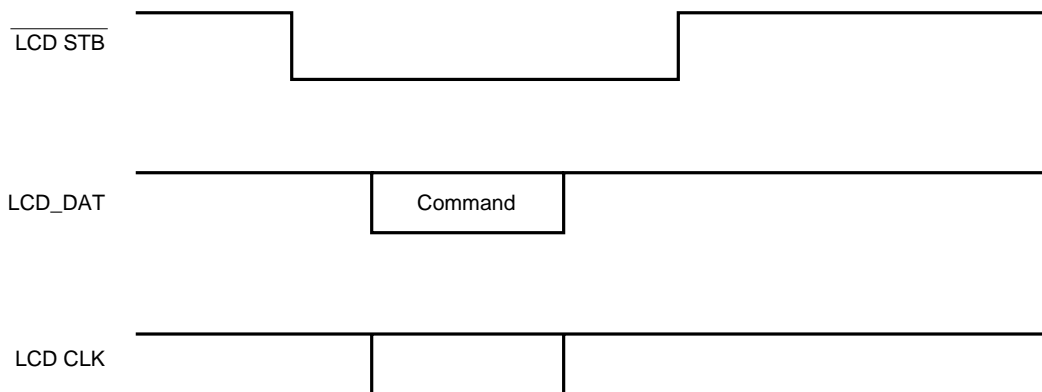

Command : 00001000 (initialization command)

1/4 duty, (fosc/512) /4, internal drive voltage, master, and normal operation are initialized.

### 6.3 Display Data Output

The output of display data to the μPD16431A is shown below.

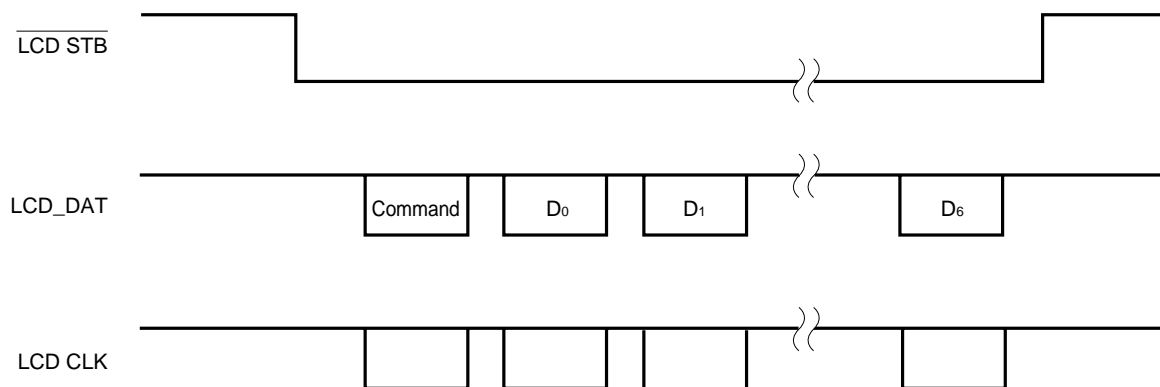

Command : 10000100 (status command (at COM1 output))

: 10001100 (status command (at COM2 output))

: 10010100 (status command (at COM3 output))

: 10011100 (status command (at COM4 output))

D<sub>0</sub> to D<sub>6</sub> : 00000000 (display data)

|  
11111111

The above display output is repeated four times when sending display data.

**6.4 Key Data Input/Output**

The input and output of key data to and from the μPD16431A are shown below.

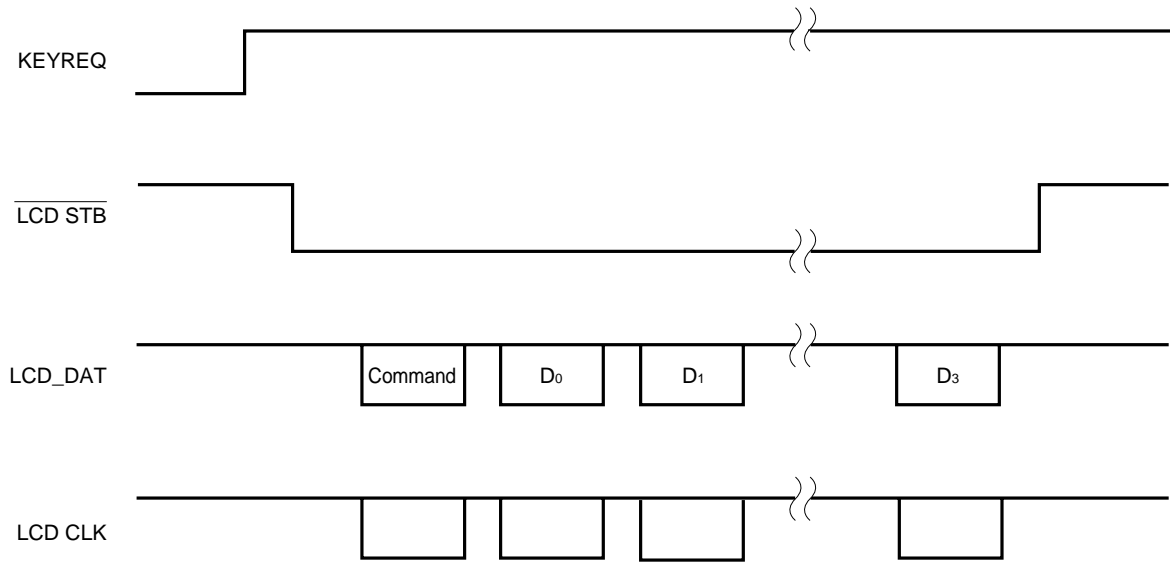

Command : 10000101 (status command (key data readout))

D<sub>0</sub> to D<sub>3</sub> : 00000000 (display data)

|  
11111111

After the status command is send, key data is read from the LCD\_DAT pin.

## 7. REMOTE CONTROL

The μPD6121G IC is used for sending a remote-controller signal. This IC uses a custom code, which must be set correctly to enable the control of the μPD178016GC-051 using a remote-controller signal.

The μPD178016GC-051 is operated with custom code 8604H. To set this code, connect diodes and pull-up resistors on the key matrix of the transmitter IC (μPD6121G). (See **Section 7.4.**)

### 7.1 Remote Control Key Configuration (When the μPD6121G Is Used)

Input pin (pin number) Output pin (pin number)	KI <sub>0</sub> (1)	KI <sub>1</sub> (2)	KI <sub>2</sub> (3)	KI <sub>3</sub> (4)
KI/O <sub>0</sub> (19)	M1	M2	M3	M4
KI/O <sub>1</sub> (18)	M5	M6	DOWN	UP
KI/O <sub>2</sub> (17)	PSCAN/ASM	RDS/REGION	TP/SK	PTY
KI/O <sub>3</sub> (16)	BAND	CDC	TAPE	DISP/ADJ
KI/O <sub>4</sub> (15)	MONO/LOC	VOL DOWN	VOL UP	SEL/LOUD
KI/O <sub>5</sub> (14)	AUTO	INTRO	REPEAT	RANDOM/AMS
KI/O <sub>6</sub> (13)	—	—	—	—
KI/O <sub>7</sub> (12)	POWER	—	—	EJECT

—: Undefined

**7.2 Description of the Remote Control Keys**

The functions of the remote control keys are the same as those of the μPD178016GC-051 momentary keys.

**7.3 Remote Control Data Codes**

- When a single key is pressed

Remote control key	Data code							
	D0	D1	D2	D3	D4	D5	D6	D7
M1	0	0	0	0	0	0	0	0
M2	1	0	0	0	0	0	0	0
M3	0	1	0	0	0	0	0	0
M4	1	1	0	0	0	0	0	0
M5	0	0	1	0	0	0	0	0
M6	1	0	1	0	0	0	0	0
DOWN	0	1	1	0	0	0	0	0
UP	1	1	1	0	0	0	0	0
PSCAN/ASM	0	0	0	1	0	0	0	0
RDS/REGION	1	0	0	1	0	0	0	0
TP/SK	0	1	0	1	0	0	0	0
PTY	1	1	0	1	0	0	0	0
BAND	0	0	1	1	0	0	0	0
CDC	1	0	1	1	0	0	0	0
TAPE	0	1	1	1	0	0	0	0
DISP/ADJ	1	1	1	1	0	0	0	0

Remote control key	Data code							
	D0	D1	D2	D3	D4	D5	D6	D7
MONO/LOC	0	0	0	0	1	0	0	0
VOL DOWN	1	0	0	0	1	0	0	0
VOL UP	0	1	0	0	1	0	0	0
SEL/LOUD	1	1	0	0	1	0	0	0
AUTO	0	0	1	0	1	0	0	0
INTRO	1	0	1	0	1	0	0	0
REPEAT	0	1	1	0	1	0	0	0
RANDOM/AMS	1	1	1	0	1	0	0	0
—	0	0	0	1	1	0	0	0
—	1	0	0	1	1	0	0	0
—	0	1	0	1	1	0	0	0
—	1	1	0	1	1	0	0	0
POWER	0	0	1	1	1	0	0	0
—	1	0	1	1	1	0	0	0
—	0	1	1	1	1	0	0	0
EJECT	1	1	1	1	1	0	0	0

—: Undefined

7.4 Sample Remote Control Circuit Using the  $\mu$ PD6121G-002

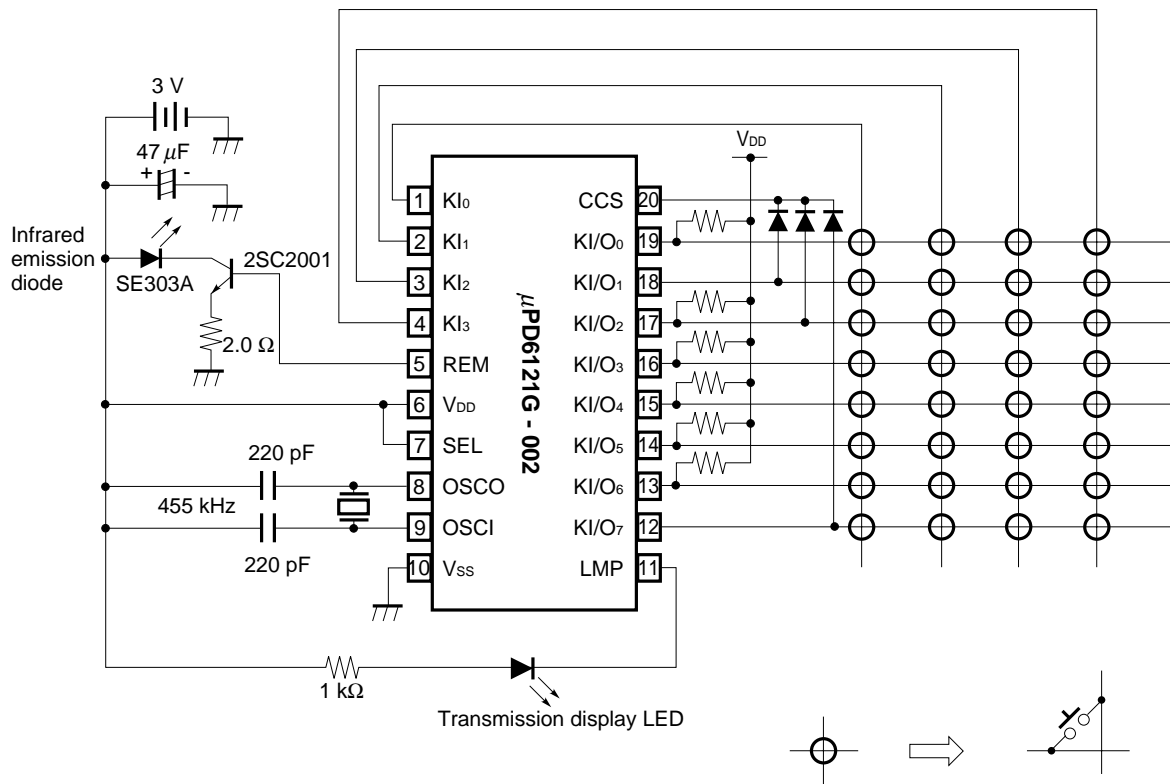

7.5 Sample Remote Control Preampifier Using the  $\mu$ PC2800HA

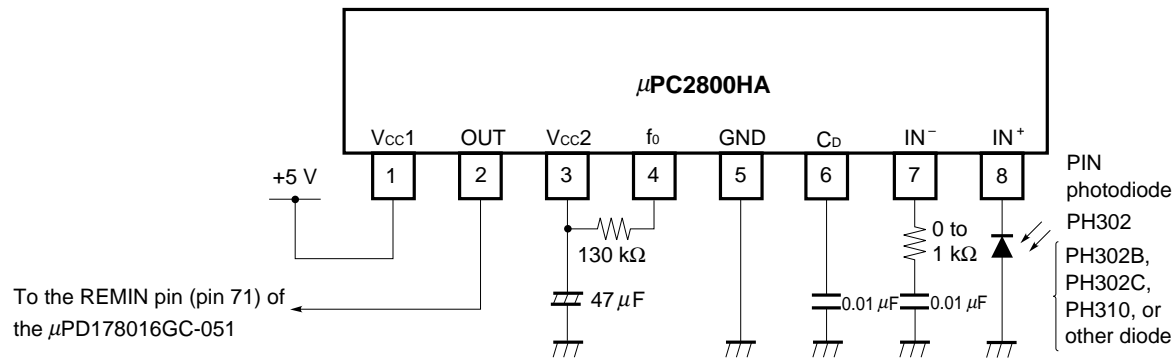



## 8. DESCRIPTION OF CD CHANGER CONTROL

The  $\mu$ PD178016GC-051 is provided with CD changer control functions.

The pin connection between the  $\mu$ PD178016GC-051 and CD changer is illustrated below.

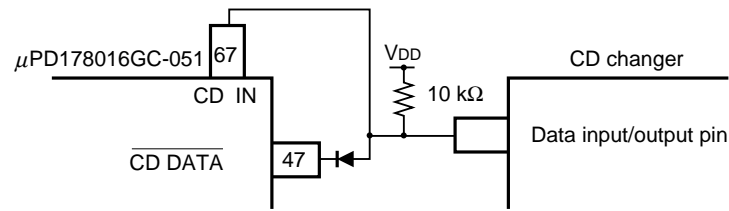

To transmit data between the  $\mu$ PD178016GC-051 and CD changer, use the CD changer data input pin (pin 67) and the CD changer data output pin (pin 47).

The following CD changer control functions are supported:

- Power-on
- Power-off
- Disc selection
- Play/pause
- Track up/down
- Search up/down
- Repeat
- Introduction scan
- Random

For details of each control function, see **Chapter 2**.

## 9. ELECTRONIC VOLUME CONTROLS

### 9.1 Electronic Volume Controls

The μPD178016GC-051 uses an electronic volume control IC for audio control and selection. It supports two types of electronic volume control ICs, the TDA7313 and TEA6320. Initial setting diode VOLSEL is set depending on which electronic volume control IC is being used.

The following electronic volume controls are supported:

Function	Electronic volume control IC	
	TDA7313	TEA6320
Volume	0 to 63 steps	0 to 40 steps
Bass	-7 to +7 steps	-4 to +4 steps
Treble	-7 to +7 steps	-4 to +4 steps
Balance	L7 to R7 steps	L7 to R7 steps
Fader	R7 to F7 steps	R7 to F7 steps
Loudness	On/off	On/off

See the description of the **VOL UP** and **VOL DOWN** keys for an explanation of how each adjustment is made.

### 9.2 Initial Values of Electronic Volume Controls

When power is first applied to the μPD178016GC-051, the initial values of the electronic volume controls are as listed below.

Function	Initial value	
	TDA7313	TEA6320
Volume	38 steps	22 steps
Bass	0 step	
Treble	0 step	
Balance	0 step (CNT)	
Fader	0 step (CNT)	
Loudness	Off	

## 10. MUTE OUTPUT TIMING CHART

This chapter shows the mute output timings.

<1> through <17> in the timing charts on the following pages indicate the time required for each processing, as follows:

- <1> Key on chattering wait time
- <2> Key off chattering wait time
- <3> Key valid wait time
- <4> Preceding mute time
- <5> Division ratio setting time
- <6> PLL lock wait time
- <7> SD stabilization wait time
- <8> IF measurement time
- <9> RDS data decode wait time (150 ms)
- <10> PI code read wait time
- <11> TP code read wait time
- <12> PI/TP code read wait time
- <13> SK read wait time
- <14> PTY read wait time
- <15> Following mute time
- <16> Scan wait time
- <17> Power-on processing time

10.1 Manual Up/Down

10.1.1 1-channel up/down

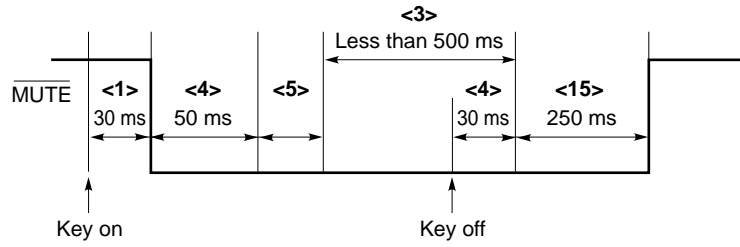

Time <15> is 550 ms at band edge.

10.1.2 Successive up/down

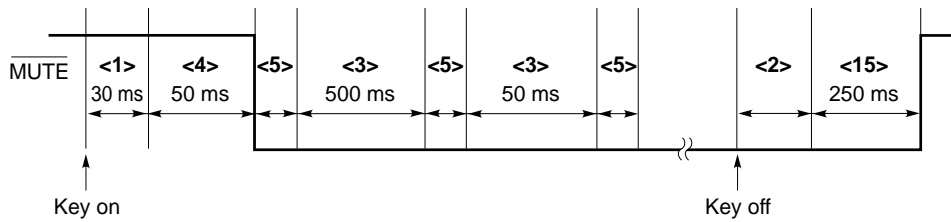

Time <3> is 600 ms and time <15> is 550 ms at band edge.

10.2 Auto Up/Down

10.2.1 Normal seek

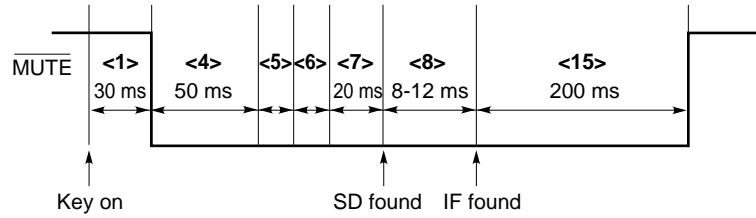

However, time <7> is 600 ms and time <15> is 500 ms if a band edge is detected in the middle.  
 Time <8> is 16 to 24 ms in the AM band.  
 If an error occurs in <7> or <8>, the next frequency is received (<5>).

10.2.2 RDS seek

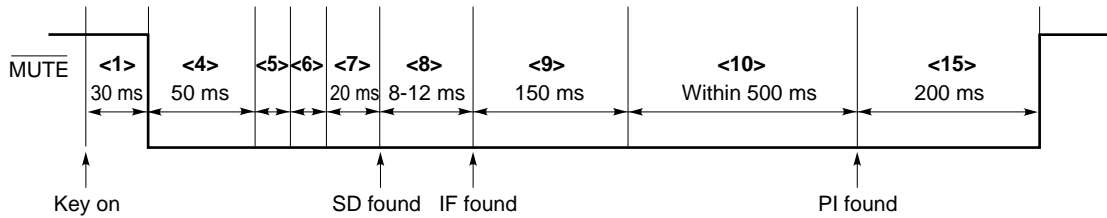

However, time <7> is 600 ms and time <15> is 500 ms if a band edge is detected in the middle.  
 If an error occurs in <7>, <8>, or <10>, the next frequency is received (<5>).

10.2.3 PI seek

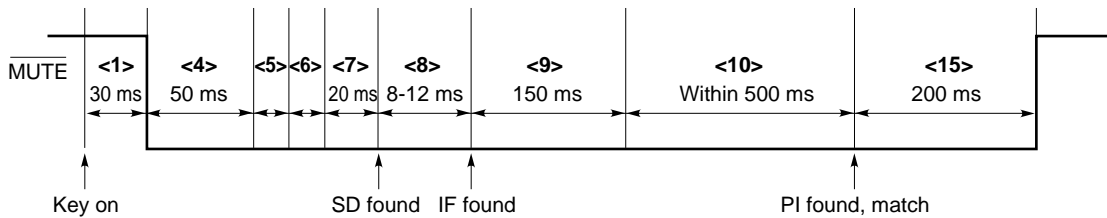

However, time <7> is 600 ms and time <15> is 500 ms if a band edge is detected in the middle.  
 If an error occurs in <7>, <8>, or <10>, the next frequency is received (<5>).

10.2.4 TP seek

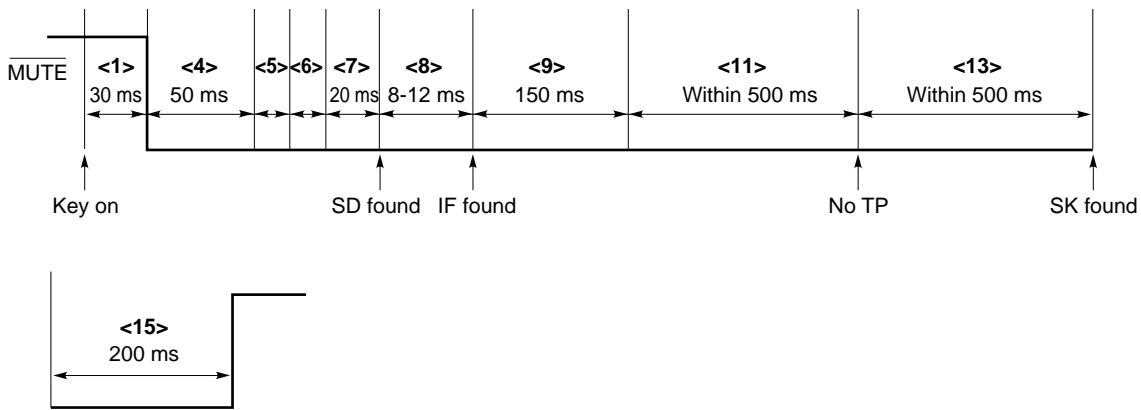

However, time <7> is 600 ms and time <15> is 500 ms if a band edge is detected in the middle.

If an error occurs in <7>, <8>, or <13>, the next frequency is received (<5>).

If PI/TP is found in <11>, <15> is performed.

<13> is not performed in RDS mode. If an error occurs in <11>, the next frequency is received. If no error occurs, <15> is performed.

10.2.5 PTY seek

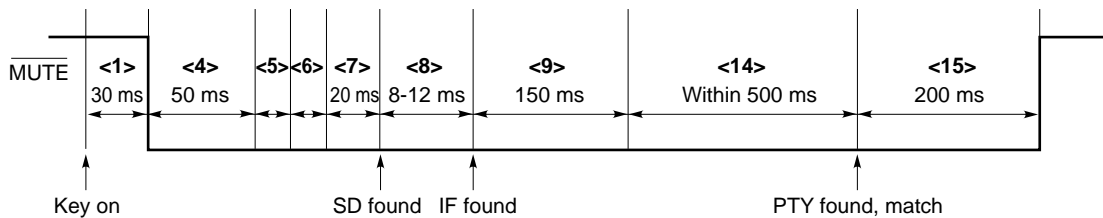

However, time <7> is 600 ms and time <15> is 500 ms if a band edge is detected in the middle.

If an error occurs in <7>, <8>, or <14>, the next frequency is received (<5>).

10.3 Preset Memory Calling

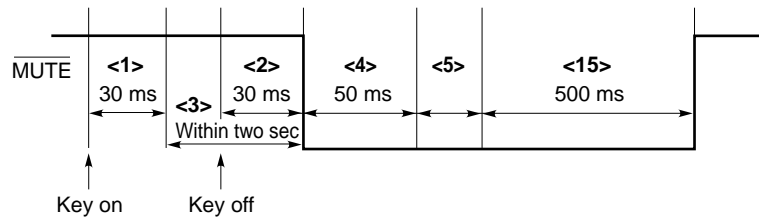

10.4 Preset Memory Scan

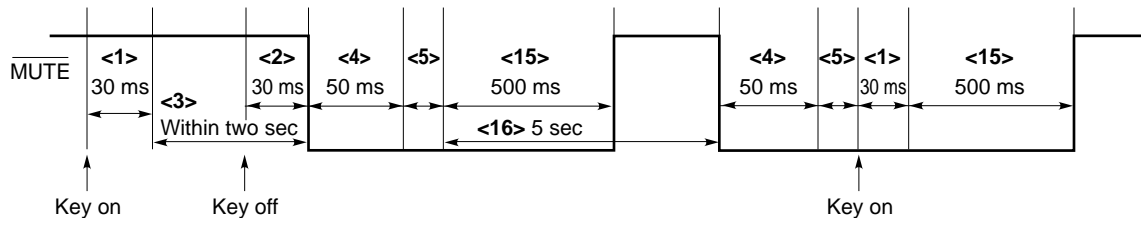

10.5 Auto-Storage

10.5.1 Auto-storage

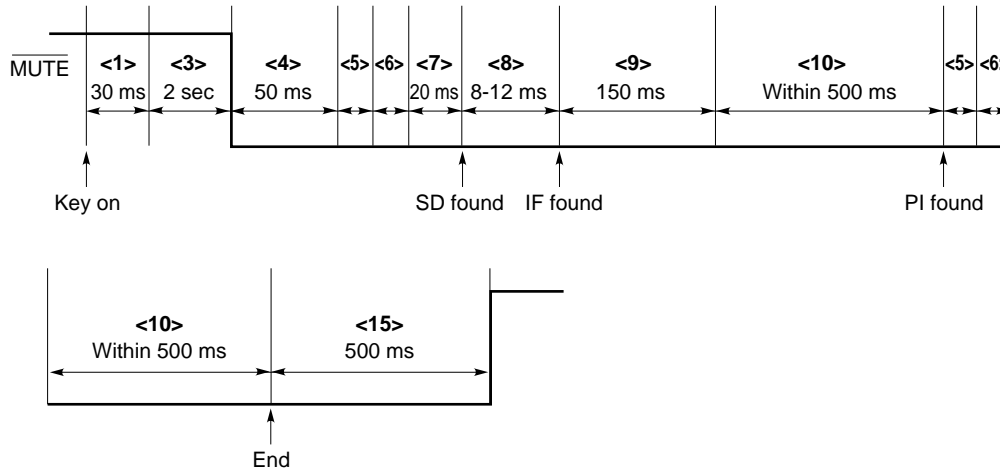

However, time <7> is 600 ms if a band edge is detected in the middle.  
 Time <8> is 16 to 24 ms in the AM band.  
 If an error occurs in <7> or <8>, the next frequency is received (<5>).

10.5.2 TP auto-storage

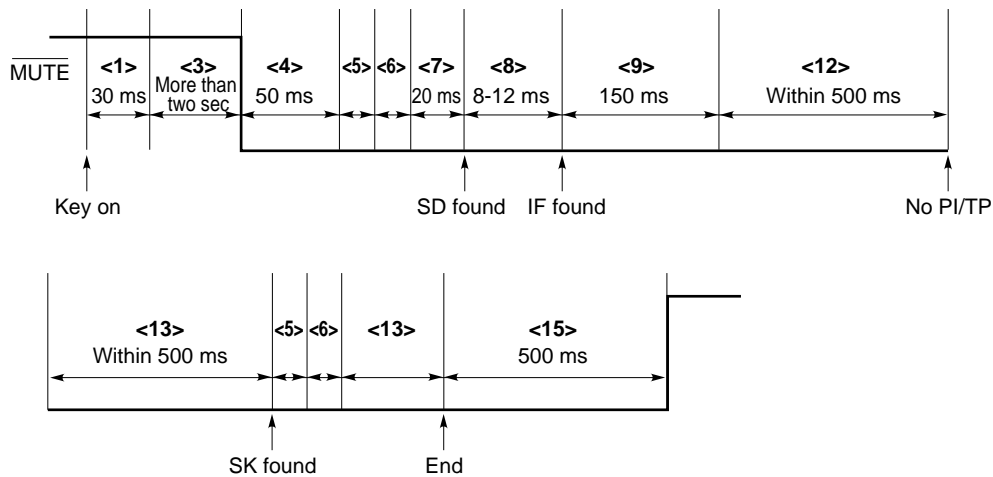

However, time <7> is 600 ms if a band edge is detected in the middle.  
 If an error occurs in <7>, <8>, or <13>, the next frequency is received (<5>).  
 If PI/TP is found in <12>, the next frequency is received (<5>).



10.6 POWER On/Off

10.6.1 Power on

(1) ACC, BATT, and PANEL pins

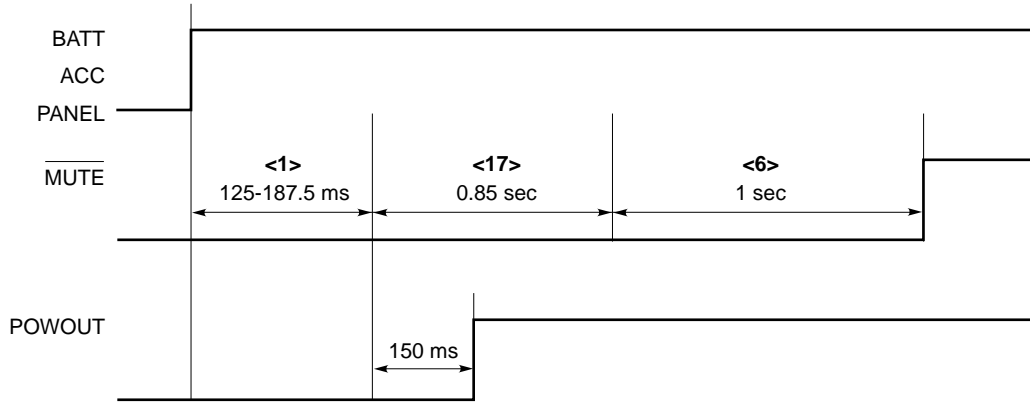

An oscillation stabilization time (31.3 ms) must elapse before <1> in the low current consumption state.

(2) **POWER** key

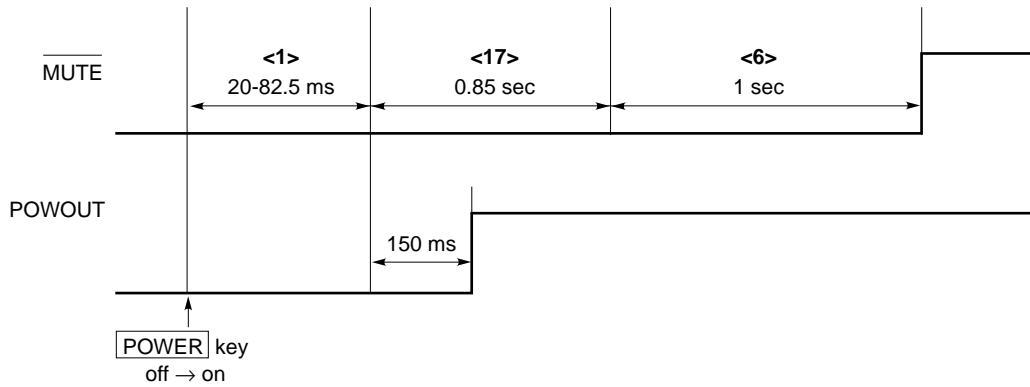

10.6.2 Power off

(1) BATT pin

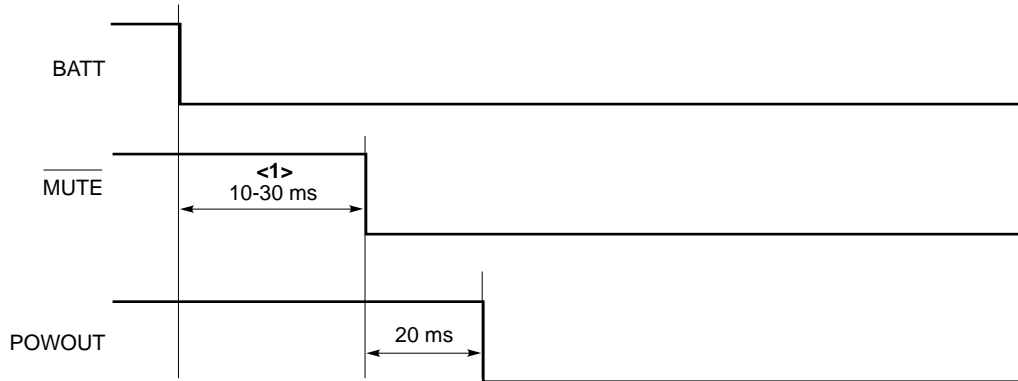

(2) ACC and PANEL pins, and POWER key

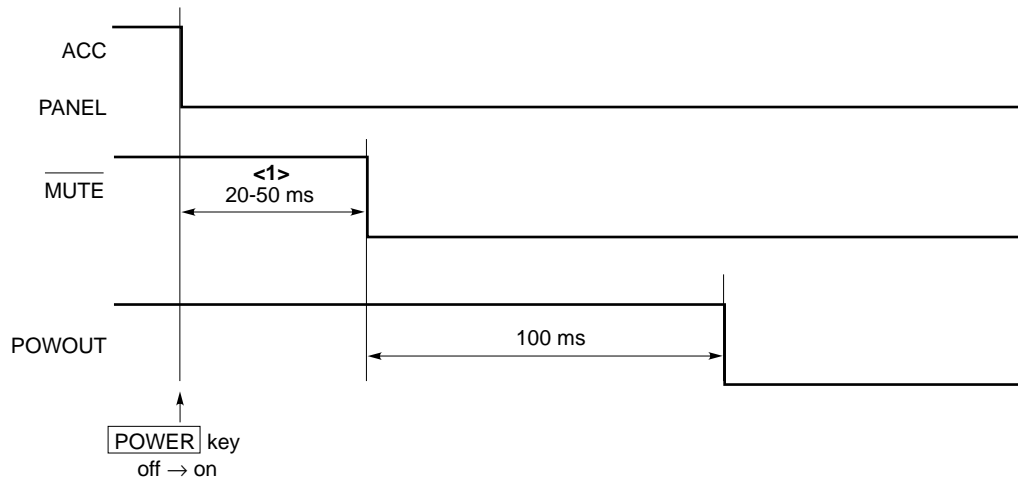

10.7 Mode Switching

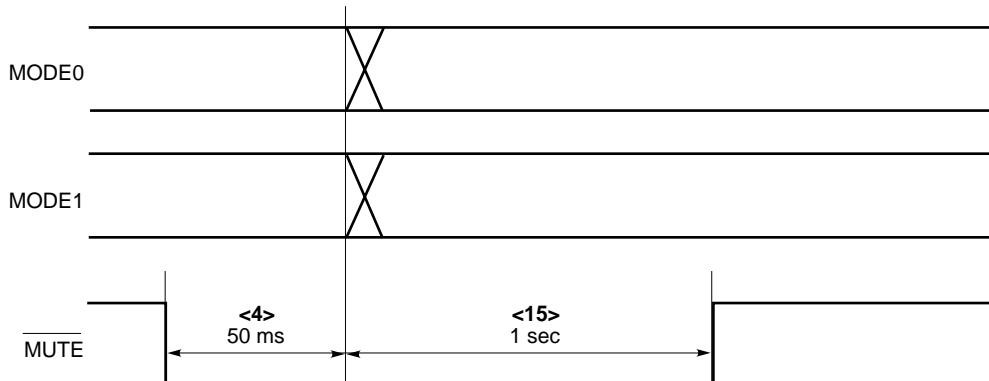

11. SAMPLE APPLICATION CIRCUIT

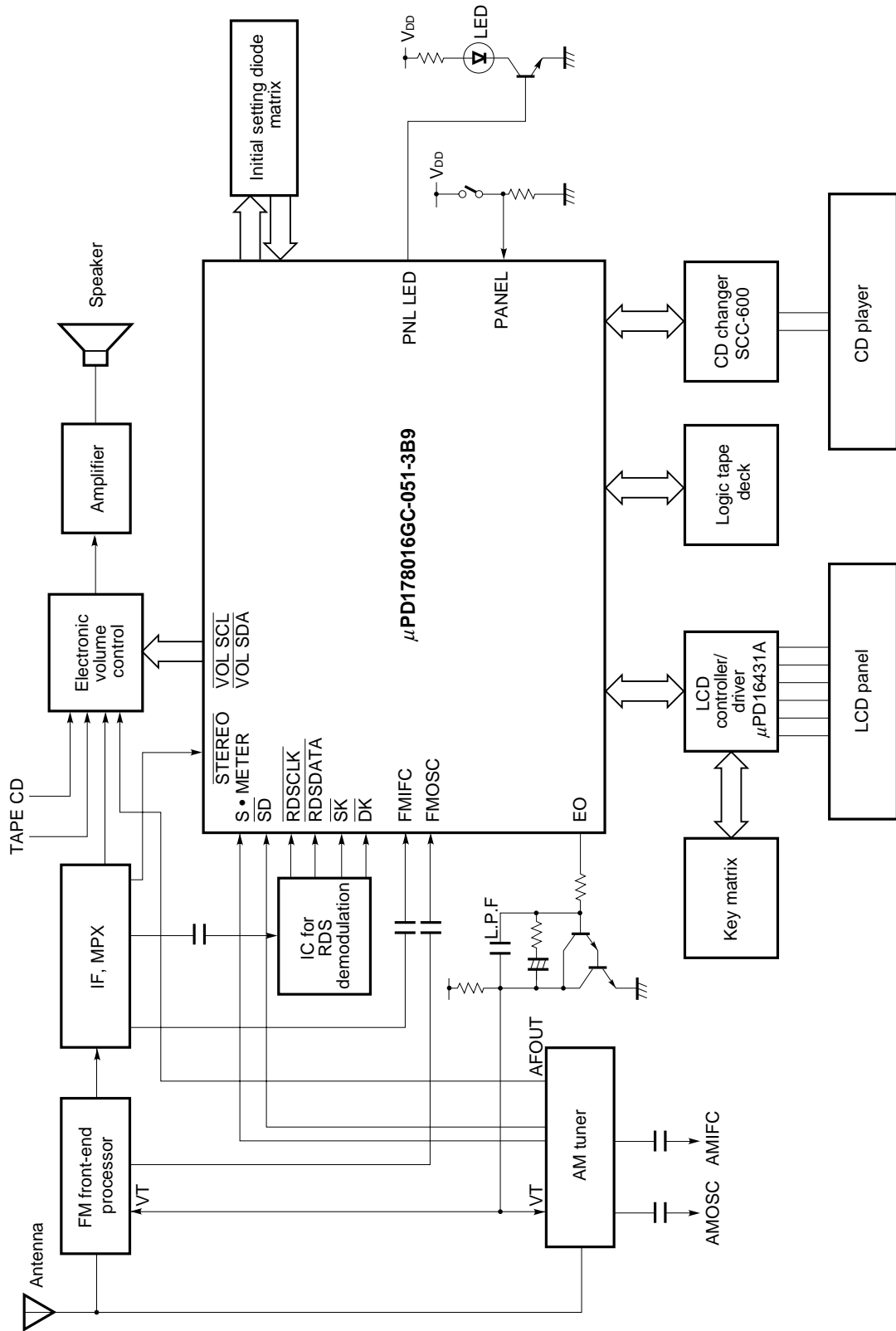

12. ELECTRICAL CHARACTERISTICS (PRELIMINARY)

ABSOLUTE MAXIMUM RATINGS (T<sub>A</sub> = 25 °C)

Parameter	Symbol	Conditions		Rating	Unit
Power supply voltage	V <sub>DD</sub>			-0.3 to +7.0	V
Input voltage	V <sub>I1</sub>	At other than P60-P63		-0.3 to V <sub>DD</sub> + 0.3	V
	V <sub>I2</sub>	P60-P63	N-ch open-drain	-0.3 to +16	V
Output voltage	V <sub>O</sub>			-0.3 to V <sub>DD</sub> + 0.3	V
Output withstand voltage	V <sub>BDS</sub>	P132-P134	N-ch open-drain	16	V
Analog input voltage	V <sub>AN</sub>	P10-P15	Analog input pin	-0.3 to V <sub>DD</sub> + 0.3	V
High-level output current	I <sub>OH</sub>	At one pin		-10	mA
		Total for P01-P06, P30-P37, P56, P57, P60-P67, and P120-P125		-15	mA
		Total for P10-P15, P20-P27, P40-P47, P50-P55, and P132-P134		-5	mA
Low-level output current	I <sub>OL</sub> Note	At one pin	Peak value	15	mA
			rms	7.5	mA
Operating ambient temperature	T <sub>A</sub>			-40 to +85	°C
Storage temperature	T <sub>stg</sub>			-65 to +150	°C

**Note** Calculate a root-mean-square value as follows: [rms value] = [peak value] × √duty cycle.

**Caution** Absolute maximum ratings are rated values beyond which physical damage will be caused to the product; if the rated value of any of the parameters in the above table is exceeded, even momentarily, the quality of the product may deteriorate. Always use the product within its rated values.

RECOMMENDED OPERATING RANGES (T<sub>A</sub> = -40 to +85 °C)

Parameter	Symbol	Conditions	MIN.	TYP.	MAX.	Unit
Power supply voltage	V <sub>DD1</sub>	While the CPU and PLL are operating	4.5		5.5	V
	V <sub>DD2</sub>	While the CPU is operating but the PLL is halted Cycle time: T <sub>CY</sub> ≥ 0.89 μs	3.5		5.5	V
	V <sub>DD3</sub>	While the CPU is operating but the PLL is halted Cycle time: T <sub>CY</sub> = 0.44 μs	4.5		5.5	V

**Remark** T<sub>CY</sub>: Cycle time (minimum instruction execution time)

DC CHARACTERISTICS (T<sub>A</sub> = -40 to +85 °C, V<sub>DD</sub> = 3.5 to 5.5 V)

(1/3)

Parameter	Symbol	Conditions	MIN.	TYP.	MAX.	Unit	
High-level input voltage	V <sub>IH1</sub>	P10-P15, P21, P23, P30-P32, P35-P37, P40-P47, P50-P57, P64-P67, P120-P125	0.7V <sub>DD</sub>		V <sub>DD</sub>	V	
	V <sub>IH2</sub>	P00-P06, P20, P22, P24-P27, P33, P34, RESET	0.85V <sub>DD</sub>		V <sub>DD</sub>	V	
	V <sub>IH3</sub>	P60-P63 (N-ch open-drain)	0.7V <sub>DD</sub>		15	V	
Low-level input voltage	V <sub>IL1</sub>	P10-P15, P21, P23, P30-P32, P35-P37, P40-P47, P50-P57, P64-P67, P120-P125	0		0.3V <sub>DD</sub>	V	
	V <sub>IL2</sub>	P00-P06, P20, P22, P24-P27, P33, P34, RESET	0		0.15V <sub>DD</sub>	V	
	V <sub>IL3</sub>	P60-P63 (N-ch open-drain)	4.5 V ≤ V <sub>DD</sub> ≤ 5.5 V	0		0.3V <sub>DD</sub>	V
3.5 V ≤ V <sub>DD</sub> < 4.5 V			0		0.2V <sub>DD</sub>	V	
High-level output voltage	V <sub>OH1</sub>	4.5 V ≤ V <sub>DD</sub> ≤ 5.5 V, I <sub>OH</sub> = -1 mA	V <sub>DD</sub> - 1.0			V	
		3.5 V ≤ V <sub>DD</sub> < 4.5 V, I <sub>OH</sub> = -100 μA	V <sub>DD</sub> - 0.5			V	
Low-level output voltage	V <sub>OL1</sub>	P50-P57, P60-P63	V <sub>DD</sub> = 4.5 to 5.5 V, I <sub>OL</sub> = 15 mA		0.4	2.0	V
		P01-P06, P10-P15, P20-P27, P30-P37, P40-P47, P64-P67, P120-P125, P132-P134	V <sub>DD</sub> = 4.5 to 5.5 V, I <sub>OL</sub> = 1.6 mA			0.4	V
	V <sub>OL2</sub>	SB0, SB1, SCK0	V <sub>DD</sub> = 4.5 to 5.5 V, When N-ch open-drain is pulled up (R = 1 kΩ)			0.2V <sub>DD</sub>	V

**Remark** Unless otherwise specified, the characteristics of dual-function pins are as same as those of port pins.

DC CHARACTERISTICS (T<sub>A</sub> = -40 to +85 °C, V<sub>DD</sub> = 3.5 to 5.5 V)

(2/3)

Parameter	Symbol	Conditions	MIN.	TYP.	MAX.	Unit
High-level input leakage current	I <sub>LH1</sub>	P00-P06, P10-P15, P20-P27, P30-P37, P40-P47, P50-P57, P64-P67, P120-P125, RESET	V <sub>IN</sub> = V <sub>DD</sub>		3	μA
	I <sub>LH2</sub>	P60-P63	V <sub>IN</sub> = 15 V		80	μA
Low-level input leakage current	I <sub>LIL1</sub>	P00-P06, P10-P15, P20-P27, P30-P37, P40-P47, P50-P57, P64-P67, P120-P125, RESET	V <sub>IN</sub> = 0 V		-3	μA
	I <sub>LIL2</sub>	P60-P63			-3Note	μA
High-level output leakage current	I <sub>LOH</sub>	P132-P134	V <sub>OUT</sub> = 15 V		3	μA
Low-level output leakage current	I <sub>LOL</sub>	P132-P134	V <sub>OUT</sub> = 0 V		-3	μA
Output-off leakage current	I <sub>LOF</sub>	EO0, EO1	V <sub>OUT</sub> = V <sub>DD</sub> , V <sub>OUT</sub> = 0 V		±1	μA

**Note** A low-level input leakage current of -200 μA (MAX.) flows between P60 and P63 only for one clock when an input instruction is executed. During the period other than the one clock, a low-level input leakage current of -3 μA (MAX.) flows.

**Remark** Unless otherwise specified, the characteristic of dual-function pins are as same as those of port pins.

REFERENCE CHARACTERISTICS (T<sub>A</sub> = 25 °C, V<sub>DD</sub> = 5 V)

(1/2)

Parameter	Symbol	Conditions	MIN.	TYP.	MAX.	Unit
High-level output current	I <sub>OH1</sub>	EO0	V <sub>OUT</sub> = V <sub>DD</sub> - 1 V		-4	mA
		EO1 (EOCON0 = 1)			-6	mA
		EO1 (EOCON0 = 0)			-2	mA
Low-level output current	I <sub>OL1</sub>	EO0	V <sub>OUT</sub> = 1 V		6	mA
		EO1 (EOCON0 = 1)			8	mA
		EO1 (EOCON0 = 0)			3	mA

DC CHARACTERISTICS (T<sub>A</sub> = -40 to +85 °C, V<sub>DD</sub> = 3.5 to 5.5 V)

(3/3)

Parameter	Symbol	Conditions	MIN.	TYP.	MAX.	Unit
Supply current <sup>Note 1</sup>	I <sub>DD1</sub>	While the CPU is operating but the PLL is halted At f <sub>X</sub> = 4.5 MHz	T <sub>CY</sub> = 0.89 μs <sup>Note 2</sup>	2.5	15	mA
	I <sub>DD2</sub>		T <sub>CY</sub> = 0.44 μs <sup>Note 3</sup> V <sub>DD</sub> = 4.5 to 5.5 V	4.0	27	mA
	I <sub>DD3</sub>	While the CPU is operating but the PLL is halted HALT mode A sinusoidal wave is applied to the X1 pin (V <sub>IN</sub> = V <sub>DD</sub> ). At f <sub>X</sub> = 4.5 MHz	T <sub>CY</sub> = 0.89 μs <sup>Note 2</sup>	0.7	1.5	mA
	I <sub>DD4</sub>		T <sub>CY</sub> = 0.44 μs <sup>Note 3</sup> V <sub>DD</sub> = 4.5 to 5.5 V	1.0	2.0	mA
Data hold supply voltage	V <sub>DDR1</sub>	While the crystal oscillator is operating	T <sub>CY</sub> = 0.44 μs	4.5	5.5	V
	V <sub>DDR2</sub>		T <sub>CY</sub> = 0.89 μs	3.5	5.5	V
	V <sub>DDR3</sub>	While the crystal oscillator is halted When the power failure is detected by power-on clear		2.6	5.5	V
Data hold supply current	I <sub>DDR1</sub>	While the crystal oscillator is halted	T <sub>A</sub> = 25 °C V <sub>DD</sub> = 5 V	2	4	μA
	I <sub>DDR2</sub>			2	30	μA

**Notes** 1. The port current is not included.

- 2. When both the processor clock control register (PCC) and the oscillation mode selection register (OSMS) are set to 00H
- 3. When the PCC is set to 00H, and the OSMS is set to 01H

**Remarks** 1. T<sub>CY</sub>: Cycle time (minimum instruction execution time)

2. f<sub>X</sub>: System clock oscillator frequency

REFERENCE CHARACTERISTICS (T<sub>A</sub> = 25 °C, V<sub>DD</sub> = 5 V)

(2/2)

Parameter	Symbol	Conditions	MIN.	TYP.	MAX.	Unit
Supply current	I <sub>DD5</sub>	While the CPU and PLL are operating A sinusoidal wave is applied to the VCOH pin. f <sub>IN</sub> = 130 MHz, V <sub>IN</sub> = 0.15 V <sub>P-P</sub>		7		mA

**Note** When the processor clock control register (PCC) is set to 00H and the oscillation mode selection register (OSMS) is set to 01H

**Remark** T<sub>CY</sub>: Cycle time (minimum instruction execution time)

AC CHARACTERISTICS

Basic Operations (T<sub>A</sub> = -40 to +85 °C, V<sub>DD</sub> = 3.5 to 5.5 V)

Parameter	Symbol	Conditions	MIN.	TYP.	MAX.	Unit	
Cycle time (minimum instruction execution time)	T <sub>CY</sub>	At f <sub>XX</sub> = f <sub>X</sub> /2 <sup>Note 1</sup> and f <sub>X</sub> = 4.5 MHz	0.89		14.22	μs	
		At f <sub>XX</sub> = f <sub>X</sub> <sup>Note 2</sup> and f <sub>X</sub> = 4.5 MHz	4.5 V ≤ V <sub>DD</sub> ≤ 5.5 V	0.44		7.11	μs
			3.5 V ≤ V <sub>DD</sub> < 4.5 V	0.89		7.11	μs
RESET low-level width	t <sub>RSL</sub>		10			μs	

- Notes**
1. When the oscillation mode selection register (OSMS) is set to 00H
  2. When the OSMS is set to 01H

- Remarks**
1. f<sub>XX</sub>: System clock frequency (f<sub>X</sub> or f<sub>X</sub>/2)
  2. f<sub>X</sub>: System clock oscillator frequency



**A/D CONVERTER CHARACTERISTICS (T<sub>A</sub> = -40 to +85 °C, V<sub>DD</sub> = 4.5 to 5.5 V)**

Parameter	Symbol	Conditions	MIN.	TYP.	MAX.	Unit
Resolution			8	8	8	bit
Total error in conversion					±3.0	LSB
Conversion time	t <sub>CONV</sub>		22.2		44.4	μs
Sampling time	t <sub>SAMP</sub>		15/f <sub>XX</sub>			μs
Analog input voltage	V <sub>IAN</sub>		0		V <sub>DD</sub>	V

- Remarks 1.** f<sub>XX</sub>: System clock frequency (f<sub>X</sub>/2)  
**2.** f<sub>X</sub>: System clock oscillator frequency

**PLL CHARACTERISTICS (T<sub>A</sub> = -40 to +85 °C, V<sub>DD</sub> = 4.5 to 5.5 V)**

Parameter	Symbol	Conditions	MIN.	TYP.	MAX.	Unit
Operating frequency	f <sub>IN1</sub>	VCOL pin in MF mode, with a sinusoidal wave applied to the V <sub>IN</sub> pin = 0.1 V <sub>P-P</sub>	0.5		3	MHz
	f <sub>IN2</sub>	VCOL pin in HF mode, with a sinusoidal wave applied to the V <sub>IN</sub> pin = 0.2 V <sub>P-P</sub>	9		55	MHz
	f <sub>IN3</sub>	VCOH pin in VMF mode, with a sinusoidal wave applied to the V <sub>IN</sub> pin = 0.15 V <sub>P-P</sub>	60		160	MHz

**IFC CHARACTERISTICS (T<sub>A</sub> = -40 to +85 °C, V<sub>DD</sub> = 4.5 to 5.5 V)**

Parameter	Symbol	Conditions	MIN.	TYP.	MAX.	Unit
Operating frequency	f <sub>IN4</sub>	AMIFC pin in AMIF count mode, with a sinusoidal wave applied to the V <sub>IN</sub> pin = 0.1 V <sub>P-P</sub> <b>Note</b>	0.4		0.5	MHz
	f <sub>IN5</sub>	FMIFC pin in FMIF count mode, with a sinusoidal wave applied to the V <sub>IN</sub> pin = 0.1 V <sub>P-P</sub> <b>Note</b>	10		11	MHz
	f <sub>IN6</sub>	FMIFC pin in AMIF count mode, with a sinusoidal wave applied to the V <sub>IN</sub> pin = 0.1 V <sub>P-P</sub> <b>Note</b>	0.4		0.5	MHz

**Note** The condition of sinusoidal wave input V<sub>IN</sub> = 0.1 V<sub>P-P</sub> is the rated value when the μPD178016GC-051 alone is operating. Where influence of noise must be taken into consideration, operation under input amplitude condition of V<sub>IN</sub> = 0.15 V<sub>P-P</sub> is recommended.

13. PACKAGE DRAWING

80 PIN PLASTIC QFP (14×14)

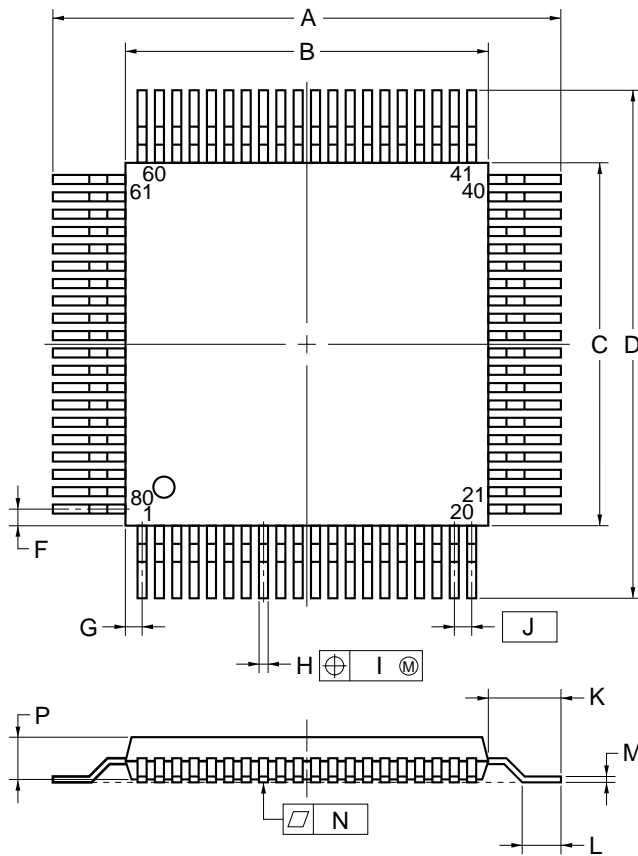

detail of lead end

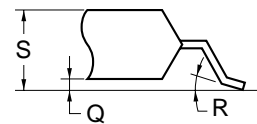

NOTE

Each lead centerline is located within 0.13 mm (0.005 inch) of its true position (T.P.) at maximum material condition.

ITEM	MILLIMETERS	INCHES
A	17.2±0.4	0.677±0.016
B	14.0±0.2	0.551 <sup>+0.009</sup> <sub>-0.008</sub>
C	14.0±0.2	0.551 <sup>+0.009</sup> <sub>-0.008</sub>
D	17.2±0.4	0.677±0.016
F	0.825	0.032
G	0.825	0.032
H	0.30±0.10	0.012 <sup>+0.004</sup> <sub>-0.005</sub>
I	0.13	0.005
J	0.65 (T.P.)	0.026 (T.P.)
K	1.6±0.2	0.063±0.008
L	0.8±0.2	0.031 <sup>+0.009</sup> <sub>-0.008</sub>
M	0.15 <sup>+0.10</sup> <sub>-0.05</sub>	0.006 <sup>+0.004</sup> <sub>-0.003</sub>
N	0.10	0.004
P	2.7	0.106
Q	0.1±0.1	0.004±0.004
R	5°±5°	5°±5°
S	3.0 MAX.	0.119 MAX.

S80GC-65-3B9-4

**14. RECOMMENDED SOLDERING CONDITIONS**

The conditions listed below shall be met when soldering the μPD178016GC-051.

For details of the recommended soldering conditions, refer to our document **SMD Surface Mount Technology Manual (C10535E)**.

Please consult with our sales offices in case any other soldering process is used, or in case soldering is done under different conditions.

**Table 14-1. Soldering Conditions for Surface-Mount Devices**

**μPD178016GC-051-3B9: 80-pin plastic QFP (14 × 14 mm, 0.65-mm pitch)**

Soldering process	Soldering conditions	Symbol
Infrared ray reflow	Peak package's surface temperature: 235 °C Reflow time: 30 seconds or less (at 210 °C or more) Maximum allowable number of reflow processes: 3	IR35-00-3
VPS	Peak package's surface temperature: 215 °C Reflow time: 40 seconds or less (at 200 °C or more) Maximum allowable number of reflow processes: 3	VP15-00-3
Wave soldering	Solder temperature: 260 °C or less Flow time: 10 seconds or less Number of flow processes: 1 Preheating temperature: 120 °C max. (measured on the package surface)	WS60-00-1
Partial heating method	Terminal temperature: 300 °C or less Heat time: 3 seconds or less (for one side of a device)	—

**Caution** Do not apply more than a single process at once, except for “Partial heating method.”

## NOTES FOR CMOS DEVICES

### ① PRECAUTION AGAINST ESD FOR SEMICONDUCTORS

**Note:** Strong electric field, when exposed to a MOS device, can cause destruction of the gate oxide and ultimately degrade the device operation. Steps must be taken to stop generation of static electricity as much as possible, and quickly dissipate it once, when it has occurred. Environmental control must be adequate. When it is dry, humidifier should be used. It is recommended to avoid using insulators that easily build static electricity. Semiconductor devices must be stored and transported in an anti-static container, static shielding bag or conductive material. All test and measurement tools including work bench and floor should be grounded. The operator should be grounded using wrist strap. Semiconductor devices must not be touched with bare hands. Similar precautions need to be taken for PW boards with semiconductor devices on it.

### ② HANDLING OF UNUSED INPUT PINS FOR CMOS

**Note:** No connection for CMOS device inputs can be cause of malfunction. If no connection is provided to the input pins, it is possible that an internal input level may be generated due to noise, etc., hence causing malfunction. CMOS device behave differently than Bipolar or NMOS devices. Input levels of CMOS devices must be fixed high or low by using a pull-up or pull-down circuitry. Each unused pin should be connected to  $V_{DD}$  or GND with a resistor, if it is considered to have a possibility of being an output pin. All handling related to the unused pins must be judged device by device and related specifications governing the devices.

### ③ STATUS BEFORE INITIALIZATION OF MOS DEVICES

**Note:** Power-on does not necessarily define initial status of MOS device. Production process of MOS does not define the initial operation status of the device. Immediately after the power source is turned ON, the devices with reset function have not yet been initialized. Hence, power-on does not guarantee out-pin levels, I/O settings or contents of registers. Device is not initialized until the reset signal is received. Reset operation must be executed immediately after power-on for devices having reset function.

[MEMO]

**Caution** This product contains an I<sup>2</sup>C bus interface circuit.  
When using the I<sup>2</sup>C bus interface, notify its use to NEC when ordering custom code. NEC can guarantee the following only when the customer informs NEC of the use of the interface:  
Purchase of NEC I<sup>2</sup>C components conveys a license under the Philips I<sup>2</sup>C Patent Rights to use these components in an I<sup>2</sup>C system, provided that the system conforms to the I<sup>2</sup>C Standard Specification as defined by Philips.

## Regional Information

Some information contained in this document may vary from country to country. Before using any NEC product in your application, please contact the NEC office in your country to obtain a list of authorized representatives and distributors. They will verify:

- Device availability
- Ordering information
- Product release schedule
- Availability of related technical literature
- Development environment specifications (for example, specifications for third-party tools and components, host computers, power plugs, AC supply voltages, and so forth)
- Network requirements

In addition, trademarks, registered trademarks, export restrictions, and other legal issues may also vary from country to country.

### **NEC Electronics Inc. (U.S.)**

Santa Clara, California  
Tel: 800-366-9782  
Fax: 800-729-9288

### **NEC Electronics (Germany) GmbH**

Duesseldorf, Germany  
Tel: 0211-65 03 02  
Fax: 0211-65 03 490

### **NEC Electronics (UK) Ltd.**

Milton Keynes, UK  
Tel: 01908-691-133  
Fax: 01908-670-290

### **NEC Electronics Italiana s.r.l.**

Milano, Italy  
Tel: 02-66 75 41  
Fax: 02-66 75 42 99

### **NEC Electronics (Germany) GmbH**

Benelux Office  
Eindhoven, The Netherlands  
Tel: 040-2445845  
Fax: 040-2444580

### **NEC Electronics (France) S.A.**

Velizy-Villacoublay, France  
Tel: 01-30-67 58 00  
Fax: 01-30-67 58 99

### **NEC Electronics (France) S.A.**

Spain Office  
Madrid, Spain  
Tel: 01-504-2787  
Fax: 01-504-2860

### **NEC Electronics (Germany) GmbH**

Scandinavia Office  
Taeby, Sweden  
Tel: 08-63 80 820  
Fax: 08-63 80 388

### **NEC Electronics Hong Kong Ltd.**

Hong Kong  
Tel: 2886-9318  
Fax: 2886-9022/9044

### **NEC Electronics Hong Kong Ltd.**

Seoul Branch  
Seoul, Korea  
Tel: 02-528-0303  
Fax: 02-528-4411

### **NEC Electronics Singapore Pte. Ltd.**

United Square, Singapore 1130  
Tel: 253-8311  
Fax: 250-3583

### **NEC Electronics Taiwan Ltd.**

Taipei, Taiwan  
Tel: 02-719-2377  
Fax: 02-719-5951

### **NEC do Brasil S.A.**

Sao Paulo-SP, Brasil  
Tel: 011-889-1680  
Fax: 011-889-1689

[MEMO]

The application circuits and their parameters are for reference only and are not intended for use in actual design-ins.

No part of this document may be copied or reproduced in any form or by any means without the prior written consent of NEC Corporation. NEC Corporation assumes no responsibility for any errors which may appear in this document.

NEC Corporation does not assume any liability for infringement of patents, copyrights or other intellectual property rights of third parties by or arising from use of a device described herein or any other liability arising from use of such device. No license, either express, implied or otherwise, is granted under any patents, copyrights or other intellectual property rights of NEC Corporation or others.

While NEC Corporation has been making continuous effort to enhance the reliability of its semiconductor devices, the possibility of defects cannot be eliminated entirely. To minimize risks of damage or injury to persons or property arising from a defect in an NEC semiconductor device, customers must incorporate sufficient safety measures in its design, such as redundancy, fire-containment, and anti-failure features.

NEC devices are classified into the following three quality grades:

"Standard", "Special", and "Specific". The Specific quality grade applies only to devices developed based on a customer designated "quality assurance program" for a specific application. The recommended applications of a device depend on its quality grade, as indicated below. Customers must check the quality grade of each device before using it in a particular application.

**Standard:** Computers, office equipment, communications equipment, test and measurement equipment, audio and visual equipment, home electronic appliances, machine tools, personal electronic equipment and industrial robots

**Special:** Transportation equipment (automobiles, trains, ships, etc.), traffic control systems, anti-disaster systems, anti-crime systems, safety equipment and medical equipment (not specifically designed for life support)

**Specific:** Aircrafts, aerospace equipment, submersible repeaters, nuclear reactor control systems, life support systems or medical equipment for life support, etc.

The quality grade of NEC devices is "Standard" unless otherwise specified in NEC's Data Sheets or Data Books. If customers intend to use NEC devices for applications other than those specified for Standard quality grade, they should contact an NEC sales representative in advance.

Anti-radioactive design is not implemented in this product.