

2.5V Drive Nch MOS FET

2SK3541

●Structure

Silicon N-channel
MOSFET

●Applications

Interfacing, switching (30V, 100mA)

●Features

- 1) Low on-resistance.
- 2) Fast switching speed.
- 3) Low voltage drive (2.5V) makes this device ideal for portable equipment.
- 4) Drive circuits can be simple.
- 5) Parallel use is easy.

●Packaging specifications

Type	Package	Taping
	Code	T2L
	Basic ordering unit (pieces)	8000
2SK3541		○

●Absolute maximum ratings (Ta=25°C)

Parameter	Symbol	Limits	Unit	
Drain-source voltage	V_{DS}	30	V	
Gate-source voltage	V_{GS}	± 20	V	
Drain current	Continuous	I_D	± 100	mA
	Pulsed	I_{DP}^{*1}	± 400	mA
Total power dissipation	P_D^{*2}	150	mW	
Channel temperature	T_{ch}	150	°C	
Storage temperature	T_{stg}	-55 to +150	°C	

*1 $P_w \leq 10\mu s$, Duty cycle $\leq 1\%$

*2 With each pin mounted on the recommended lands.

●External dimensions (Unit : mm)

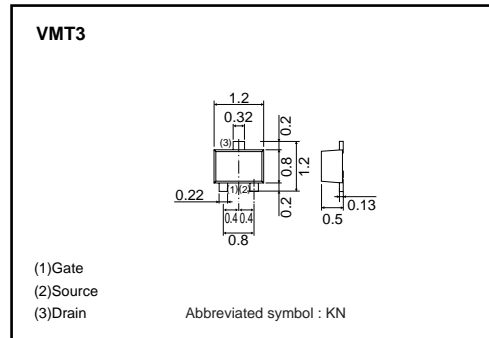

●Equivalent circuit

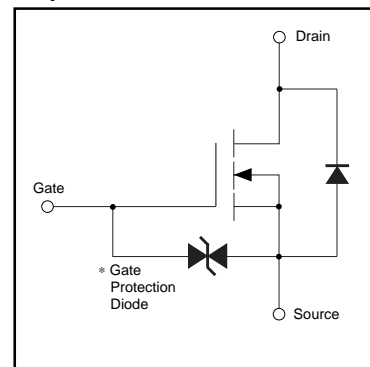

*A protection diode is included between the gate and the source terminals to protect the diode against static electricity when the product is in use. Use a protection circuit when the fixed voltages are exceeded.

Transistor

●Electrical characteristics (Ta=25°C)

Parameter	Symbol	Min.	Typ.	Max.	Unit	Conditions
Gate-source leakage	I _{GSS}	-	-	±1	μA	V _{GS} =±20V, V _{DS} =0V
Drain-source breakdown voltage	V _{(BR)DSS}	30	-	-	V	I _D =10μA, V _{GS} =0V
Zero gate voltage drain current	I _{DSS}	-	-	1.0	μA	V _{DS} =30V, V _{GS} =0V
Gate threshold voltage	V _{GS(th)}	0.8	-	1.5	V	V _{DS} =3V, I _D =100μA
Static drain-source on-state resistance	R _{DS(on)}	-	5	8	Ω	I _D =10mA, V _{GS} =4V
	R _{DS(on)}	-	7	13	Ω	I _D =1mA, V _{GS} =2.5V
Forward transfer admittance	Y _{fs}	20	-	-	mS	I _D =10mA, V _{DS} =3V
Input capacitance	C _{iss}	-	13	-	pF	V _{DS} =5V
Output capacitance	C _{oss}	-	9	-	pF	V _{GS} =0V
Reverse transfer capacitance	C _{rss}	-	4	-	pF	f=1MHz
Turn-on delay time	t _{d(on)}	-	15	-	ns	I _D =10mA, V _{DD} ≐ 5V
Rise time	t _r	-	35	-	ns	V _{GS} =5V
Turn-off delay time	t _{d(off)}	-	80	-	ns	R _L =500Ω
Fall time	t _f	-	80	-	ns	R _G =10Ω

●Electrical characteristic curves

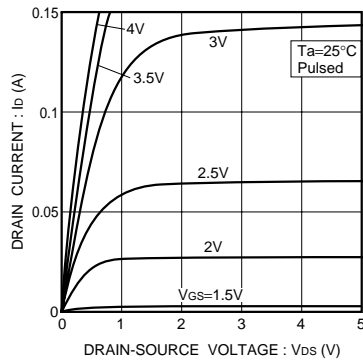

Fig.1 Typical output characteristics

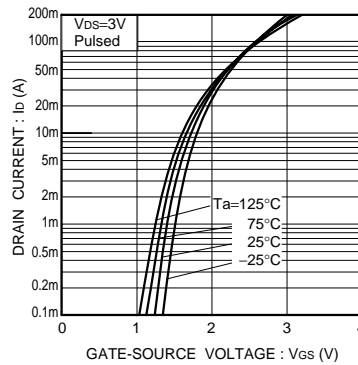

Fig.2 Typical transfer characteristics

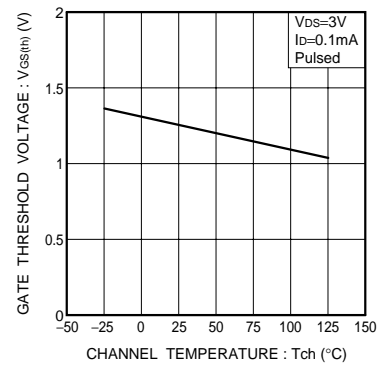

Fig.3 Gate threshold voltage vs. channel temperature

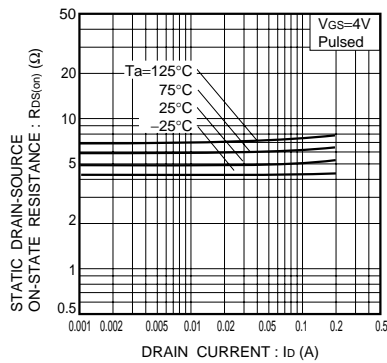

Fig.4 Static drain-source on-state resistance vs. drain current (I)

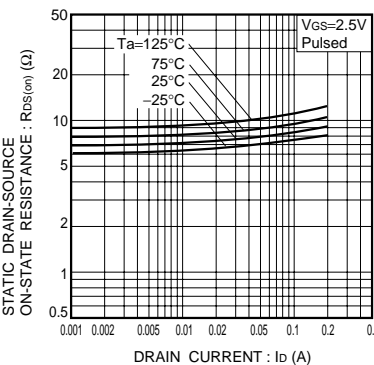

Fig.5 Static drain-source on-state resistance vs. drain current (II)

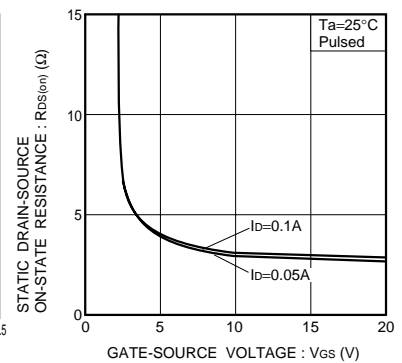

Fig.6 Static drain-source on-state resistance vs. gate-source voltage

Transistor

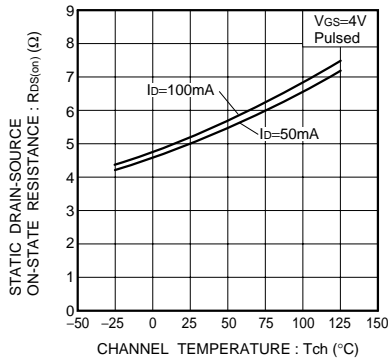

Fig.7 Static drain-source on-state resistance vs. channel temperature

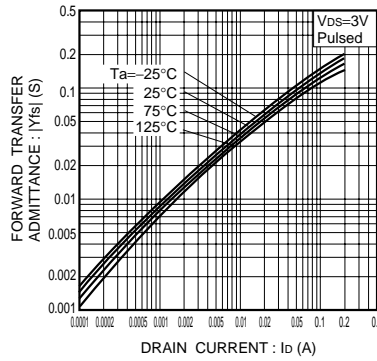

Fig.8 Forward transfer admittance vs. drain current

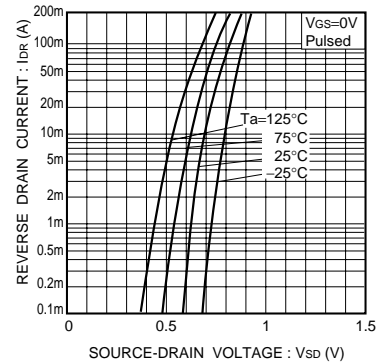

Fig.9 Reverse drain current vs. source-drain voltage (I)

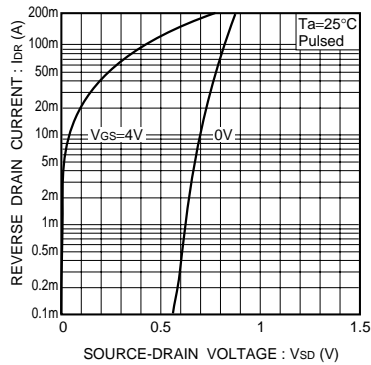

Fig.10 Reverse drain current vs. source-drain voltage (II)

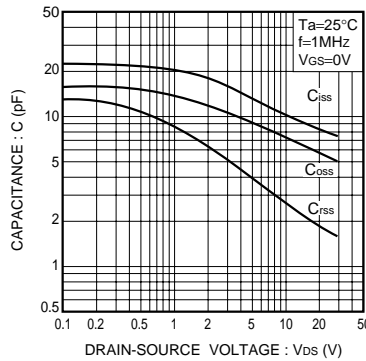

Fig.11 Typical capacitance vs. drain-source voltage

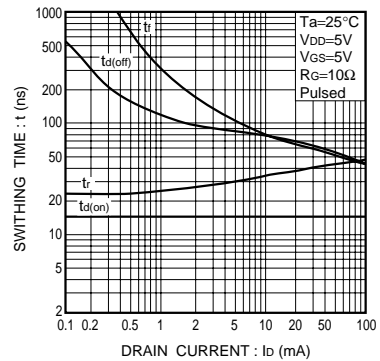

Fig.12 Switching characteristics (See Figures 13 and 14 for the measurement circuit and resultant waveforms)

●Switching characteristics measurement circuit

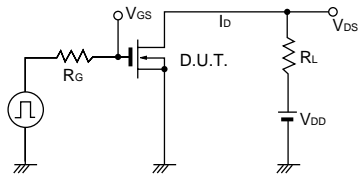

Fig.13 Switching time measurement circuit

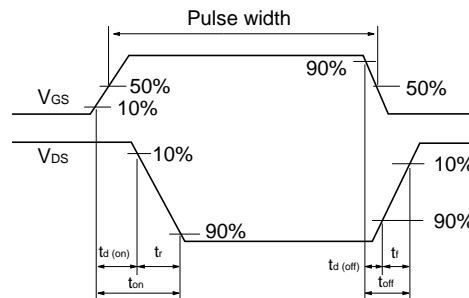

Fig.14 Switching time waveforms

Notes

- 1) The information contained herein is subject to change without notice.
- 2) Before you use our Products, please contact our sales representative and verify the latest specifications :
- 3) Although ROHM is continuously working to improve product reliability and quality, semiconductors can break down and malfunction due to various factors.
Therefore, in order to prevent personal injury or fire arising from failure, please take safety measures such as complying with the derating characteristics, implementing redundant and fire prevention designs, and utilizing backups and fail-safe procedures. ROHM shall have no responsibility for any damages arising out of the use of our Products beyond the rating specified by ROHM.
- 4) Examples of application circuits, circuit constants and any other information contained herein are provided only to illustrate the standard usage and operations of the Products. The peripheral conditions must be taken into account when designing circuits for mass production.
- 5) The technical information specified herein is intended only to show the typical functions of and examples of application circuits for the Products. ROHM does not grant you, explicitly or implicitly, any license to use or exercise intellectual property or other rights held by ROHM or any other parties. ROHM shall have no responsibility whatsoever for any dispute arising out of the use of such technical information.
- 6) The Products are intended for use in general electronic equipment (i.e. AV/OA devices, communication, consumer systems, gaming/entertainment sets) as well as the applications indicated in this document.
- 7) The Products specified in this document are not designed to be radiation tolerant.
- 8) For use of our Products in applications requiring a high degree of reliability (as exemplified below), please contact and consult with a ROHM representative : transportation equipment (i.e. cars, ships, trains), primary communication equipment, traffic lights, fire/crime prevention, safety equipment, medical systems, servers, solar cells, and power transmission systems.
- 9) Do not use our Products in applications requiring extremely high reliability, such as aerospace equipment, nuclear power control systems, and submarine repeaters.
- 10) ROHM shall have no responsibility for any damages or injury arising from non-compliance with the recommended usage conditions and specifications contained herein.
- 11) ROHM has used reasonable care to ensure the accuracy of the information contained in this document. However, ROHM does not warrant that such information is error-free, and ROHM shall have no responsibility for any damages arising from any inaccuracy or misprint of such information.
- 12) Please use the Products in accordance with any applicable environmental laws and regulations, such as the RoHS Directive. For more details, including RoHS compatibility, please contact a ROHM sales office. ROHM shall have no responsibility for any damages or losses resulting from non-compliance with any applicable laws or regulations.
- 13) When providing our Products and technologies contained in this document to other countries, you must abide by the procedures and provisions stipulated in all applicable export laws and regulations, including without limitation the US Export Administration Regulations and the Foreign Exchange and Foreign Trade Act.
- 14) This document, in part or in whole, may not be reprinted or reproduced without prior consent of ROHM.



Thank you for your accessing to ROHM product informations.
More detail product informations and catalogs are available, please contact us.

ROHM Customer Support System

<http://www.rohm.com/contact/>