



N-Channel Enhancement Mode Power MOSFET

MTE55N10FP

BV_{DSS}	100V
I_D	18A
R_{DS(ON)}@ V_{GS}=10V, I_D=18A	55.4 mΩ (typ)
R_{DS(ON)}@ V_{GS}=7V, I_D=12A	56.1 mΩ (typ)

Description

The MTE55N10FP is a N-channel enhancement-mode MOSFET, providing the designer with the best combination of fast switching, ruggedized device design, low on-resistance and cost effectiveness. The TO-220FP package is universally preferred for all commercial-industrial applications

Features

- Low On Resistance
- Simple Drive Requirement
- Low Gate Charge
- Fast Switching Characteristic
- Insulating package, front/back side insulating voltage=2500V(AC)
- RoHS compliant package

Ordering Information

Device	Package	Shipping
MTE55N10FP-0-UB-S	TO-220FP (RoHS compliant package)	50 pcs/tube, 20 tubes/box, 4 boxes / carton

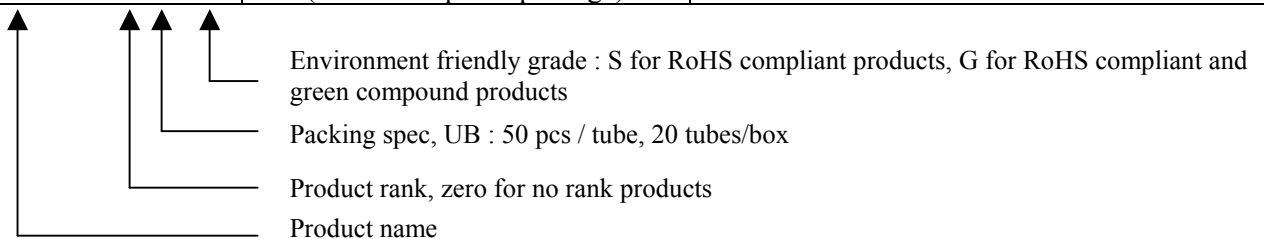

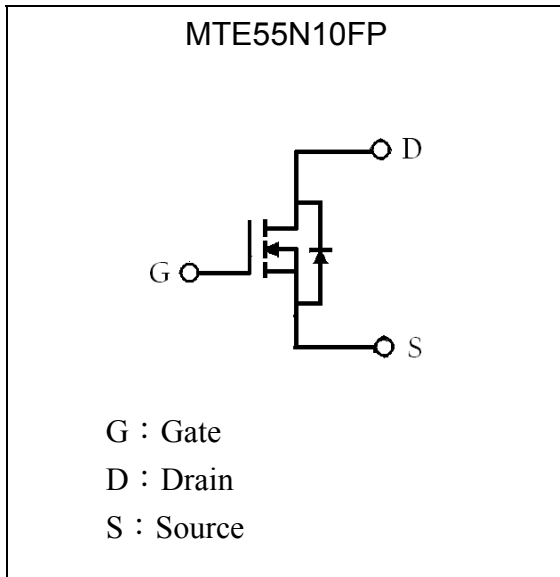
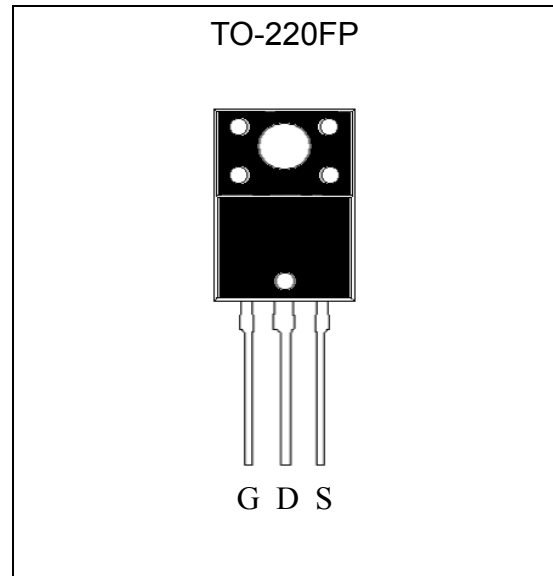
Symbol

Outline

Absolute Maximum Ratings (T_C=25°C)

Parameter		Symbol	Limits	Unit
Drain-Source Voltage (Note 1)		V _{DS}	100	V
Gate-Source Voltage		V _{GS}	±30	
Continuous Drain Current @T _C =25°C, V _{GS} =10V (Note 1)		I _D	18*	A
Continuous Drain Current @T _C =100°C, V _{GS} =10V (Note 1)			13*	
Continuous Drain Current @T _A =25°C, V _{GS} =10V (Note 2)		I _{DSM}	4.2	
Continuous Drain Current @T _A =70°C, V _{GS} =10V (Note 2)			3.4	
Pulsed Drain Current @ V _{GS} =10V (Note 3)		I _{DM}	72*	
Avalanche Current (Note 3)		I _{AR}	20	
Single Pulse Avalanche Energy @ L=0.1mH, I _D =20 Amps, V _{DD} =50V (Note 2)		E _{AS}	20	mJ
Repetitive Avalanche Energy (Note 3)		E _{AR}	4.2	W
Power Dissipation	T _C =25°C (Note 1)	P _D	42	
	T _C =100°C (Note 1)		21	
	T _A =25°C (Note 2)	P _D _{SM}	2.1	
	T _A =70°C (Note 2)		1.4	
Maximum Temperature for Soldering @ Lead at 0.063 in(1.6mm) from case for 10 seconds		T _L	300	°C
Maximum Temperature for Soldering @ Package Body for 10 seconds		T _{PKG}	260	
Operating Junction and Storage Temperature		T _j , T _{stg}	-55~+175	

*Drain current limited by maximum junction temperature



Thermal Data

Parameter	Symbol	Value	Unit
Thermal Resistance, Junction-to-case, max	R _{θJC}	3.6	°C/W
Thermal Resistance, Junction-to-ambient, max (Note 2)	R _{θJA}	58	°C/W

- Note : 1. The power dissipation P_D is based on T_{J(MAX)}=175 °C, using junction-to-case thermal resistance, and is more useful in setting the upper dissipation limit for cases where additional heatsinking is used.
2. The value of R_{θJA} is measured with the device mounted on 1 in² FR-4 board with 2 oz. copper, in a still air environment with T_A=25 °C. The power dissipation P_{DSM} is based on R_{θJA} and the maximum allowed junction temperature of 150 °C. The value in any given application depends on the user's specific board design, and the maximum temperature of 175 °C may be used if the PCB allows it.
3. Repetitive rating, pulse width limited by junction temperature T_{J(MAX)}=175 °C. Ratings are based on low frequency and low duty cycles to keep initial T_J=25 °C.

Characteristics (T_J=25°C, unless otherwise specified)

Symbol	Min.	Typ.	Max.	Unit	Test Conditions
Static					
BV _{DSS}	100	-	-	V	V _{GS} =0V, I _D =250μA
ΔBV _{DSS} /ΔT _j	-	0.1	-	V/°C	Reference to 25°C, I _D =250μA
V _{GS(th)}	2.0	-	4.0	V	V _{DS} = V _{GS} , I _D =250μA
*G _{FS}	-	16	-	S	V _{DS} =5V, I _D =18A
I _{GSS}	-	-	±100	nA	V _{GS} =±30V
I _{DSS}	-	-	1	μA	V _{DS} =80V, V _{GS} =0V
I _{DSS}	-	-	10		V _{DS} =80V, V _{GS} =0V, T _j =125°C
*R _{DS(ON)}	-	55.4	72	mΩ	V _{GS} =10V, I _D =18A
	-	56.1	80		V _{GS} =7V, I _D =12A
Dynamic					
*Q _g	-	11.2	-	nC	V _{DD} =80V, I _D =12A, V _{GS} =10V
*Q _{gs}	-	2.4	-		
*Q _{gd}	-	4.8	-		
*t _{d(ON)}	-	8.4	-	ns	V _{DD} =50V, I _D =12A, V _{GS} =10V, R _G =6Ω
*t _r	-	15	-		
*t _{d(OFF)}	-	19.6	-		
*t _f	-	9	-		
C _{iss}	-	453	-	pF	V _{GS} =0V, V _{DS} =30V, f=1MHz
C _{oss}	-	76.3	-		
C _{rss}	-	33.7	-		
Source-Drain Diode					
*I _S	-	-	18	A	I _S =18A, V _{GS} =0V
*I _{SM}	-	-	72		
*V _{SD}	-	0.89	1.3	V	V _{GS} =0V, I _F =18A, dI _F /dt=100A/μs
*t _{rr}	-	30	-	ns	
*Q _{rr}	-	45	-	nC	

*Pulse Test : Pulse Width ≤300μs, Duty Cycles ≤2%



Typical Characteristics

Typical Output Characteristics

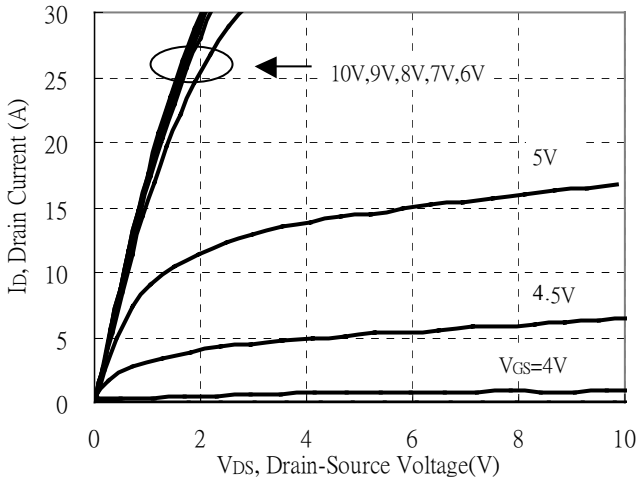

Brekdown Voltage vs Ambient Temperature

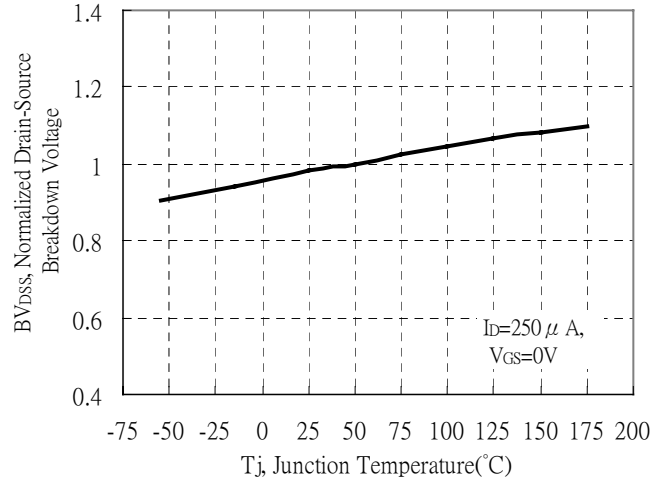

Static Drain-Source On-State resistance vs Drain Current

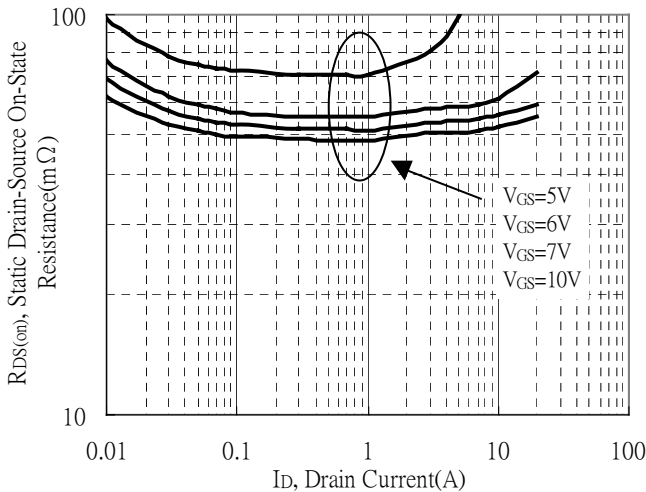

Reverse Drain Current vs Source-Drain Voltage

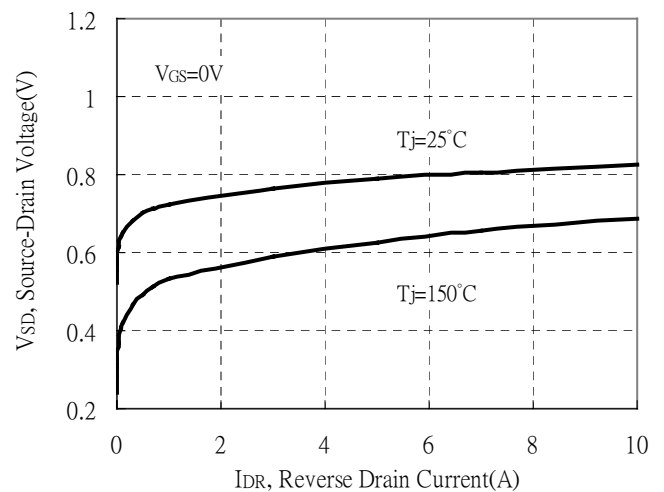

Static Drain-Source On-State Resistance vs Gate-Source Voltage

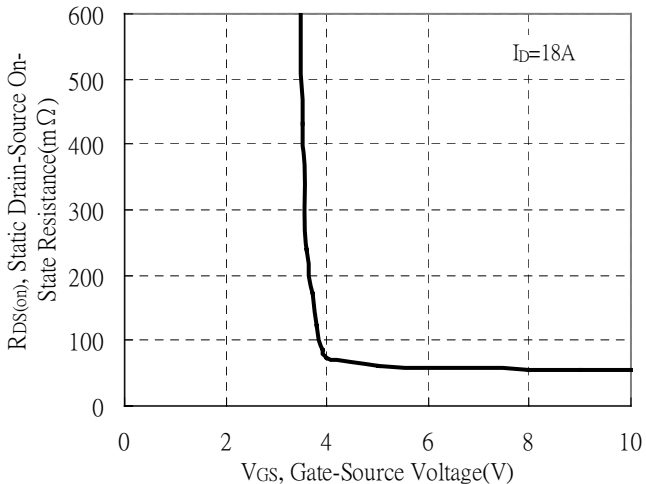

Drain-Source On-State Resistance vs Junction Temperature

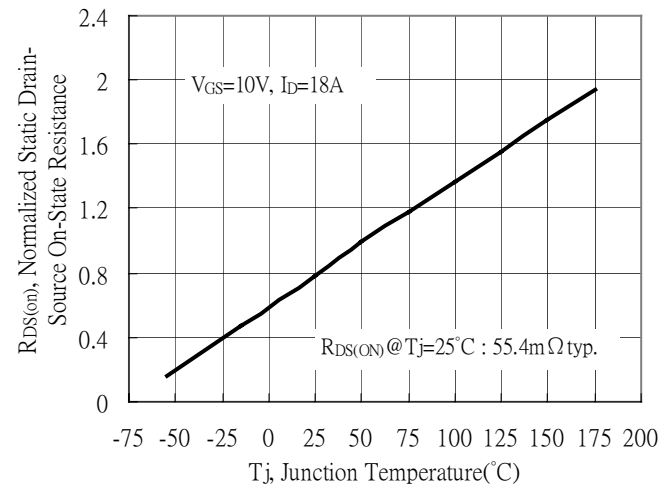

Typical Characteristics(Cont.)

Capacitance vs Drain-to-Source Voltage

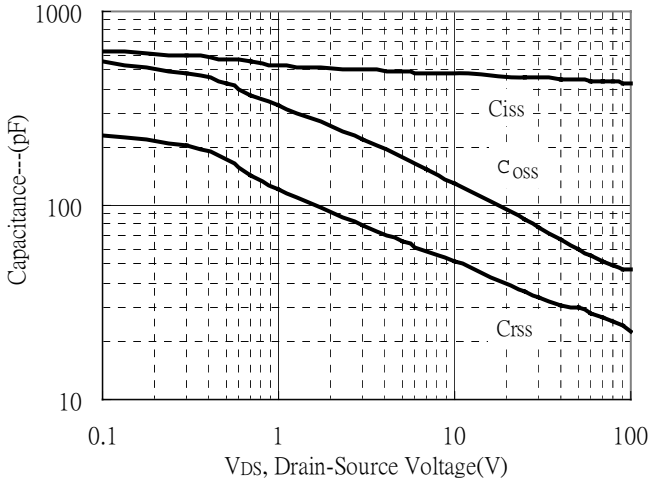

Threshold Voltage vs Junction Temperature

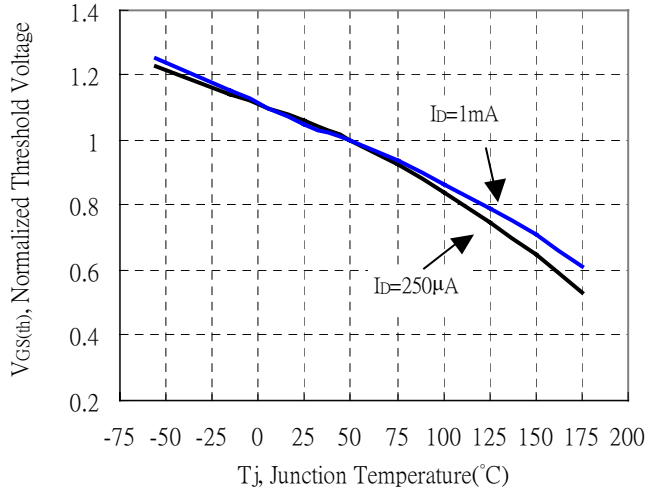

Forward Transfer Admittance vs Drain Current

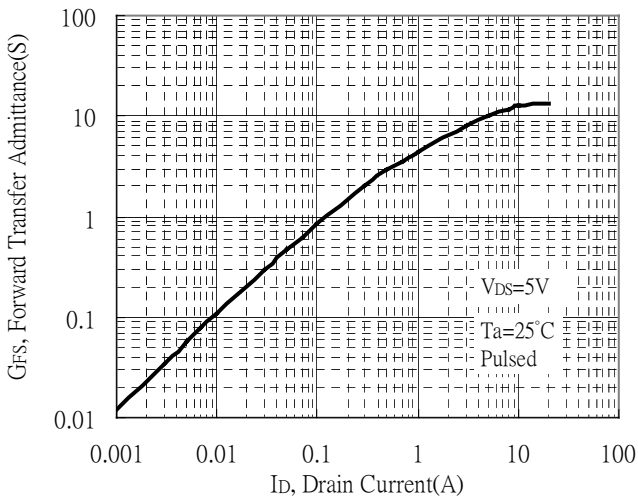

Gate Charge Characteristics

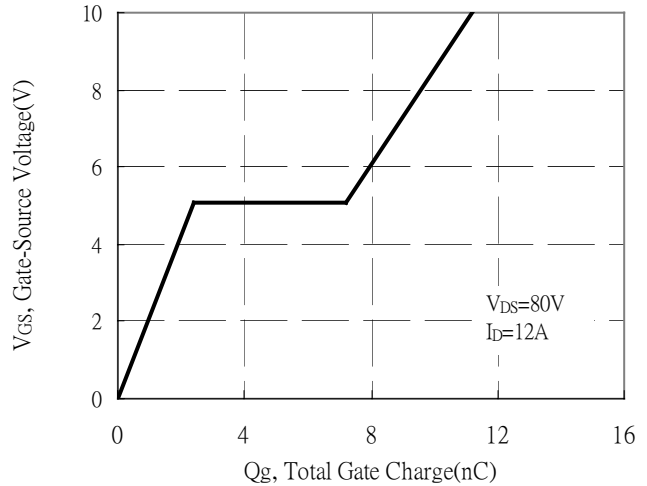

Maximum Safe Operating Area

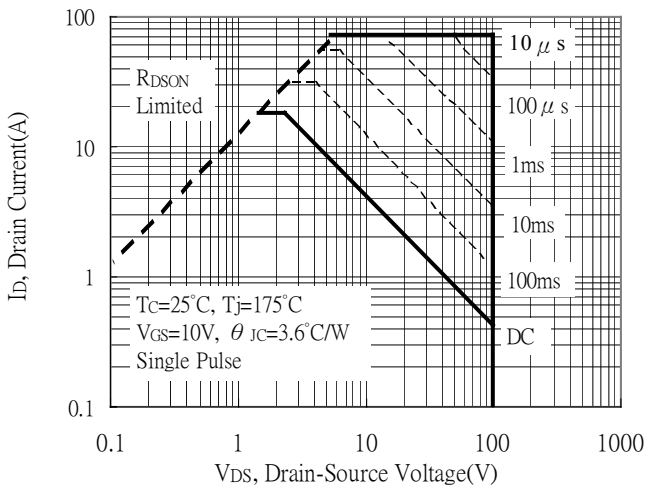

Maximum Drain Current vs Case Temperature

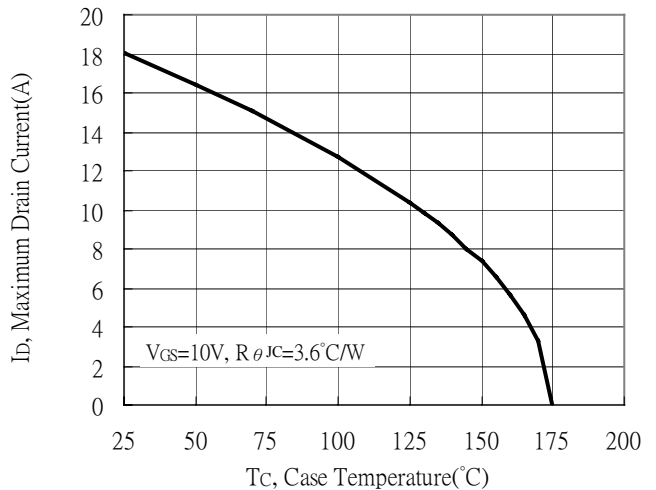



Typical Characteristics(Cont.)

Typical Transfer Characteristics

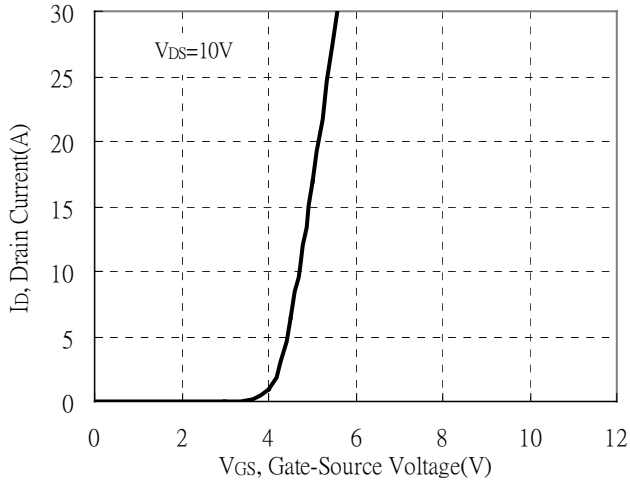

Single Pulse Power Rating, Junction to Case

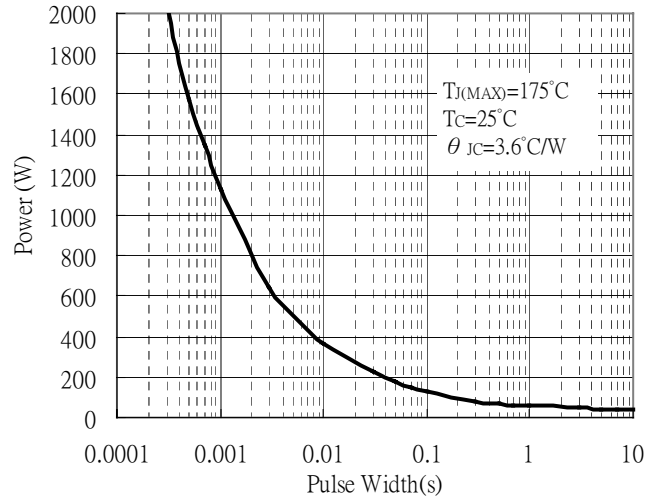

Transient Thermal Response Curves

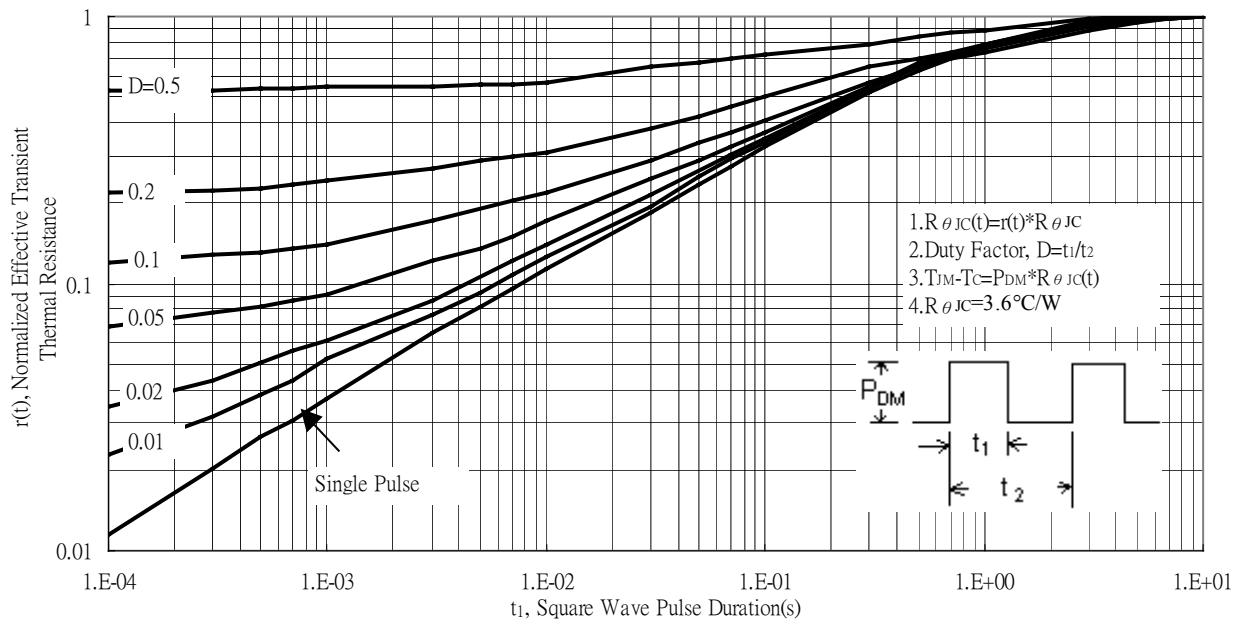

Recommended wave soldering condition

Product	Peak Temperature	Soldering Time
Pb-free devices	260 +0/-5 °C	5 +1/-1 seconds

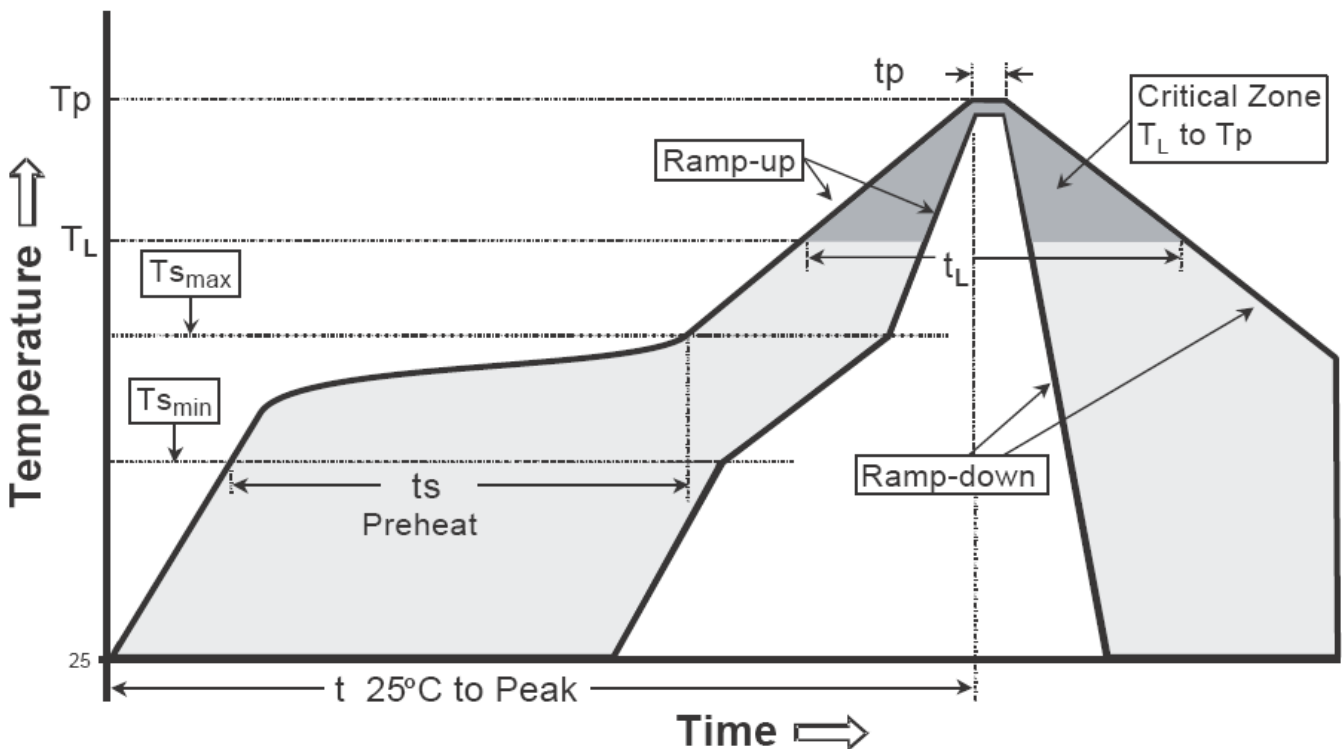
Recommended temperature profile for IR reflow

Profile feature	Sn-Pb eutectic Assembly	Pb-free Assembly
Average ramp-up rate (Tsmax to Tp)	3°C/second max.	3°C/second max.
Preheat		
-Temperature Min(Ts min)	100°C	150°C
-Temperature Max(Ts max)	150°C	200°C
-Time(ts min to ts max)	60-120 seconds	60-180 seconds
Time maintained above:		
-Temperature (TL)	183°C	217°C
- Time (tL)	60-150 seconds	60-150 seconds
Peak Temperature(TP)	240 +0/-5 °C	260 +0/-5 °C
Time within 5°C of actual peak temperature(tp)	10-30 seconds	20-40 seconds
Ramp down rate	6°C/second max.	6°C/second max.
Time 25 °C to peak temperature	6 minutes max.	8 minutes max.

Note : All temperatures refer to topside of the package, measured on the package body surface.

TO-220FP Dimension

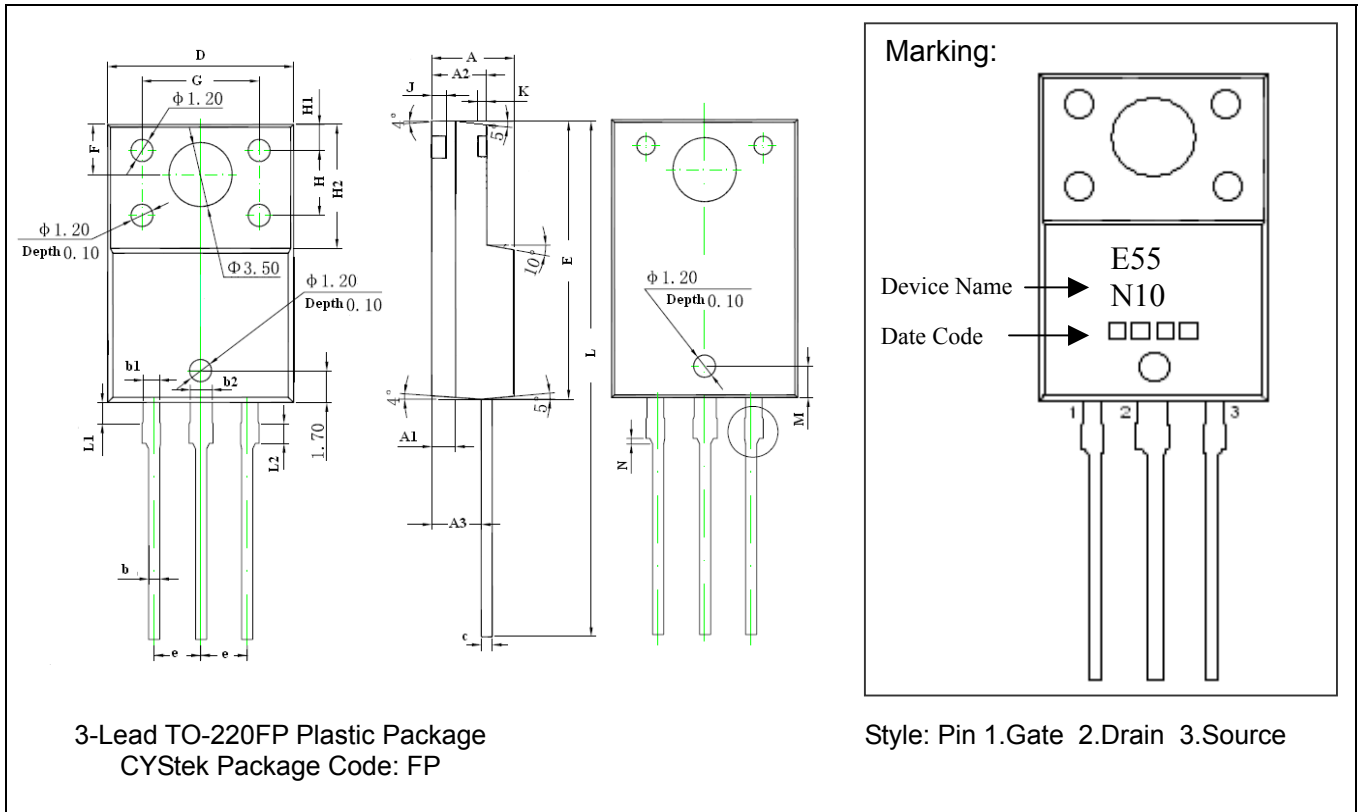

*Typical

DIM	Inches		Millimeters		DIM	Inches		Millimeters	
	Min.	Max.	Min.	Max.		Min.	Max.	Min.	Max.
A	0.171	0.183	4.35	4.65	G	0.246	0.258	6.25	6.55
A1	0.051 REF		1.300 REF		H	0.138 REF		3.50 REF	
A2	0.112	0.124	2.85	3.15	H1	0.055 REF		1.40 REF	
A3	0.102	0.110	2.60	2.80	H2	0.256	0.272	6.50	6.90
b	0.020	0.030	0.50	0.75	J	0.031 REF		0.80 REF	
b1	0.031	0.041	0.80	1.05	K	0.020		0.50 REF	
b2	0.047 REF		1.20 REF		L	1.102	1.118	28.00	28.40
c	0.020	0.030	0.500	0.750	L1	0.043	0.051	1.10	1.30
D	0.396	0.404	10.06	10.26	L2	0.036	0.043	0.92	1.08
E	0.583	0.598	14.80	15.20	M	0.067 REF		1.70 REF	
e	0.100 *		2.54*		N	0.012 REF		0.30 REF	
F	0.106 REF		2.70 REF						

- Notes: 1.Controlling dimension: millimeters.
 2.Maximum lead thickness includes lead finish thickness, and minimum lead thickness is the minimum thickness of base material.
 3.If there is any question with packing specification or packing method, please contact your local CYStek sales office.

Material:

- Lead: Pure tin plated.
- Mold Compound: Epoxy resin family, flammability solid burning class: UL94V-0.

Important Notice:

- All rights are reserved. Reproduction in whole or in part is prohibited without the prior written approval of CYStek.
- CYStek reserves the right to make changes to its products without notice.
- CYStek **semiconductor products are not warranted to be suitable for use in Life-Support Applications, or systems.**
- CYStek assumes no liability for any consequence of customer product design, infringement of patents, or application assistance.