

To our customers,

Old Company Name in Catalogs and Other Documents

On April 1st, 2010, NEC Electronics Corporation merged with Renesas Technology Corporation, and Renesas Electronics Corporation took over all the business of both companies. Therefore, although the old company name remains in this document, it is a valid Renesas Electronics document. We appreciate your understanding.

Renesas Electronics website: <http://www.renesas.com>

April 1st, 2010
Renesas Electronics Corporation

Issued by: Renesas Electronics Corporation (<http://www.renesas.com>)

Send any inquiries to <http://www.renesas.com/inquiry>.

Not recommended
for new design

Notice

1. All information included in this document is current as of the date this document is issued. Such information, however, is subject to change without any prior notice. Before purchasing or using any Renesas Electronics products listed herein, please confirm the latest product information with a Renesas Electronics sales office. Also, please pay regular and careful attention to additional and different information to be disclosed by Renesas Electronics such as that disclosed through our website.
2. Renesas Electronics does not assume any liability for infringement of patents, copyrights, or other intellectual property rights of third parties by or arising from the use of Renesas Electronics products or technical information described in this document. No license, express, implied or otherwise, is granted hereby under any patents, copyrights or other intellectual property rights of Renesas Electronics or others.
3. You should not alter, modify, copy, or otherwise misappropriate any Renesas Electronics product, whether in whole or in part.
4. Descriptions of circuits, software and other related information in this document are provided only to illustrate the operation of semiconductor products and application examples. You are fully responsible for the incorporation of these circuits, software, and information in the design of your equipment. Renesas Electronics assumes no responsibility for any losses incurred by you or third parties arising from the use of these circuits, software, or information.
5. When exporting the products or technology described in this document, you should comply with the applicable export control laws and regulations and follow the procedures required by such laws and regulations. You should not use Renesas Electronics products or the technology described in this document for any purpose relating to military applications or use by the military, including but not limited to the development of weapons of mass destruction. Renesas Electronics products and technology may not be used for or incorporated into any products or systems whose manufacture, use, or sale is prohibited under any applicable domestic or foreign laws or regulations.
6. Renesas Electronics has used reasonable care in preparing the information included in this document, but Renesas Electronics does not warrant that such information is error free. Renesas Electronics assumes no liability whatsoever for any damages incurred by you resulting from errors in or omissions from the information included herein.
7. Renesas Electronics products are classified according to the following three quality grades: “Standard”, “High Quality”, and “Specific”. The recommended applications for each Renesas Electronics product depends on the product’s quality grade, as indicated below. You must check the quality grade of each Renesas Electronics product before using it in a particular application. You may not use any Renesas Electronics product for any application categorized as “Specific” without the prior written consent of Renesas Electronics. Further, you may not use any Renesas Electronics product for any application for which it is not intended without the prior written consent of Renesas Electronics. Renesas Electronics shall not be in any way liable for any damages or losses incurred by you or third parties arising from the use of any Renesas Electronics product for an application categorized as “Specific” or for which the product is not intended where you have failed to obtain the prior written consent of Renesas Electronics. The quality grade of each Renesas Electronics product is “Standard” unless otherwise expressly specified in a Renesas Electronics data sheets or data books, etc.
 - “Standard”: Computers; office equipment; communications equipment; test and measurement equipment; audio and visual equipment; home electronic appliances; machine tools; personal electronic equipment; and industrial robots.
 - “High Quality”: Transportation equipment (automobiles, trains, ships, etc.); traffic control systems; anti-disaster systems; anti-crime systems; safety equipment; and medical equipment not specifically designed for life support.
 - “Specific”: Aircraft; aerospace equipment; submersible repeaters; nuclear reactor control systems; medical equipment or systems for life support (e.g. artificial life support devices or systems), surgical implantations, or healthcare intervention (e.g. excision, etc.), and any other applications or purposes that pose a direct threat to human life.
8. You should use the Renesas Electronics products described in this document within the range specified by Renesas Electronics, especially with respect to the maximum rating, operating supply voltage range, movement power voltage range, heat radiation characteristics, installation and other product characteristics. Renesas Electronics shall have no liability for malfunctions or damages arising out of the use of Renesas Electronics products beyond such specified ranges.
9. Although Renesas Electronics endeavors to improve the quality and reliability of its products, semiconductor products have specific characteristics such as the occurrence of failure at a certain rate and malfunctions under certain use conditions. Further, Renesas Electronics products are not subject to radiation resistance design. Please be sure to implement safety measures to guard them against the possibility of physical injury, and injury or damage caused by fire in the event of the failure of a Renesas Electronics product, such as safety design for hardware and software including but not limited to redundancy, fire control and malfunction prevention, appropriate treatment for aging degradation or any other appropriate measures. Because the evaluation of microcomputer software alone is very difficult, please evaluate the safety of the final products or system manufactured by you.
10. Please contact a Renesas Electronics sales office for details as to environmental matters such as the environmental compatibility of each Renesas Electronics product. Please use Renesas Electronics products in compliance with all applicable laws and regulations that regulate the inclusion or use of controlled substances, including without limitation, the EU RoHS Directive. Renesas Electronics assumes no liability for damages or losses occurring as a result of your noncompliance with applicable laws and regulations.
11. This document may not be reproduced or duplicated, in any form, in whole or in part, without prior written consent of Renesas Electronics.
12. Please contact a Renesas Electronics sales office if you have any questions regarding the information contained in this document or Renesas Electronics products, or if you have any other inquiries.

(Note 1) “Renesas Electronics” as used in this document means Renesas Electronics Corporation and also includes its majority-owned subsidiaries.

(Note 2) “Renesas Electronics product(s)” means any product developed or manufactured by or for Renesas Electronics.

BIPOLAR ANALOG INTEGRATED CIRCUIT

μ PC29xxB Series

THREE-TERMINAL LOW DROPOUT VOLTAGE REGULATOR (OUTPUT CURRENT: 1.0 A)

DESCRIPTION

The μ PC29xxB series is a series of three-terminal low dropout voltage regulators with 1.0 A output current. This series is suitable for low voltage operated IC and has 4 output voltage types, 1.8 V, 2.5 V, 3.3 V and 5.0 V. Compared with the μ PC29xx and μ PC29xxA series, this series has improved output voltage tolerance ($V_o \pm 2\%$), quiescent current (1.8 mA TYP. ($I_o = 0$ A)), and short-circuit current.

FEATURES

- Output current capacity: 1.0 A
- Output voltage tolerance: $V_o \pm 2\%$ ($T_A = 25^\circ\text{C}$)
- Low quiescent current: 1.8 mA TYP. ($I_o = 0$ A)
- Low short-circuit current: 0.3 A TYP. (μ PC2918B), 0.6 A TYP. (μ PC2925B, μ PC2933B), 0.65 A TYP. (μ PC2905B)
- Low dropout voltage: $V_{DIF} = 0.6$ V MAX. ($I_o = 0.5$ A)
- On-chip inrush current protection circuit at the time of input voltage rising (when input voltage is low)
- On-chip over-current limiter
- On-chip thermal shut down circuit

APPLICATIONS

Digital TV, DVD, LCD Monitors, Printers, Audio, Air Conditioners, and other applications.

PIN CONFIGURATIONS (Marking Side)

Isolated TO-220 (MP-45G)

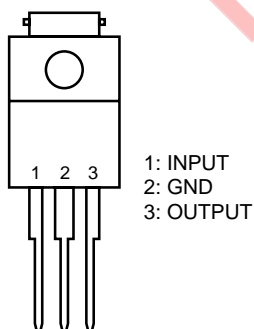

SC-64 (MP-3)

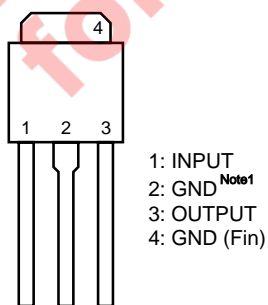

SC-63 (MP-3Z)

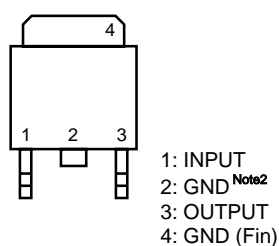

TO-252 (MP-3ZK)

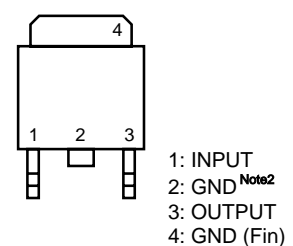

Notes 1. No.2 pin and No.4 fin are common GND.

2. No.2 pin is cut. No.2 pin and No.4 fin are common GND.

The information in this document is subject to change without notice. Before using this document, please confirm that this is the latest version.
Not all products and/or types are available in every country. Please check with an NEC Electronics sales representative for availability and additional information.

BLOCK DIAGRAM

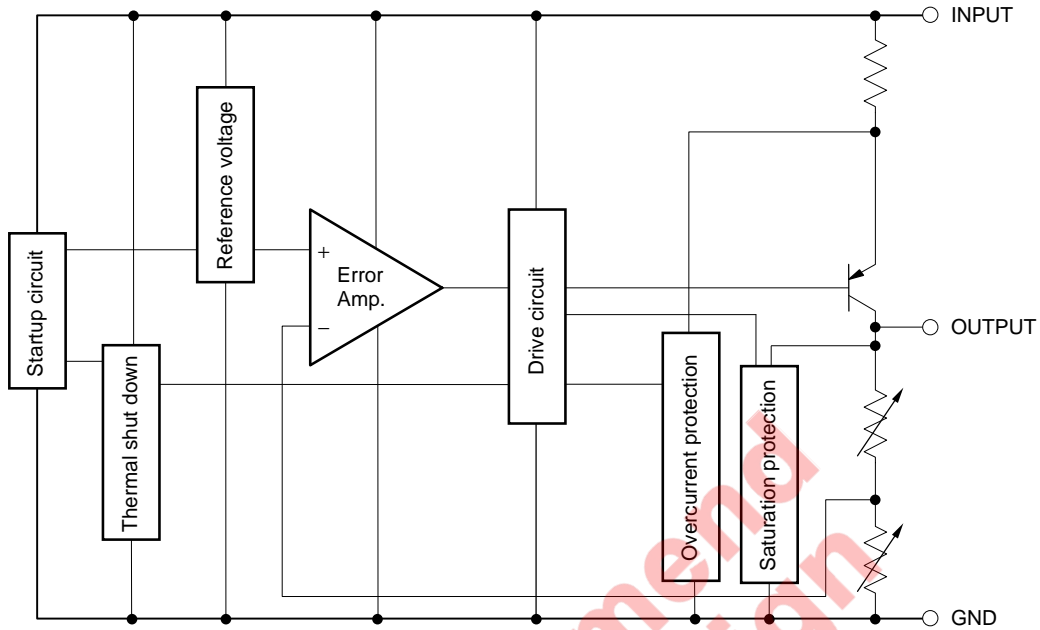

<R> **ORDERING INFORMATION**

Part Number	Package	Output Voltage	Marking
μPC2918BHF	Isolated TO-220 (MP-45G)	1.8 V	2918B
μPC2918BHB	SC-64 (MP-3)	1.8 V	2918B
μPC2918BT	SC-63 (MP-3Z)	1.8 V	2918B
μPC2918BT1D	TO-252 (MP-3ZK)	1.8 V	2918BD
μPC2925BHF	Isolated TO-220 (MP-45G)	2.5 V	2925B
μPC2925BHB	SC-64 (MP-3)	2.5 V	2925B
μPC2925BT	SC-63 (MP-3Z)	2.5 V	2925B
μPC2925BT1D	TO-252 (MP-3ZK)	2.5 V	2925BD
μPC2933BHF	Isolated TO-220 (MP-45G)	3.3 V	2933B
μPC2933BHB	SC-64 (MP-3)	3.3 V	2933B
μPC2933BT	SC-63 (MP-3Z)	3.3 V	2933B
μPC2933BT1D	TO-252 (MP-3ZK)	3.3 V	2933BD
μPC2905BHF	Isolated TO-220 (MP-45G)	5.0 V	2905B
μPC2905BHB	SC-64 (MP-3)	5.0 V	2905B
μPC2905BT	SC-63 (MP-3Z)	5.0 V	2905B
μPC2905BT1D	TO-252 (MP-3ZK)	5.0 V	2905BD

Remark Tape-packaged products have the symbol -E1, or -E2 suffixed to the part number. In Pb-free products, any of -AT, -AZ or -AY is added to the end of their part number. Refer to the following table for details.

Part Number ^{Note1}	Package	Package Type
μPC29xxBHF	Isolated TO-220 (MP-45G)	• Packed in envelop
μPC29xxBHF-AZ ^{Note2}	Isolated TO-220 (MP-45G)	• Packed in envelop
μPC29xxBHB	SC-64 (MP-3)	• Packed in envelop
μPC29xxBHB-AZ ^{Note2}	SC-64 (MP-3)	• Packed in envelop
μPC29xxBHB-AY ^{Note3}	SC-64 (MP-3)	• Packed in envelop
μPC29xxBT	SC-63 (MP-3Z)	• Packed in envelop
μPC29xxBT-AZ ^{Note2}	SC-63 (MP-3Z)	• Packed in envelop
μPC29xxBT-E1	SC-63 (MP-3Z)	• 16 mm wide embossed taping • Pin 1 on draw-out side • 2000 pcs/reel
μPC29xxBT-E1-AZ ^{Note2}	SC-63 (MP-3Z)	• 16 mm wide embossed taping • Pin 1 on draw-out side • 2000 pcs/reel
μPC29xxBT-E1-AY ^{Note3}	SC-63 (MP-3Z)	• 16 mm wide embossed taping • Pin 1 on draw-out side • 2000 pcs/reel
μPC29xxBT-E2	SC-63 (MP-3Z)	• 16 mm wide embossed taping • Pin 1 at take-up side • 2000 pcs/reel
μPC29xxBT-E2-AZ ^{Note2}	SC-63 (MP-3Z)	• 16 mm wide embossed taping • Pin 1 at take-up side • 2000 pcs/reel
μPC29xxBT-E2-AY ^{Note3}	SC-63 (MP-3Z)	• 16 mm wide embossed taping • Pin 1 at take-up side • 2000 pcs/reel
μPC29xxBT1D-E1	TO-252 (MP-3ZK)	• 16 mm wide embossed taping • Pin 1 on draw-out side • 2500 pcs/reel
μPC29xxBT1D-E1-AT ^{Note4}	TO-252 (MP-3ZK)	• 16 mm wide embossed taping • Pin 1 on draw-out side • 2500 pcs/reel
μPC29xxBT1D-E2	TO-252 (MP-3ZK)	• 16 mm wide embossed taping • Pin 1 at take-up side • 2500 pcs/reel
μPC29xxBT1D-E2-AT ^{Note4}	TO-252 (MP-3ZK)	• 16 mm wide embossed taping • Pin 1 at take-up side • 2500 pcs/reel

Notes 1. xx stands for symbols that indicate the output voltage.

2. Pb-free (This product does not contain Pb in the external electrode.)
3. Pb-free (This product does not contain Pb in the external electrode, Sn100% plating.)
4. Pb-free (This product does not contain Pb in the external electrode and other parts.)

ABSOLUTE MAXIMUM RATINGS (T_A = 25°C, unless otherwise specified)

Parameter	Symbol	Rating		Unit
		μPC29xxBHF	μPC29xxBHB, μPC29xxBT, μPC29xxBT1D	
Input Voltage	V _{IN}	-0.3 to +16.0		V
Internal Power Dissipation (T _C = 25°C) ^{Note}	P _T	15	10	W
Operating Ambient Temperature	T _A	-40 to +85		°C
Operating Junction Temperature	T _J	-40 to +150		°C
Storage Temperature	T _{stg}	-55 to +150		°C
Thermal Resistance (junction to case)	R _{th(J-C)}	7	12.5	°C/W
Thermal Resistance (junction to ambient)	R _{th(J-A)}	65	125	°C/W

Note Internally limited. When the operating junction temperature rises above 150°C, the internal circuit shuts down the output voltage.

Caution Product quality may suffer if the absolute maximum rating is exceeded even momentarily for any parameter. That is, the absolute maximum ratings are rated values at which the product is on the verge of suffering physical damage, and therefore the product must be used under conditions that ensure that the absolute maximum ratings are not exceeded.

TYPICAL CONNECTION

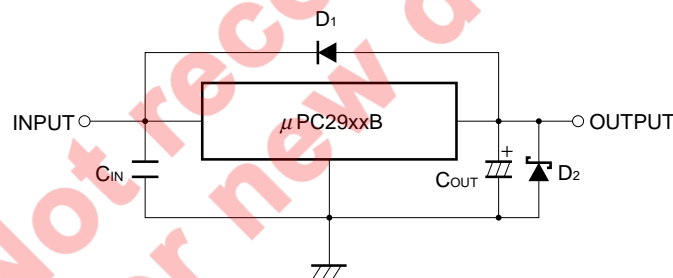

C_{IN} : 0.1 μF or higher. Be sure to connect C_{IN} to prevent parasitic oscillation. Set this value according to the length of the line between the regulator and the INPUT pin. Use of a film capacitor or other capacitor with first-rate voltage and temperature characteristics is recommended. If using a laminated ceramic capacitor, it is necessary to ensure that C_{IN} is 0.1 μF or higher for the voltage and temperature range to be used.

C_{OUT}: 10 μF or higher. Be sure to connect C_{OUT} to prevent oscillation and improve excessive load regulation. Place C_{IN} and C_{OUT} as close as possible to the IC pins (within 1 to 2 cm). Also, use an electrolytic capacitor with low impedance characteristics if considering use at sub-zero temperatures.

D₁ : If the OUTPUT pin has a higher voltage than the INPUT pin, connect a diode.

D₂ : If the OUTPUT pin has a lower voltage than the GND pin, connect a Schottky barrier diode.

Caution Make sure that no voltage is applied to the OUTPUT pin from external.

RECOMMENDED OPERATING CONDITIONS

Parameter	Symbol	Type Number	MIN.	TYP.	MAX.	Unit
Input Voltage	V _{IN}	μPC2918B	2.8		12.0	V
		μPC2925B	3.5		12.0	V
		μPC2933B	4.3		12.0	V
		μPC2905B	6.0		12.0	V
Output Current	I _o	All	0		1.0	A
Operating Ambient Temperature	T _A	All	-40		+85	°C
Operating Junction Temperature	T _J	All	-40		+125	°C

Caution Use of conditions exceeding the above-listed recommended operating conditions is not a problem as long as the absolute maximum ratings are not exceeded. However, since the use of such conditions diminishes the margin of safety, careful evaluation is required before such conditions are used.

ELECTRICAL CHARACTERISTICS

μPC2918B (T_J = 25°C, V_{IN} = 2.8 V, I_o = 0.5 A, C_{IN} = 0.1 μF, C_{OUT} = 10 μF, unless otherwise specified)

Parameter	Symbol	Conditions	MIN.	TYP.	MAX.	Unit
Output Voltage	V _{O1}		1.764	1.8	1.836	V
	V _{O2}	2.8 V ≤ V _{IN} ≤ 12 V, 0 A ≤ I _o ≤ 1 A	(1.746)	–	(1.854)	V
Line Regulation	REG _{IN}	2.8 V ≤ V _{IN} ≤ 12 V	–	4.0	25.0	mV
Load Regulation	REG _L	0 A ≤ I _o ≤ 1 A	–	3.5	30.0	mV
Quiescent Current	I _{BIAS}	I _o = 0 A	–	1.8	4.0	mA
		I _o = 0.5 A	–	18.0	(30.0)	mA
Startup Quiescent Current	I _{BIAS(S)}	V _{IN} = 1.7 V, I _o = 0 A	–	1.0	30.0	mA
		V _{IN} = 2.4 V, I _o = 1 A	–	–	(80.0)	mA
Quiescent Current Change	ΔI _{BIAS}	2.8 V ≤ V _{IN} ≤ 12 V	–	(3.0)	(15.0)	mA
Output Noise Voltage	V _n	10 Hz ≤ f ≤ 100 kHz	–	50.0	–	μV _{r.m.s.}
Ripple Rejection	R•R	f = 120 Hz, 2.8 V ≤ V _{IN} ≤ 3.8 V, I _o = 0.3 A	–	62	–	dB
Dropout Voltage	V _{DIF}	I _o = 0.5 A	–	0.3	0.6	V
		I _o = 1 A	–	(0.7)	–	V
Short Circuit Current	I _{Oshort}	V _{IN} = 2.8 V	(0.1)	0.3	(0.8)	A
		V _{IN} = 12 V	–	(0.4)	–	A
Peak Output Current	I _{Opeak}	V _{IN} = 2.8 V	1.0	1.3	(1.6)	A
		V _{IN} = 12 V	–	(1.1)	–	A
Temperature Coefficient of Output Voltage	ΔV _O /ΔT	0°C ≤ T _J ≤ 125°C, I _o = 5 mA	–	0.1	–	mV/°C

Remark Values in parentheses are product design values, and are thus provided as reference values.

μPC2925B (T_J = 25°C, V_{IN} = 3.5 V, I_O = 0.5 A, C_{IN} = 0.1 μF, C_{OUT} = 10 μF, unless otherwise specified)

Parameter	Symbol	Conditions	MIN.	TYP.	MAX.	Unit
Output Voltage	V _{O1}		2.45	2.5	2.55	V
	V _{O2}	3.5 V ≤ V _{IN} ≤ 12 V, 0 A ≤ I _O ≤ 1 A	(2.425)	–	(2.575)	V
Line Regulation	REG _{IN}	3.5 V ≤ V _{IN} ≤ 12 V	–	5.5	25.0	mV
Load Regulation	REG _L	0 A ≤ I _O ≤ 1 A	–	3.5	40.0	mV
Quiescent Current	I _{BIAS}	I _O = 0 A	–	1.8	4.0	mA
		I _O = 0.5 A	–	18.0	(30.0)	mA
Startup Quiescent Current	I _{BIAS(S)}	V _{IN} = 2.4 V, I _O = 0 A	–	11.0	30.0	mA
		V _{IN} = 3.1 V, I _O = 1 A	–	–	(80.0)	mA
Quiescent Current Change	ΔI _{BIAS}	3.5 V ≤ V _{IN} ≤ 12 V	–	(3.0)	(15.0)	mA
Output Noise Voltage	V _n	10 Hz ≤ f ≤ 100 kHz	–	62.0	–	μV _{r.m.s.}
Ripple Rejection	R•R	f = 120 Hz, 3.5 V ≤ V _{IN} ≤ 4.5 V, I _O = 0.3 A	–	60	–	dB
Dropout Voltage	V _{DIF}	I _O = 0.5 A	–	0.36	0.6	V
		I _O = 1 A	–	(0.7)	–	V
Short Circuit Current	I _{Oshort}	V _{IN} = 3.5 V	(0.1)	0.6	(0.8)	A
		V _{IN} = 12 V	–	(0.4)	–	A
Peak Output Current	I _{Opeak}	V _{IN} = 3.5 V	1.0	1.3	(1.6)	A
		V _{IN} = 12 V	–	(1.1)	–	A
Temperature Coefficient of Output Voltage	ΔV _O /ΔT	0°C ≤ T _J ≤ 125°C, I _O = 5 mA	–	0.2	–	mV/°C

Remark Values in parentheses are product design values, and are thus provided as reference values.

μPC2933B (T_J = 25°C, V_{IN} = 5.0 V, I_O = 0.5 A, C_{IN} = 0.1 μF, C_{OUT} = 10 μF, unless otherwise specified)

Parameter	Symbol	Conditions	MIN.	TYP.	MAX.	Unit
Output Voltage	V _{O1}		3.234	3.3	3.366	V
	V _{O2}	4.3 V ≤ V _{IN} ≤ 12 V, 0 A ≤ I _O ≤ 1 A	(3.201)	–	(3.399)	V
Line Regulation	REG _{IN}	4.3 V ≤ V _{IN} ≤ 12 V	–	6.0	25.0	mV
Load Regulation	REG _L	0 A ≤ I _O ≤ 1 A	–	4.2	50.0	mV
Quiescent Current	I _{BIAS}	I _O = 0 A	–	1.8	4.0	mA
		I _O = 0.5 A	–	18.0	(30.0)	mA
Startup Quiescent Current	I _{BIAS(S)}	V _{IN} = 3.1 V, I _O = 0 A	–	11.0	30.0	mA
		V _{IN} = 3.7 V, I _O = 1 A	–	–	(80.0)	mA
Quiescent Current Change	ΔI _{BIAS}	4.3 V ≤ V _{IN} ≤ 12 V	–	(3.0)	(15.0)	mA
Output Noise Voltage	V _n	10 Hz ≤ f ≤ 100 kHz	–	82.0	–	μV _{r.m.s.}
Ripple Rejection	R•R	f = 120 Hz, 4.3 V ≤ V _{IN} ≤ 5.3 V, I _O = 0.3 A	–	58	–	dB
Dropout Voltage	V _{DIF}	I _O = 0.5 A	–	0.36	0.6	V
		I _O = 1 A	–	(0.7)	–	V
Short Circuit Current	I _{Oshort}	V _{IN} = 5.0 V	(0.1)	0.6	(0.8)	A
		V _{IN} = 12 V	–	(0.4)	–	A
Peak Output Current	I _{Opeak}	V _{IN} = 5.0 V	1.0	1.5	(1.6)	A
		V _{IN} = 12 V	–	(1.1)	–	A
Temperature Coefficient of Output Voltage	ΔV _O /ΔT	0°C ≤ T _J ≤ 125°C, I _O = 5 mA	–	0.4	–	mV/°C

Remark Values in parentheses are product design values, and are thus provided as reference values.

μPC2905B (T_J = 25°C, V_{IN} = 6.0 V, I_O = 0.5 A, C_{IN} = 0.1 μF, C_{OUT} = 10 μF, unless otherwise specified)

Parameter	Symbol	Conditions	MIN.	TYP.	MAX.	Unit
Output Voltage	V _{O1}		4.90	5.0	5.10	V
	V _{O2}	6.0 V ≤ V _{IN} ≤ 12 V, 0 A ≤ I _O ≤ 1 A	(4.85)	–	(5.15)	V
Line Regulation	REG _{IN}	6.0 V ≤ V _{IN} ≤ 12 V	–	6.5	25.0	mV
Load Regulation	REG _L	0 A ≤ I _O ≤ 1 A	–	5.0	80.0	mV
Quiescent Current	I _{BIAS}	I _O = 0 A	–	1.8	4.0	mA
		I _O = 0.5 A	–	18.0	(30.0)	mA
Startup Quiescent Current	I _{BIAS(S)}	V _{IN} = 4.8 V, I _O = 0 A	–	11.0	30.0	mA
		V _{IN} = 5.5 V, I _O = 1 A	–	–	(80.0)	mA
Quiescent Current Change	ΔI _{BIAS}	6.0 V ≤ V _{IN} ≤ 12 V	–	(3.0)	(15.0)	mA
Output Noise Voltage	V _n	10 Hz ≤ f ≤ 100 kHz	–	122.0	–	μV _{r.m.s.}
Ripple Rejection	R•R	f = 120 Hz, 6.0 V ≤ V _{IN} ≤ 7 V, I _O = 0.3 A	–	57	–	dB
Dropout Voltage	V _{DIF}	I _O = 0.5 A	–	0.38	0.6	V
		I _O = 1 A	–	(0.7)	–	V
Short Circuit Current	I _{Oshort}	V _{IN} = 6.5 V	(0.1)	0.65	(0.8)	A
		V _{IN} = 12 V	–	(0.4)	–	A
Peak Output Current	I _{Opeak}	V _{IN} = 6.5 V	1.0	1.5	(1.6)	A
		V _{IN} = 12 V	–	(1.1)	–	A
Temperature Coefficient of Output Voltage	ΔV _O /ΔT	0°C ≤ T _J ≤ 125°C, I _O = 5 mA	–	0.6	–	mV/°C

Remark Values in parentheses are product design values, and are thus provided as reference values.

Not recommended for new design

TYPICAL CHARACTERISTICS ($T_A = 25^\circ\text{C}$)

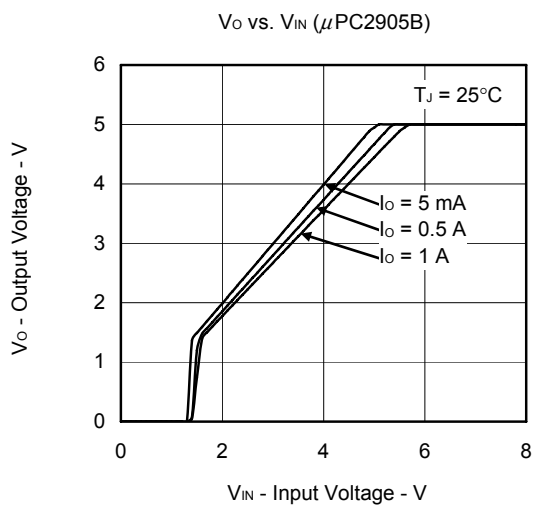
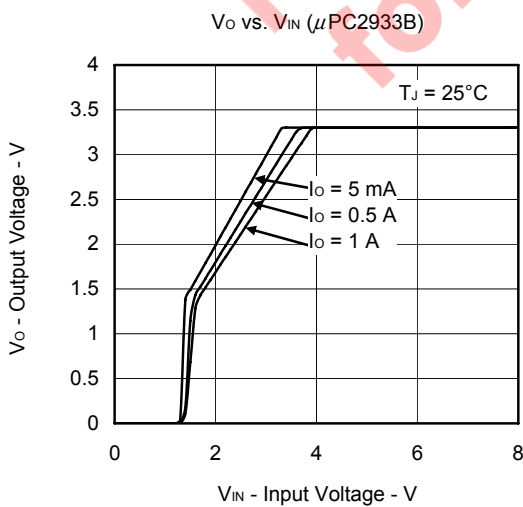
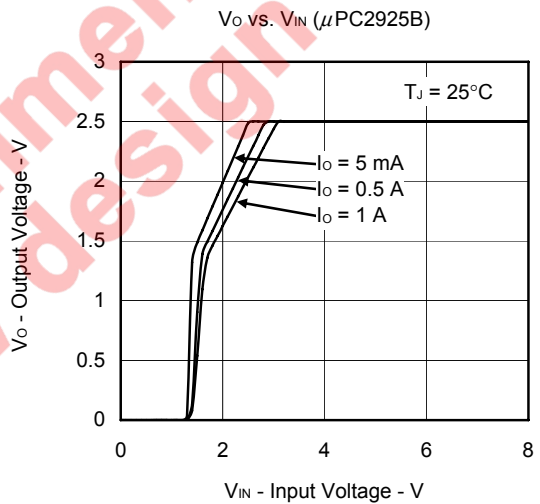
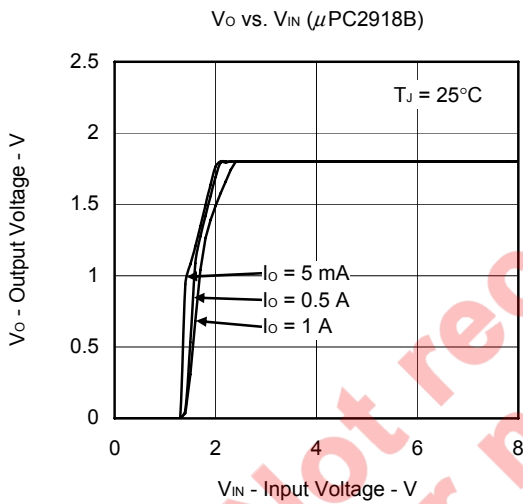
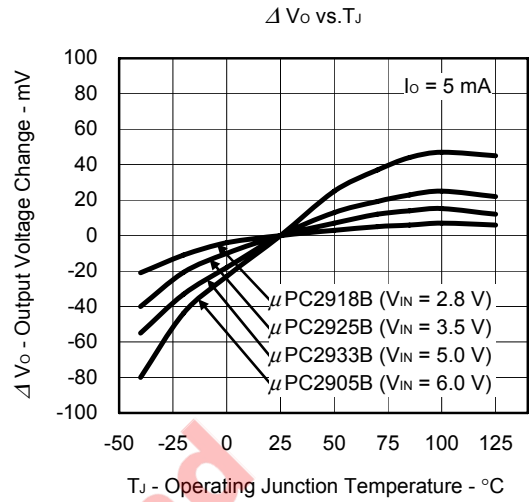
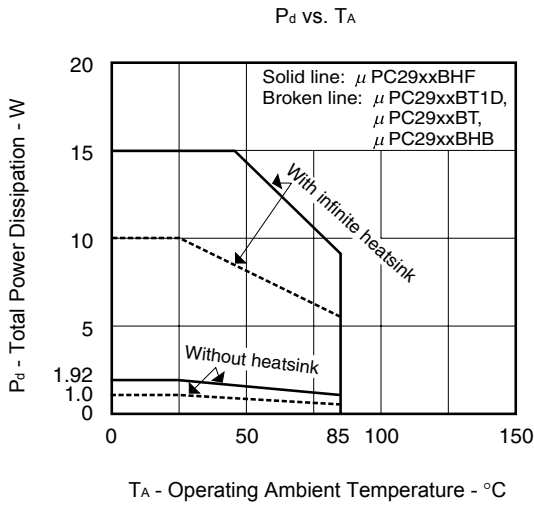

I_{BIAS} ($I_{BIAS(s)}$) vs. V_{IN} (μ PC2918B)

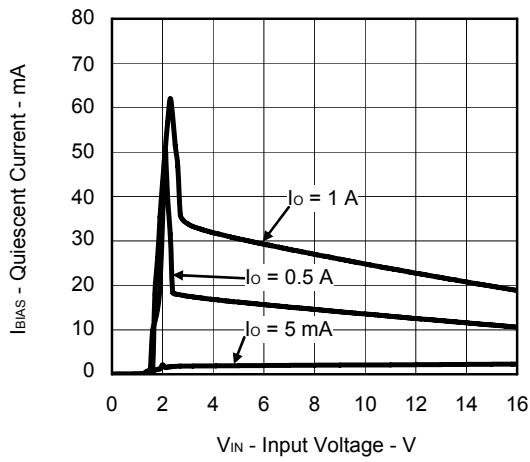

I_{BIAS} ($I_{BIAS(s)}$) vs. V_{IN} (μ PC2925B)

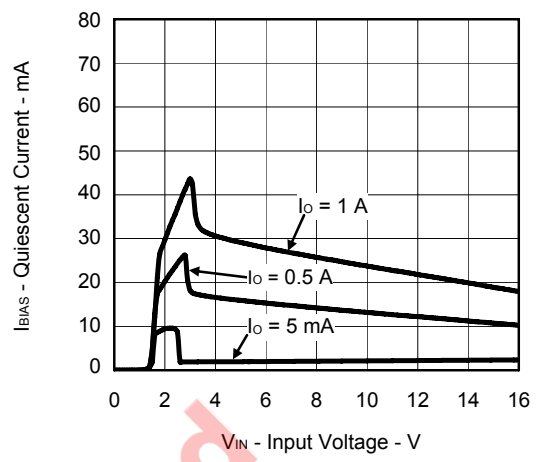

I_{BIAS} ($I_{BIAS(s)}$) vs. V_{IN} (μ PC2933B)

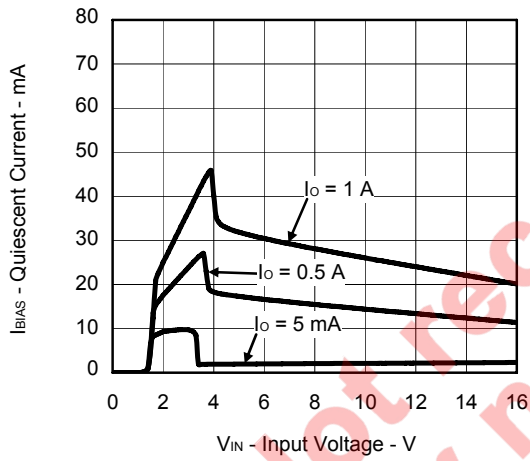

I_{BIAS} ($I_{BIAS(s)}$) vs. V_{IN} (μ PC2905B)

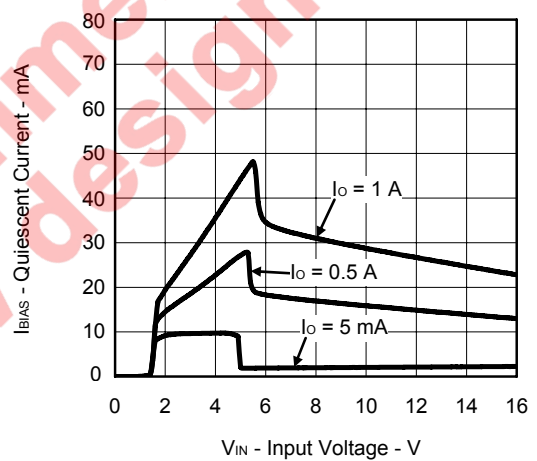

V_{DIF} vs. T_J

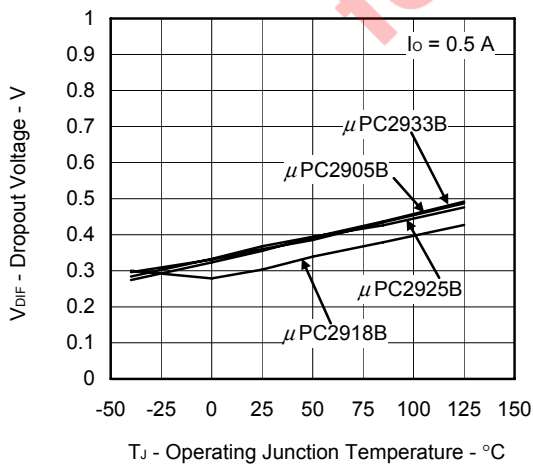

I_{Opeak} vs. V_{DIF}

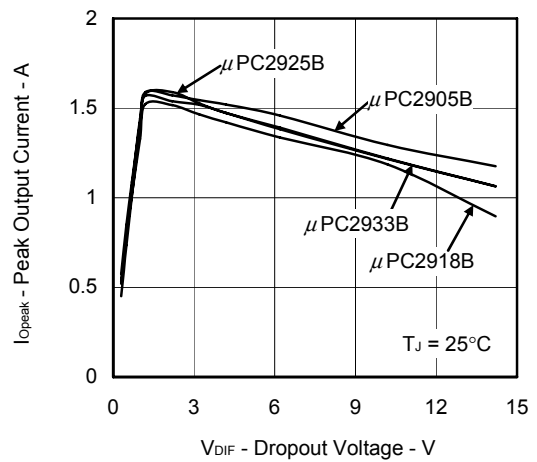

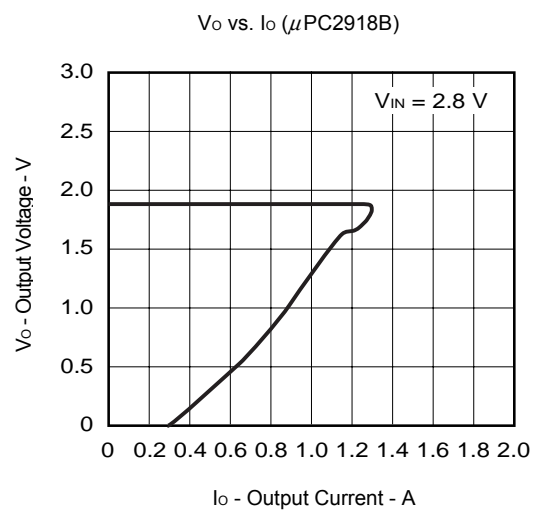
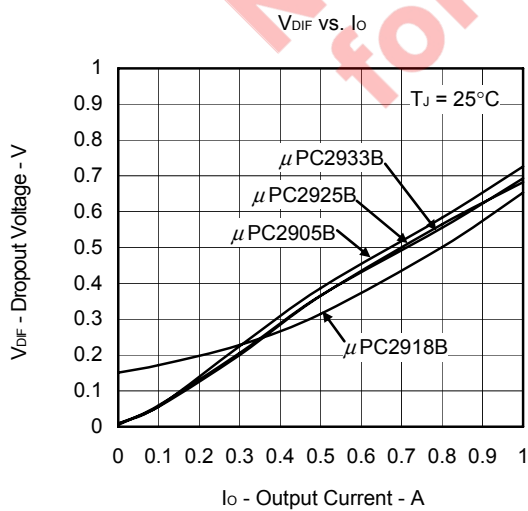
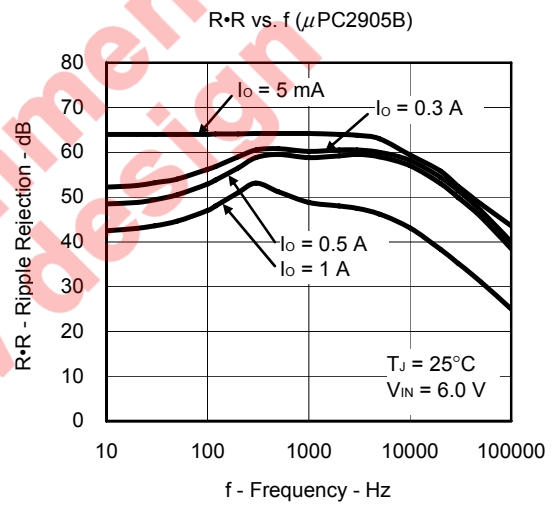
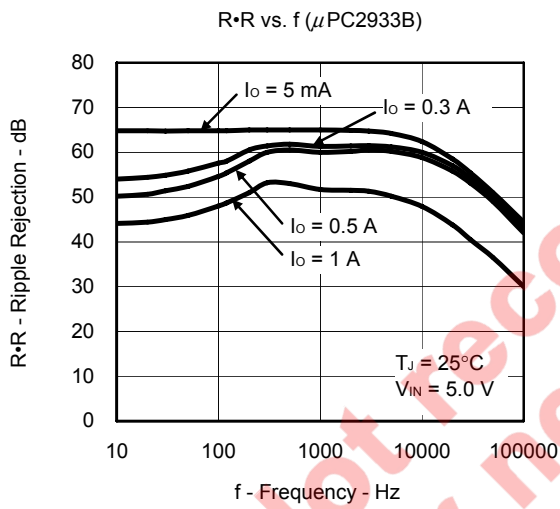
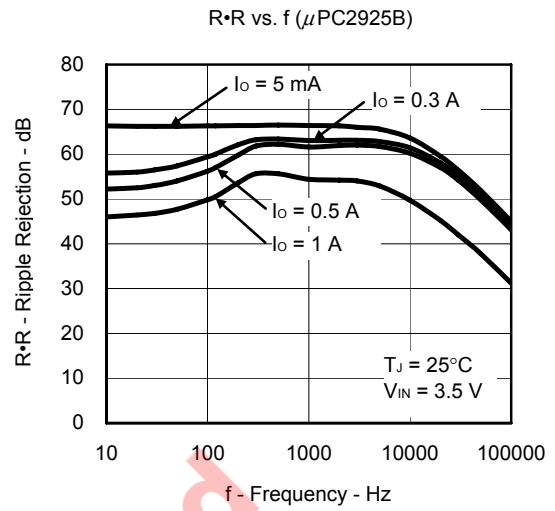
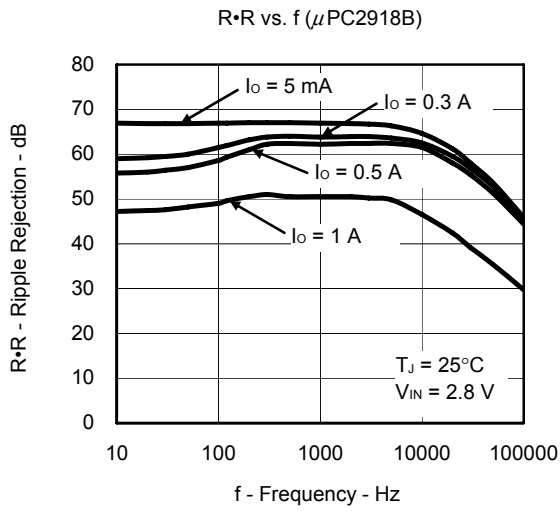

V_o vs. I_o (μ PC2925B)

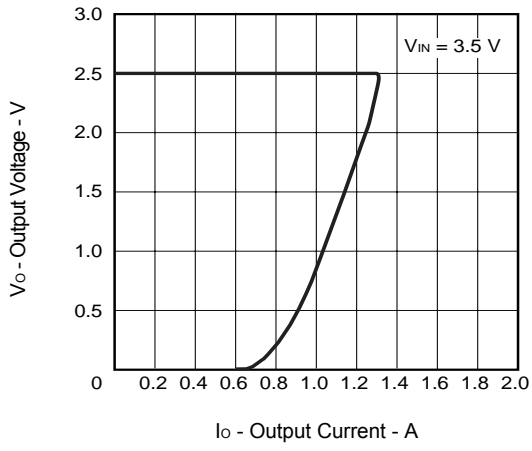

V_o vs. I_o (μ PC2933B)

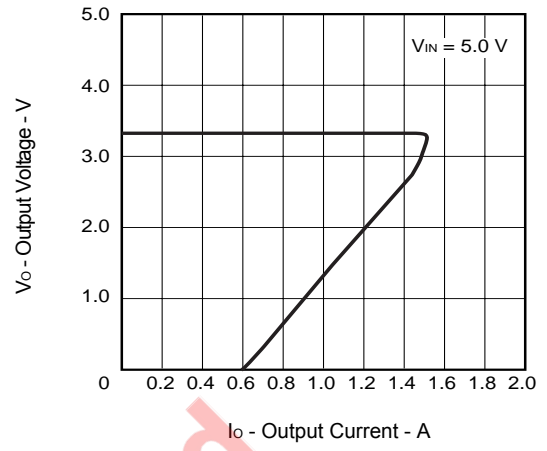

V_o vs. I_o (μ PC2905B)

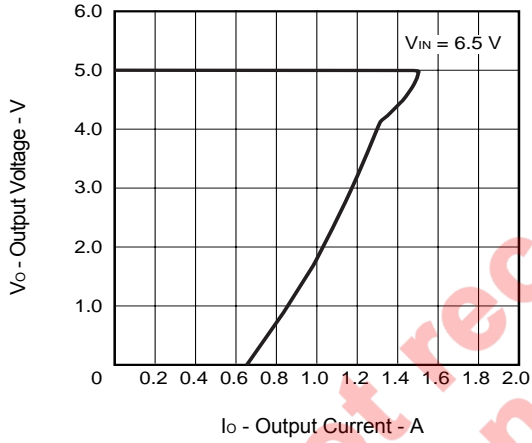

Not recommended for new design

PACKAGE DRAWINGS (Unit: mm)

μPC2918BHF, μPC2925BHF, μPC2933BHF, μPC2905BHF

3PIN PLASTIC SIP (MP-45G)

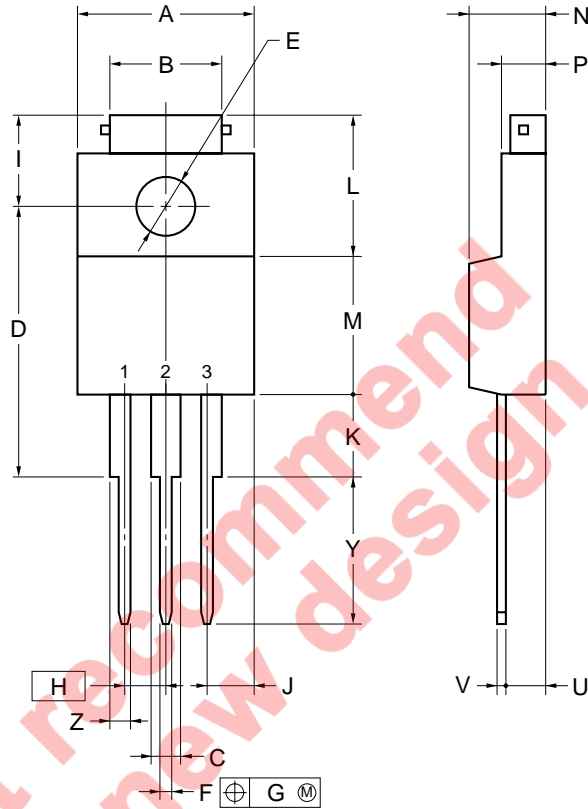

NOTE

Each lead centerline is located within 0.25 mm of its true position (T.P.) at maximum material condition.

ITEM	MILLIMETERS
A	10.0±0.2
B	7.0±0.2
C	1.50±0.2
D	17.0±0.3
E	φ3.3±0.2
F	0.75±0.10
G	0.25
H	2.54 (T.P.)
I	5.0±0.3
J	2.46±0.2
K	5.0±0.2
L	8.5±0.2
M	8.5±0.2
N	4.5±0.2
P	2.8±0.2
U	2.4±0.5
V	0.65±0.10
Y	8.9±0.7
Z	1.30±0.2

P3HF-254B-4

μ PC2918BHB, μ PC2925BHB, μ PC2933BHB, μ PC2905BHB

SC-64 (MP-3)

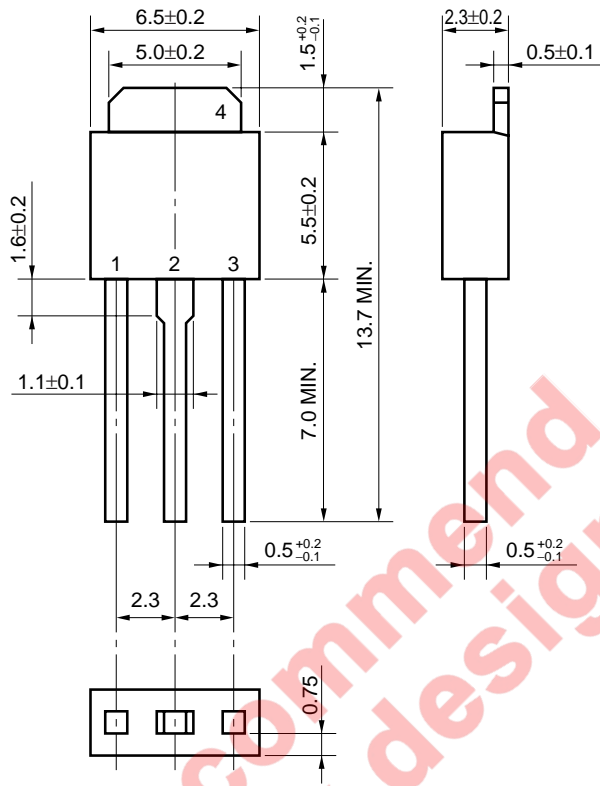

μ PC2918BT, μ PC2925BT, μ PC2933BT, μ PC2905BT

<R> SC-63 (MP-3Z) (Unit: mm)

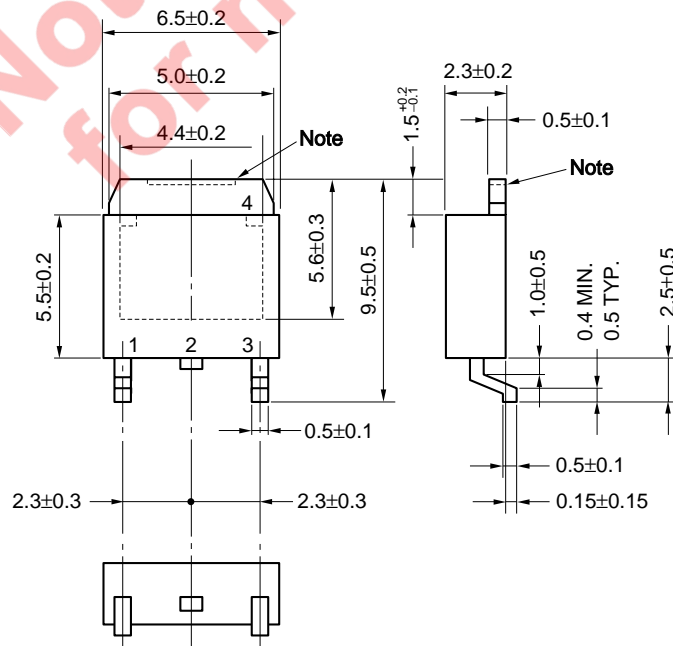

Note The depth of notch at the top of the fin is from 0 to 0.2 mm.

μPC2918BT1D, μPC2925BT1D, μPC2933BT1D, μPC2905BT1D

TO-252 (MP-3ZK)

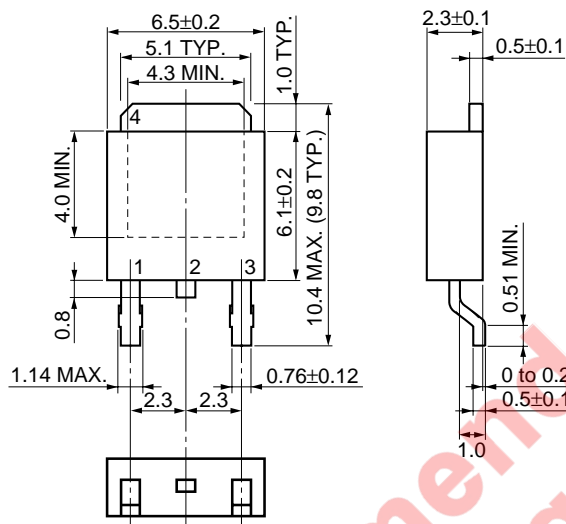

Not recommended for new design

<R> **RECOMMENDED MOUNTING CONDITIONS**

The μPC29xxB Series should be soldered and mounted under the following recommended conditions.

For soldering methods and conditions other than those recommended below, contact an NEC Electronics sales representative.

For technical information, see the following website.

Semiconductor Device Mount Manual (<http://www.necel.com/pkg/en/mount/index.html>)

Surface Mount Device

μPC29xxBT Series: SC-63 (MP-3Z)

μPC29xxBT1D Series: TO-252 (MP-3ZK)

Process	Conditions	Symbol
Infrared Ray Reflow	Peak temperature: 260°C or below (Package surface temperature), Reflow time: 60 seconds or less (at 220°C or higher), Maximum number of reflow processes: 3 times or less.	IR60-00-3
Vapor Phase Soldering	Peak temperature: 215°C or below (Package surface temperature), Reflow time: 40 seconds or less (at 200°C or higher), Maximum number of reflow processes: 3 times or less.	VP15-00-3
Partial Heating Method	Pin temperature: 350°C or below, Heat time: 3 seconds or less (Per each side of the device).	P350

μPC29xxBT-AZ Series^{Note1}, μPC29xxBT-AY Series^{Note2}: SC-63 (MP-3Z)

μPC29xxBT1D-AT Series^{Note3}: TO-252 (MP-3ZK)

Process	Conditions	Symbol
Infrared Ray Reflow	Peak temperature: 260°C or below (package surface temperature), Reflow time: 60 seconds or less (at 220°C or higher), Maximum number of reflows processes: 3 times or less.	IR60-00-3
Partial Heating Method	Pin temperature: 350°C or below, Heat time: 3 seconds or less (per each side of the device).	P350

Notes 1. Pb-free (This product does not contain Pb in the external electrode.)

2. Pb-free (This product does not contain Pb in the external electrode, Sn100% plating.)

3. Pb-free (This product does not contain Pb in the external electrode and other parts.)

Caution Apply only one kind of soldering condition to a device, except for "partial heating method", or the device will be damaged by heat stress.

Remark Flux: Rosin-based flux with low chlorine content (chlorine 0.2 Wt% or below) is recommended.

Type of Through-hole Device

μPC29xxBHF Series, μPC29xxBHF-AZ Series ^{Note1}: Isolated TO-220 (MP-45G)

μPC29xxBHB Series, μPC29xxBHB-AZ Series ^{Note1}, μPC29xxBHB-AY Series ^{Note2}: SC-64 (MP-3)

Process	Conditions	Symbol
Wave Soldering (only to leads)	Solder temperature: 260°C or below, Flow time: 10 seconds or less	WS60-00-1
Partial Heating Method	Pin temperature: 350°C or below, Heat time: 3 seconds or less (per each pin).	P350

Notes 1. Pb-free (This product does not contain Pb in the external electrode.)

2. Pb-free (This product does not contain Pb in the external electrode, Sn100% plating.)

Caution For through-hole device, the wave soldering process must be applied only to leads, and make sure that the package body does not get jet soldered.

REFERENCE DOCUMENTS

- USER'S MANUAL USAGE OF THREE TERMINAL REGULATORS Document No.G12702E
- <R> REVIEW OF QUALITY AND RELIABILITY HANDBOOK Document No.C12769E
- INFORMATION VOLTAGE REGULATOR OF SMD Document No.G11872E
- SEMICONDUCTOR DEVICE MOUNT MANUAL <http://www.necel.com/pkg/en/mount/index.html>

Not recommend
for new design

- **The information in this document is current as of August, 2007. The information is subject to change without notice. For actual design-in, refer to the latest publications of NEC Electronics data sheets or data books, etc., for the most up-to-date specifications of NEC Electronics products. Not all products and/or types are available in every country. Please check with an NEC Electronics sales representative for availability and additional information.**
- No part of this document may be copied or reproduced in any form or by any means without the prior written consent of NEC Electronics. NEC Electronics assumes no responsibility for any errors that may appear in this document.
- NEC Electronics does not assume any liability for infringement of patents, copyrights or other intellectual property rights of third parties by or arising from the use of NEC Electronics products listed in this document or any other liability arising from the use of such products. No license, express, implied or otherwise, is granted under any patents, copyrights or other intellectual property rights of NEC Electronics or others.
- Descriptions of circuits, software and other related information in this document are provided for illustrative purposes in semiconductor product operation and application examples. The incorporation of these circuits, software and information in the design of a customer's equipment shall be done under the full responsibility of the customer. NEC Electronics assumes no responsibility for any losses incurred by customers or third parties arising from the use of these circuits, software and information.
- While NEC Electronics endeavors to enhance the quality, reliability and safety of NEC Electronics products, customers agree and acknowledge that the possibility of defects thereof cannot be eliminated entirely. To minimize risks of damage to property or injury (including death) to persons arising from defects in NEC Electronics products, customers must incorporate sufficient safety measures in their design, such as redundancy, fire-containment and anti-failure features.
- NEC Electronics products are classified into the following three quality grades: "Standard", "Special" and "Specific".

The "Specific" quality grade applies only to NEC Electronics products developed based on a customer-designated "quality assurance program" for a specific application. The recommended applications of an NEC Electronics product depend on its quality grade, as indicated below. Customers must check the quality grade of each NEC Electronics product before using it in a particular application.

"Standard": Computers, office equipment, communications equipment, test and measurement equipment, audio and visual equipment, home electronic appliances, machine tools, personal electronic equipment and industrial robots.

"Special": Transportation equipment (automobiles, trains, ships, etc.), traffic control systems, anti-disaster systems, anti-crime systems, safety equipment and medical equipment (not specifically designed for life support).

"Specific": Aircraft, aerospace equipment, submersible repeaters, nuclear reactor control systems, life support systems and medical equipment for life support, etc.

The quality grade of NEC Electronics products is "Standard" unless otherwise expressly specified in NEC Electronics data sheets or data books, etc. If customers wish to use NEC Electronics products in applications not intended by NEC Electronics, they must contact an NEC Electronics sales representative in advance to determine NEC Electronics' willingness to support a given application.

(Note)

- (1) "NEC Electronics" as used in this statement means NEC Electronics Corporation and also includes its majority-owned subsidiaries.
- (2) "NEC Electronics products" means any product developed or manufactured by or for NEC Electronics (as defined above).