

RoHS Compliant Product

Description

The S5J2188 of positive, linear regulators feature low quiescent current (45µA typ.) with low dropout voltage, making them ideal for battery applications. Output voltage are set at the factory and trimmed to 1.5% accuracy. These rugged devices have both Thermal Shutdown and Current Fold-back to prevent device failure under the "Worst" of operating conditions. An additional feature is a "Power Good" detector, which pulls low when the output is out of regulation. The S5J2188 is stable with an output capacitance of 4.7µF or greater.

Features

- * Low Temperature Coefficient
- * Over-Temperature Shutdown
- * Adjustable Version
- * Very Low Dropout Voltage
- * High Accurate ±1.5%
- * Short Circuit Current Fold-back
- * Guaranteed 1.5A output
- * Current Limiting
- * Power-Saving Shutdown Mode

Applications

- * PC Peripherals
- * Wireless Devices
- * Portable Electronics
- * Battery Powered Widgets
- * Instrumentation

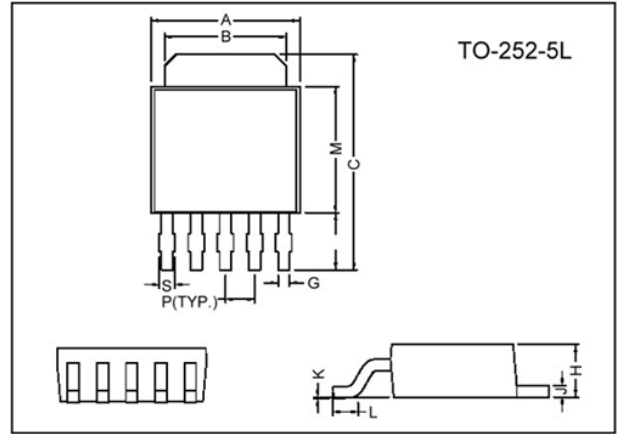

REF.	Millimeter		REF.	Millimeter	
	Min.	Max.		Min.	Max.
A	6.35	6.73	G	0.45	0.60
B	5.21	5.46	H	2.20	2.40
C	9.40	10.20	J	0.46	0.58
D	2.40	3.00	K	0	0.15
P	1.27 REF.		L	0.90	1.50
S	0.50	0.80	M	5.40	5.59

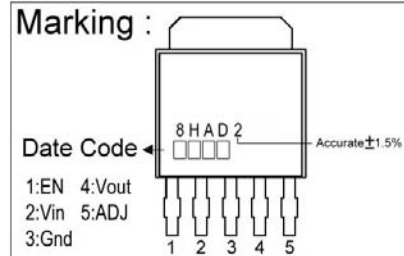

Functional Block Diagram

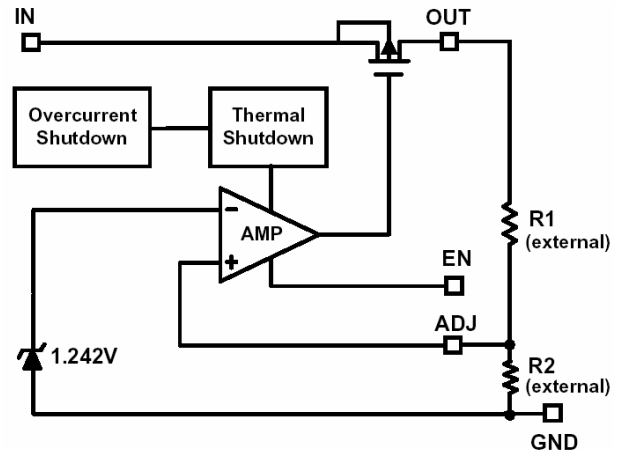

Typical Application Circuit

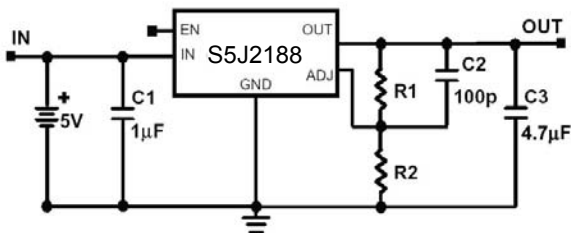

Absolute Maximum Ratings

Parameter	Symbol	Ratings	Unit
Input Voltage	V _{IN}	8	V
Output Current	I _{OUT}	P _D /(V _{IN} -V _O)	mA
Output Voltage	V _{OUT}	Gnd-0.3~V _{IN} +0.3	V
Operating Ambient Temperature	T _{opr}	-40~+85	°C
Junction Temperature	T _j	-40~+125	°C
Max. Junction Temperature	T _j Max.	150	°C
Power Dissipation (Δ T=100°C)	P _D	1.2	W
EDS Classification		B	

Electrical Characteristics V_{IN}=V_{OUT}(T)+2V, V_{EN}=V_{IN}, T_A=25°C unless otherwise noted

Parameter	Symbol	Condition	Min	Typ	Max	Unit	
Output Voltage	V _{OUT} (E) (Note1)	V _{EN} =V _{EH} min, I _O =1mA	-1.5%	V _{OUT} (T) (Note2)	1.5%	V	
Output Current	I _O	V _{OUT} >1.2V	1.5	-	-	A	
Current Limit	I _{LIM}	V _{OUT} >1.2V	1.5	2.0	-	A	
Load Regulation	REG _{LOAD}	I _O =1mA to 1.5A	-1	0.2	1	%	
Dropout Voltage	V _{DROPOUT}	I _O =1.5A V _O =V _{OUT} (E)-2%	1.5V<V _{OUT} (T)≤2.0V	-	-	1300	mV
			2.0V<V _{OUT} (T)≤2.8V	-	-	800	
			2.8V<V _{OUT} (T)	-	-	600	
Ground Pin Current	I _{GND}	I _O =1mA~1.5A	-	45	-	μA	
Line Regulation	REG _{LINE}	I _O =1mA V _{IN} =V _{OUT} V _{OUT} (T)+2	V _{OUT} (T)<2.0V	-0.15	-	0.15	%
			2.0V≤V _{OUT} (T)<4.0V	-0.1	0.02	0.1	
			4.0V≤V _{OUT} (T)	-0.4	-	0.4	
Input Voltage	V _{IN}		Note3	-	7	V	
Over Temperature Shutdown	OTS		-	150	-	°C	
Over Temperature Hysteresis	OTH		-	30	-	°C	
Output Voltage Temperature Coefficient	TC		-	30	-	ppm/°C	
Short Circuit Current	I _{SC}	V _{OUT} <0.4V	-	750	-	mA	
ADJ Input Bias Current	I _{ADJ}	V _{IN} =5V, V _{ADJ} =1.242V	-	1	-	μA	
Minimum Load Current	I _{Min}		1	-	-	mA	
ADJ Reference Voltage	V _{REF}		1.223	1.242	1.261	V	
Power Supply Rejection	PSRR	I _O =100mA C _O =4.7μF ceramic	f=1kHz	-	50	-	dB
			f=10kHz	-	20	-	
Output Voltage Noise	e _N	f=10Hz~100kHz I _O =10mA, C _O =4.7μF	-	30	-	μV _{rms}	
EN Input Threshold	V _{EH}	V _{IN} =2.7V to 7V	2.0	-	V _{IN}	V	
	V _{EL}	V _{IN} =2.7V to 7V	0	-	0.4	V	
EN Input Bias Current	I _{EH}	V _{IN} =7V	-	-	0.1	μA	
	I _{EL}	V _{EN} = 0V, V _{IN} =7V	-	-	0.5	μA	
Shutdown Supply Current	I _{SD}	V _{IN} =5V, V _{OUT} =0V, V _{EN} =0V	-	0.5	2	μA	

Note 1: V_{OUT}(E) =Effective Output Voltage (i.e. the output voltage when "V_{OUT}(T) + 2.0V" is provided at the V_{IN} pin while maintaining a certain I_{OUT} value).

2: V_{OUT}(T) =Specified Output Voltage

3: V_{IN}(MIN) =V_{OUT}+V_{DROPOUT}



Elektronische Bauelemente

S5J2188

1.5A CMOS

Low Dropout Voltage Regulator

Ordering Information(contd.)

Part Number	Marking	Output Voltage	Part Number	Marking	Output Voltage
S5J 2188-ADJ	8HAD2 XXXX	Adjustable			

Detailed Description

The S5J2188 of COMS regulator contains a PMOS pass transistor, voltage reference, error amplifier, over-current protection, and thermal shutdown.

The P-channel pass transistor receives data from the error amplifier, over-current shutdown, and thermal protection circuits. During normal operation, the error amplifier compares the output voltage to a precision reference. Over-current and Thermal shutdown circuits become active when the junction temperature exceeds 140°C, or the current exceeds 2.2A. During thermal shutdown, the output voltage remains low. Normal operation is restored when the junction temperature drops below 120°C.

The S5J2188 behaves like a current source when the load reaches 2.2A. However, if the load impedance drops below 0.3Ω, the current drops back to 600mA to prevent excessive power dissipation. Normal operation is restored when the load resistance exceeds 0.75Ω.

External Capacitors

The S5J2188 is stable with an output capacitance to ground of 4.7μF or greater. Ceramic capacitors have the lowest ESR, and will offer the best AC performance. Conversely, Aluminum Electrolytic capacitors exhibit the highest ESR, resulting in the poorest AC response. Unfortunately, large value ceramic capacitors are comparatively expensive. One option is to parallel a 0.1μF ceramic capacitor with a 10μF Aluminum Electrolytic. The benefit is low ESR, high capacitance, and low overall cost.

A second capacitor is recommended between the input and ground to stabilize Vin. The input capacitor should be at least 0.1μF to have a beneficial effect.

All capacitors should be placed in close proximity to the pins. A "Quiet" ground termination is desirable. This can be achieved with a "Star" connection.

Enable

When pulled low, the PMOS pass transistor shuts off, and all internal circuits are powered down. In this state, the quiescent current is less than 1μA. This pin behaves much like an electronic switch.

100kΩ resistor is necessary between VEN source and EN pin when VEN is higher than VIN.

(Note: there is no internal pull-up for EN PIN)

Adjustable Version

The adjustable version uses external feedback resistors to generate an output voltage anywhere from 1.5V to 5.0V. Vadj is trimmed to 1.242V and Vout is given by the equation:

$$V_{OUT} = V_{adj} * (1 + R1/R2)$$

Feedback resistors R1 and R2 should be high enough to keep quiescent current low, but increasing R1+R2 will reduce stability. In general, R1 and R2 in the 10's of kΩ will produce adequate stability, given reasonable layout precautions. To improve stability characteristics, keep parasitic on the ADJ pin to minimum, and lower R1 and R2 values.

Characteristics Curve

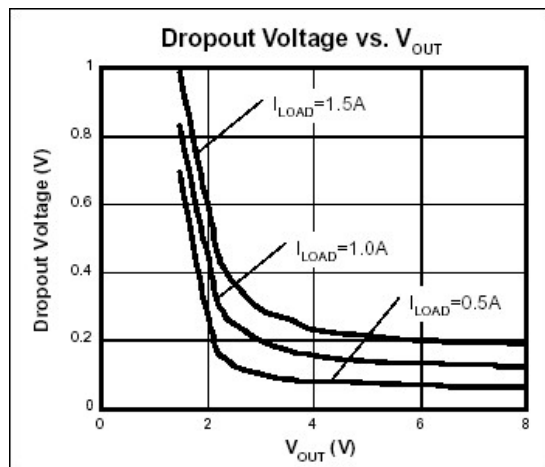
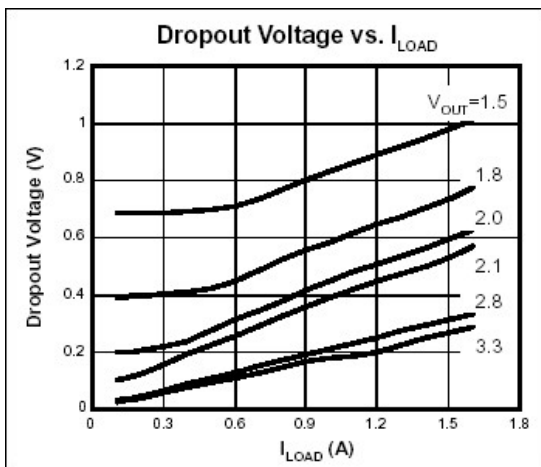
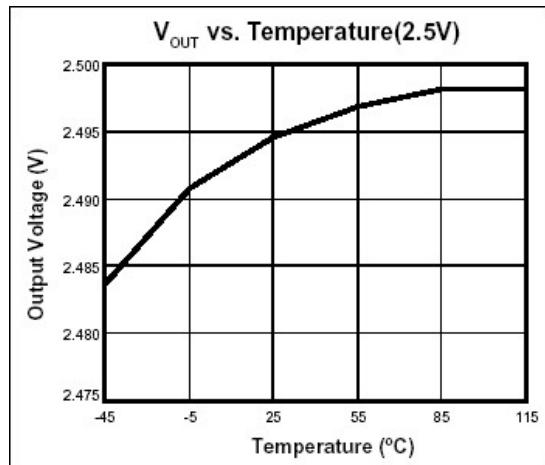
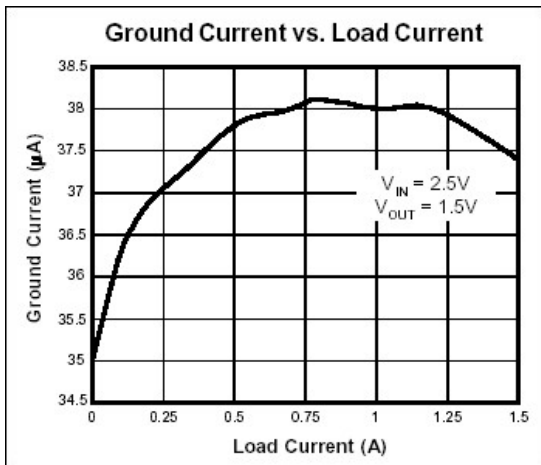
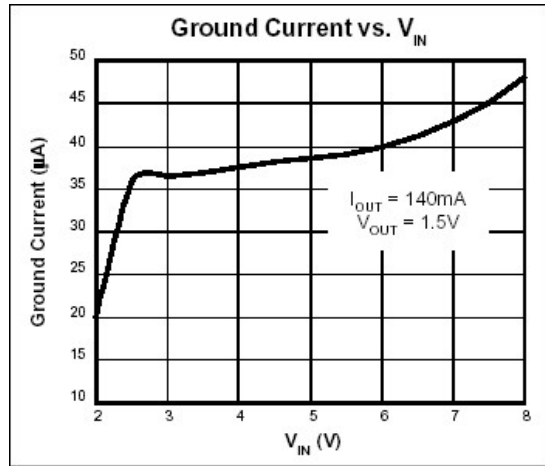
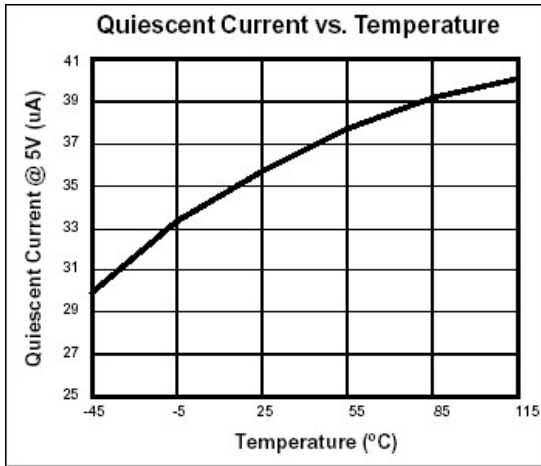

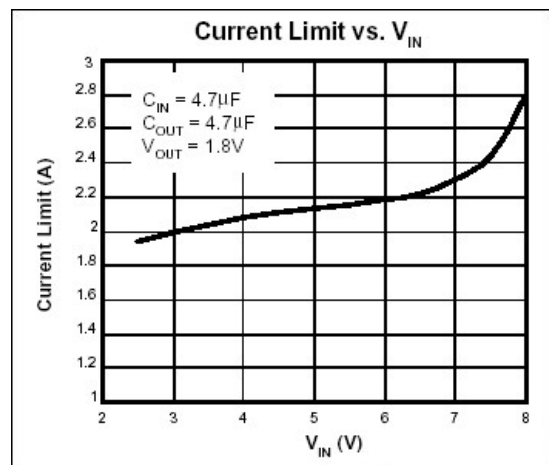
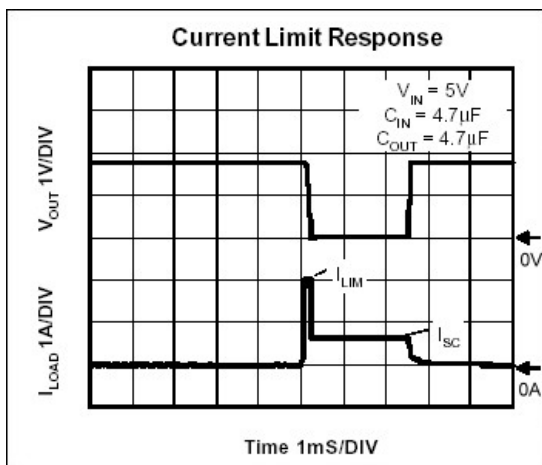
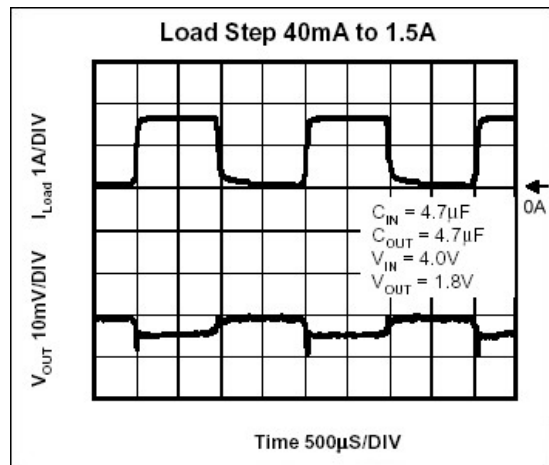
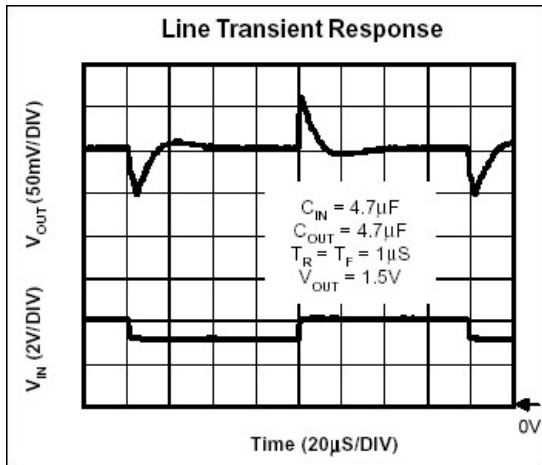
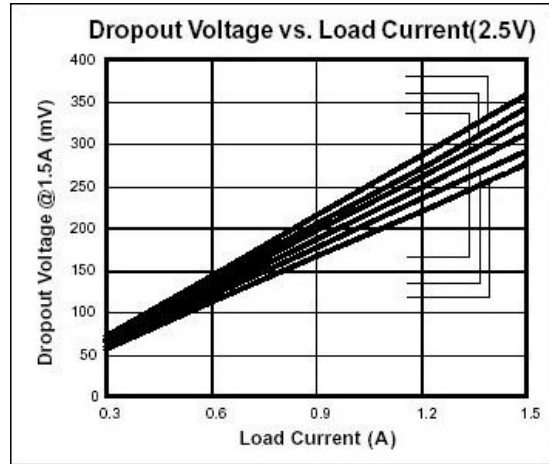
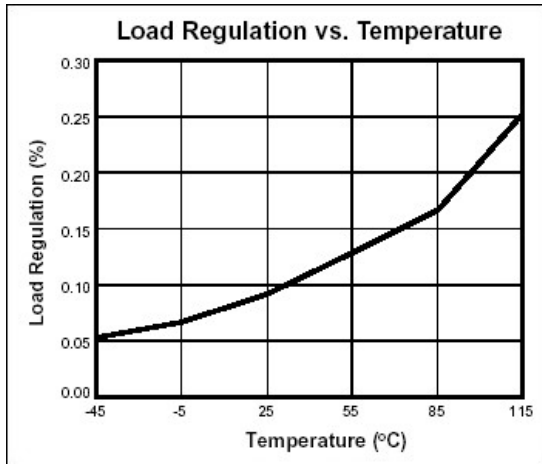

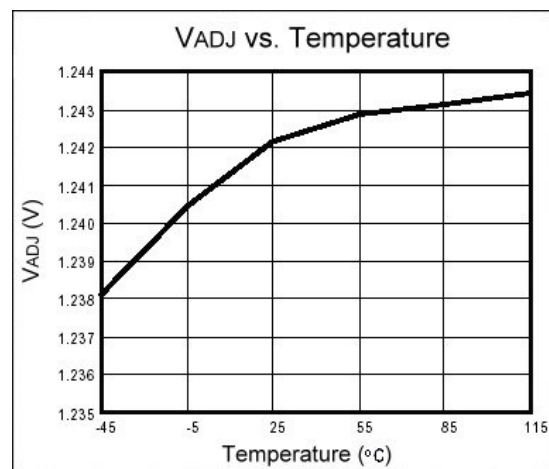
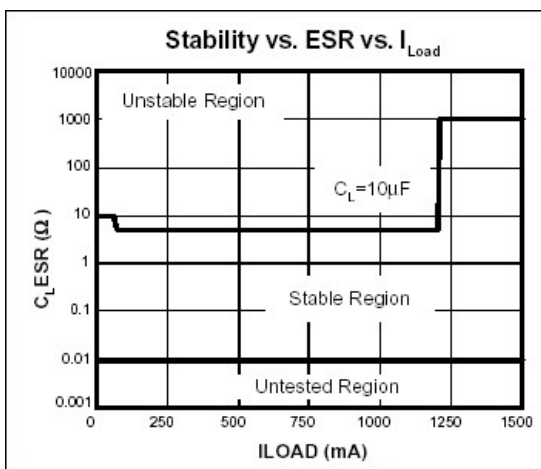
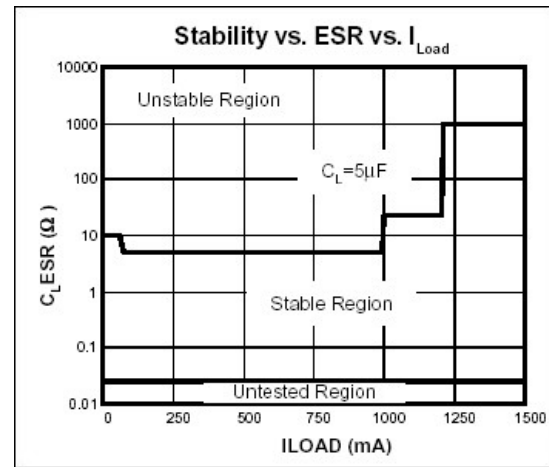
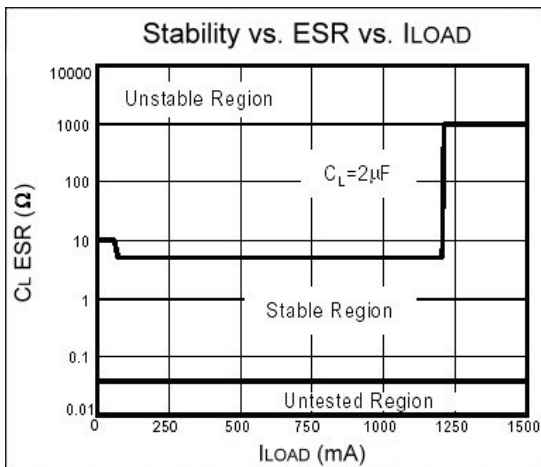
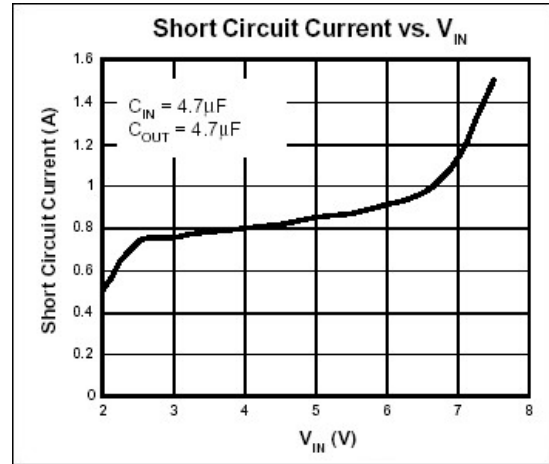
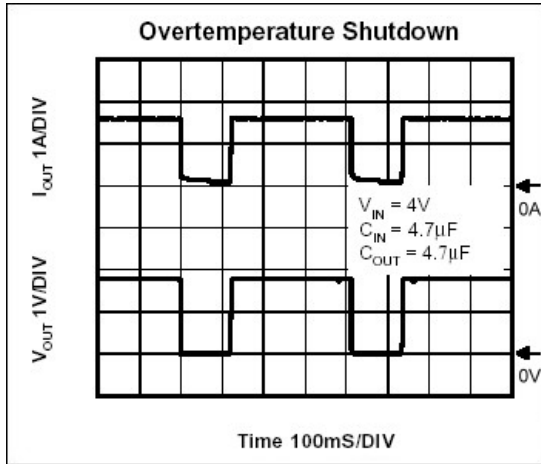



Elektronische Bauelemente

S5J2188

1.5A CMOS

Low Dropout Voltage Regulator

External Resistor Divider Table

R1(kΩ)	1	2	5	10	20	50
V _{OUT}	$R2(k\Omega)=(1.242*R1(k\Omega))/(V_{OUT}-1.242)$					
1.30	21.41	42.83	107.07	214.14	428.28	1070.7
1.35	11.50	23.00	57.50	115.00	230.00	575.00
1.40	7.86	15.72	39.30	78.61	157.22	393.04
1.45	5.97	11.94	29.86	59.71	119.42	298.56
1.50	4.81	9.63	24.07	48.14	96.28	240.70
1.55	4.03	8.06	20.16	40.32	80.65	201.62
1.60	3.47	6.94	17.35	34.69	68.39	173.46
1.65	3.04	6.09	15.22	30.44	60.88	152.21
1.70	2.71	5.42	13.56	27.12	54.24	135.59
1.75	2.44	4.89	12.22	24.45	48.90	122.24
1.80	2.23	4.45	11.13	22.26	44.52	111.29
1.85	2.04	4.09	10.21	20.43	40.86	102.14
1.90	1.89	3.78	9.44	18.88	37.75	94.38
1.95	1.75	3.51	8.77	17.54	35.08	87.71
2.00	1.64	3.28	8.19	16.39	32.77	81.93
2.05	1.54	3.07	7.69	15.37	30.74	76.86
2.10	1.45	2.90	7.24	14.48	28.95	72.38
2.15	1.37	2.74	6.84	13.68	27.36	68.39
2.20	1.30	2.59	6.48	12.96	25.93	64.82
2.25	1.23	2.46	6.16	12.32	24.65	61.61
2.30	1.17	2.35	5.87	11.74	23.48	58.70
2.35	1.12	2.24	5.60	11.21	22.42	56.05
2.40	1.07	2.15	5.36	10.73	21.45	53.63
2.45	1.03	2.06	5.14	10.28	20.56	51.41
2.50	0.99	1.97	4.94	9.87	19.75	49.36
2.55	0.95	1.90	4.75	9.50	18.99	47.48
2.60	0.91	1.83	4.57	9.15	18.29	45.73
2.65	0.88	1.76	4.41	8.82	17.64	44.11
2.70	0.85	1.70	4.26	8.52	17.04	42.59
2.75	0.82	1.65	4.12	8.24	16.47	41.18
2.80	0.80	1.59	3.99	7.97	15.94	39.86
2.85	0.77	1.54	3.86	7.72	15.45	38.62
2.90	0.75	1.50	3.75	7.49	14.98	37.45
2.95	0.73	1.45	3.64	7.27	14.54	36.36
3.00	0.71	1.41	3.53	7.06	14.13	35.32
3.05	0.69	1.37	3.43	6.87	13.74	34.35
3.10	0.67	1.34	3.34	6.68	13.37	33.42
3.15	0.65	1.30	3.25	6.51	13.02	32.55

R1(kΩ)	1	2	5	10	20	50
V _{OUT}	$R2(k\Omega)=(1.242*R1(k\Omega))/(V_{OUT}-1.242)$					
3.20	0.63	1.27	3.17	6.34	12.69	31.72
3.25	0.62	1.24	3.09	6.19	12.37	30.93
3.30	0.60	1.21	3.02	6.03	12.07	30.17
3.35	0.59	1.18	2.95	5.89	11.78	29.46
3.40	0.58	1.15	2.88	5.76	11.51	28.78
3.45	0.56	1.13	2.81	5.63	11.25	28.13
3.50	0.55	1.10	2.75	5.50	11.00	27.50
3.55	0.54	1.08	2.69	5.38	10.76	26.91
3.60	0.53	1.05	2.63	5.27	10.53	26.34
3.65	0.52	1.03	2.58	5.16	10.32	25.79
3.70	0.51	1.01	2.53	5.05	10.11	25.26
3.75	0.50	0.99	2.48	4.95	9.90	24.76
3.80	0.49	0.97	2.43	4.86	9.71	24.28
3.85	0.48	0.95	2.38	4.76	9.52	23.81
3.90	0.47	0.93	2.34	4.67	9.35	23.36
3.95	0.46	0.92	2.29	4.59	9.17	22.93
4.00	0.45	0.90	2.25	4.50	9.01	22.52
4.05	0.44	0.88	2.21	4.42	8.85	22.12
4.10	0.43	0.87	2.17	4.35	8.69	21.73
4.15	0.43	0.85	2.14	4.27	8.54	21.35
4.20	0.42	0.84	2.10	4.20	8.40	20.99
4.25	0.41	0.83	2.06	4.13	8.26	20.64
4.30	0.41	0.81	2.03	4.06	8.12	20.31
4.35	0.40	0.80	2.00	4.00	7.99	19.98
4.40	0.39	0.79	1.97	3.93	7.87	19.66
4.45	0.39	0.77	1.94	3.87	7.74	19.36
4.50	0.38	0.76	1.91	3.81	7.62	19.06
4.55	0.38	0.75	1.88	3.75	7.51	18.77
4.60	0.37	0.74	1.85	3.70	7.40	18.49
4.65	0.36	0.73	1.82	3.64	7.29	18.22
4.70	0.36	0.72	1.80	3.59	7.18	17.96
4.75	0.35	0.71	1.77	3.54	7.08	17.70
4.80	0.35	0.70	1.75	3.49	6.98	17.45
4.85	0.34	0.69	1.72	3.44	6.88	17.21
4.90	0.34	0.68	1.70	3.40	6.79	16.98
4.95	0.33	0.67	1.67	3.35	6.70	16.75
5.00	0.33	0.66	1.65	3.30	6.61	16.52

Note: Small load (greater than 2mA) is necessary as R1 or R2 is larger than 50kΩ. Otherwise, output voltage probably can not be pulled down to 0V on disable mode.