

# Three phase full Bridge

with Trench MOSFETs  
in DCB isolated high current package

$V_{DSS} = 100\text{ V}$   
 $I_{D25} = 90\text{ A}$   
 $R_{DSon\ typ.} = 7.5\text{ m}\Omega$

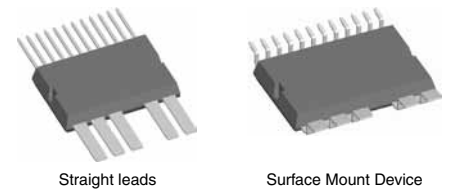
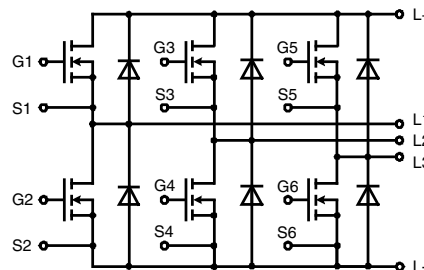

MOSFETs		Maximum Ratings	
Symbol	Conditions		
$V_{DSS}$	$T_J = 25^\circ\text{C to } 150^\circ\text{C}$	100	V
$V_{GS}$		$\pm 20$	V
$I_{D25}$	$T_C = 25^\circ\text{C}$	90	A
$I_{D90}$	$T_C = 90^\circ\text{C}$	68	A
$I_{F25}$	$T_C = 25^\circ\text{C (diode)}$	90	A
$I_{F90}$	$T_C = 90^\circ\text{C (diode)}$	68	A

### Applications

- AC drives
- in automobiles
    - electric power steering
    - starter generator
  - in industrial vehicles
    - propulsion drives
    - fork lift drives
  - in battery supplied equipment

Symbol	Conditions	Characteristic Values				
		min.	typ.	max.		
$R_{DSon}^{1)}$	on chip level at $V_{GS} = 10\text{ V}; I_D = 80\text{ A}$	$T_J = 25^\circ\text{C}$ $T_J = 125^\circ\text{C}$		7.5 14	$m\Omega$ $m\Omega$	
$V_{GS(th)}$	$V_{DS} = 20\text{ V}; I_D = 250\ \mu\text{A}$	2.5		4.5	V	
$I_{DSS}$	$V_{DS} = V_{DSS}; V_{GS} = 0\text{ V}$		0.1	1	$\mu\text{A}$ mA	
$I_{GSS}$	$V_{GS} = \pm 20\text{ V}; V_{DS} = 0\text{ V}$			0.2	$\mu\text{A}$	
$Q_g$ $Q_{gs}$ $Q_{gd}$	$V_{GS} = 10\text{ V}; V_{DS} = 65\text{ V}; I_D = 90\text{ A}$		90 30 30		nC nC nC	
$t_{d(on)}$ $t_r$ $t_{d(off)}$ $t_f$		inductive load $V_{GS} = 10\text{ V}; V_{DS} = 48\text{ V}$ $I_D = 70\text{ A}; R_G = 33\ \Omega;$ $T_J = 125^\circ\text{C}$		130 95 290 55		ns ns ns ns
$E_{on}$ $E_{off}$ $E_{recoff}$				0.4 0.4 0.007		mJ mJ mJ
$R_{thJC}$ $R_{thJH}$	with heat transfer paste (IXYS test setup)			1.3	1.0 1.6	K/W K/W

### Features

- MOSFETs in trench technology:
  - low  $R_{DSon}$
  - optimized intrinsic reverse diode
- package:
  - high level of integration
  - high current capability 300 A max.
  - aux. terminals for MOSFET control
  - terminals for soldering or welding connections
  - isolated DCB ceramic base plate with optimized heat transfer
- Space and weight savings

### Package options

- 2 lead frames available
  - straight leads (SL)
  - SMD lead version (SMD)

<sup>1)</sup>  $V_{DS} = I_D \cdot (R_{DS(on)} + 2R_{Pin\ to\ chip})$

**Recommended replacements: MTI 85W100GC**

**Source-Drain Diode**

Symbol	Conditions	Characteristic Values			
		min.	typ.	max.	
( $T_J = 25^\circ\text{C}$ , unless otherwise specified)					
$V_{SD}$	(diode) $I_F = 70\text{ A}$ ; $V_{GS} = 0\text{ V}$		0.9	1.2	V
$t_{rr}$	} $I_F = 70\text{ A}$ ; $-di_F/dt = 800\text{ A}/\mu\text{s}$ ; $V_R = 48\text{ V}$		55		ns
$Q_{RM}$			0.95		$\mu\text{C}$
$I_{RM}$			33		A

**Component**

Symbol	Conditions	Maximum Ratings	
$I_{RMS}$	per pin in main current paths (P+, N-, L1, L2, L3) may be additionally limited by external connections	300	A
$T_J$		-55...+175	$^\circ\text{C}$
$T_{stg}$		-55...+125	$^\circ\text{C}$
$V_{ISOL}$	$I_{ISOL} \leq 1\text{ mA}$ , 50/60 Hz, $f = 1\text{ minute}$	1000	V~
$F_C$	mounting force with clip	50 - 250	N

Symbol	Conditions	Characteristic Values		
		min.	typ.	max.
$R_{pin\ to\ chip}^{1)}$			0.6	m $\Omega$
$C_P$	coupling capacity between shorted pins and mounting tab in the case		160	pF
<b>Weight</b>			25	g

<sup>1)</sup>  $V_{DS} = I_D \cdot (R_{DS(on)} + 2R_{Pin\ to\ Chip})$

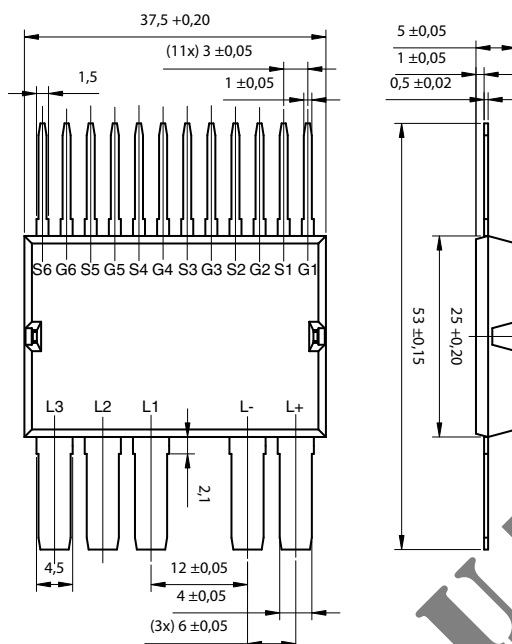
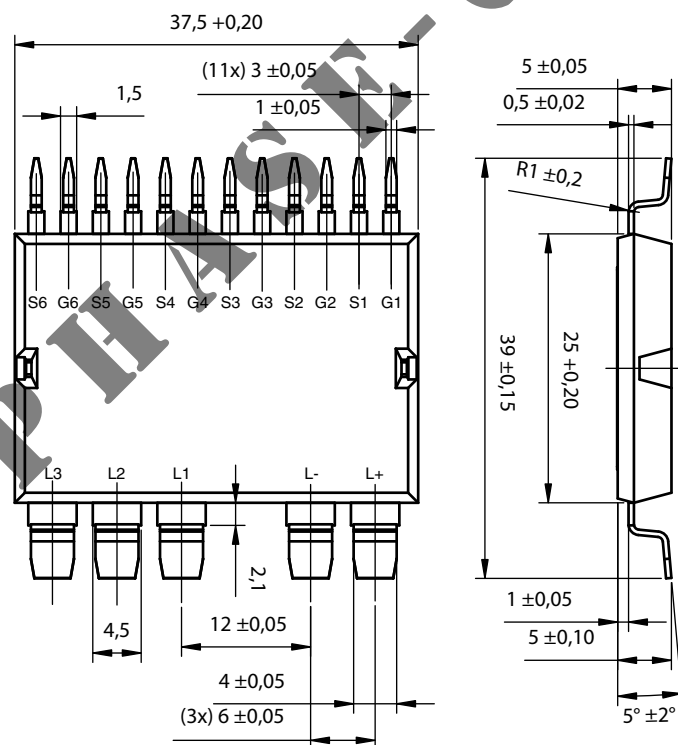
**Straight Leads GWM 100-01X1-SL**

**Surface Mount Device GWM 100-01X1-SMD**

Leads	Ordering	Part Name & Packing Unit Marking	Part Marking	Delivering Mode	Base Qty.	Ordering Code
Straight	Standard	GWM 100-01X1 - SL	GWM 100-01X1	Blister	28	505 535
SMD	Standard	GWM 100-01X1 - SMD	GWM 100-01X1	Blister	28	505 542

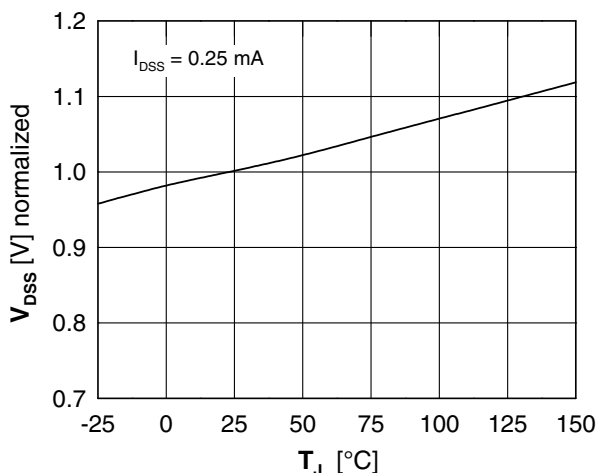

Fig. 1 Drain source breakdown voltage  $V_{DSS}$  vs. junction temperature  $T_J$

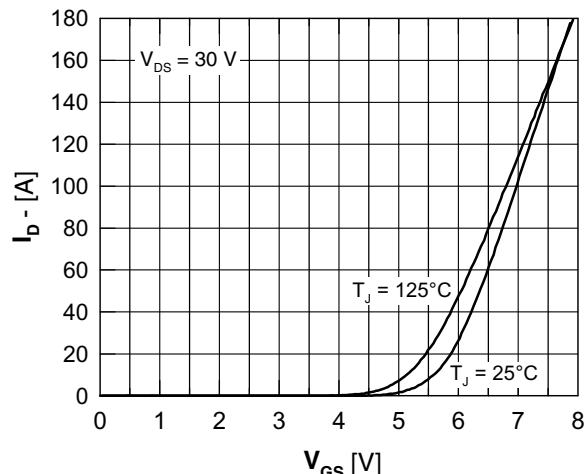

Fig. 2 Typical transfer characteristic

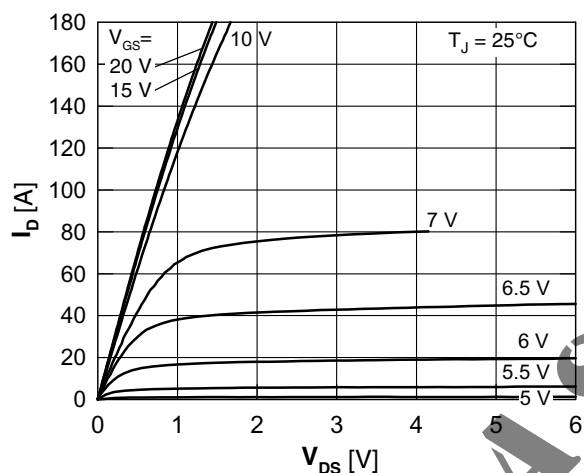

Fig. 3 Typical output characteristic

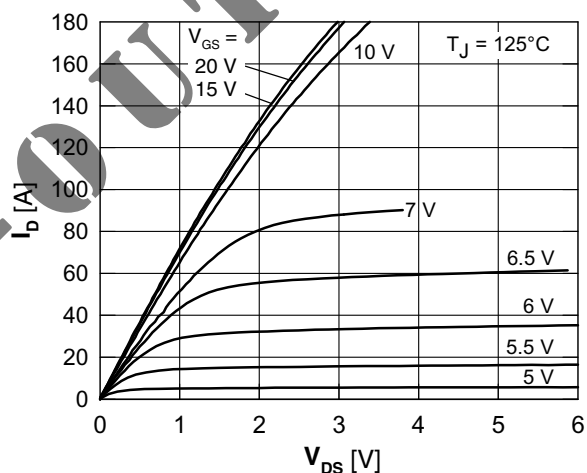

Fig. 4 Typical output characteristic

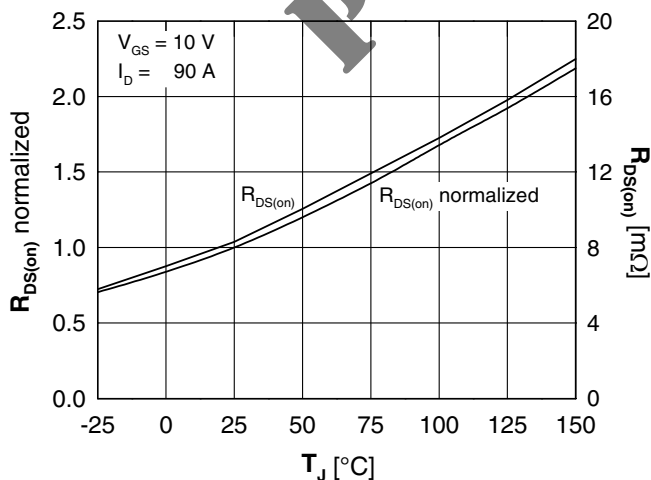

Fig. 5 Drain source on-state resistance  $R_{DS(on)}$  versus junction temperature  $T_J$

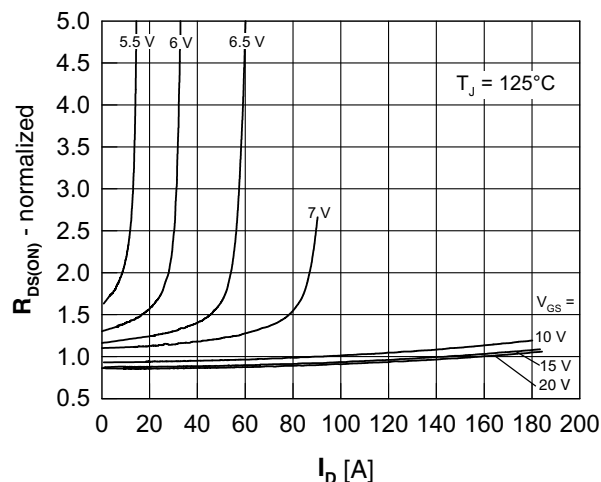

Fig. 6 Drain source on-state resistance  $R_{DS(on)}$  versus  $I_D$

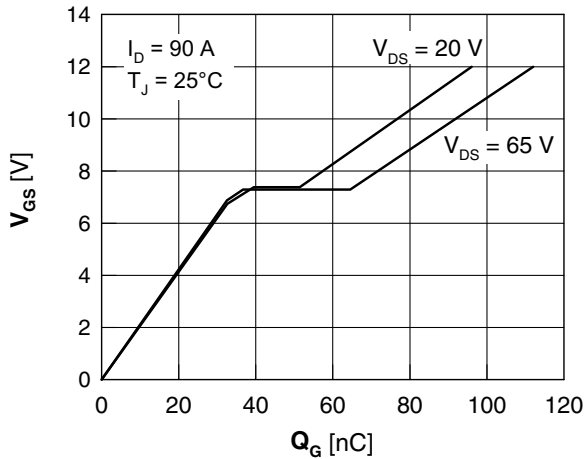

Fig. 7 Gate charge characteristic

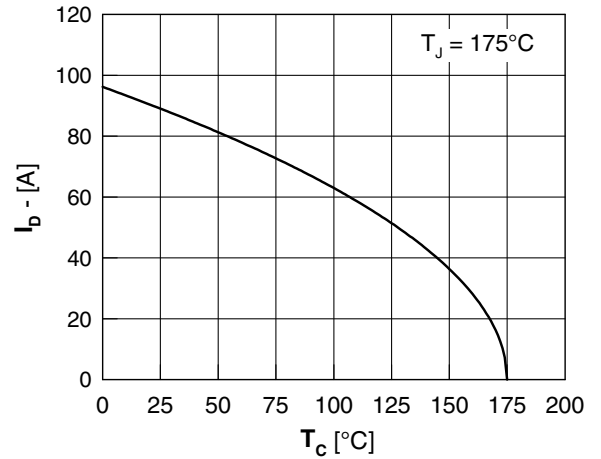

Fig. 8 Drain current  $I_D$  vs. case temperature  $T_c$

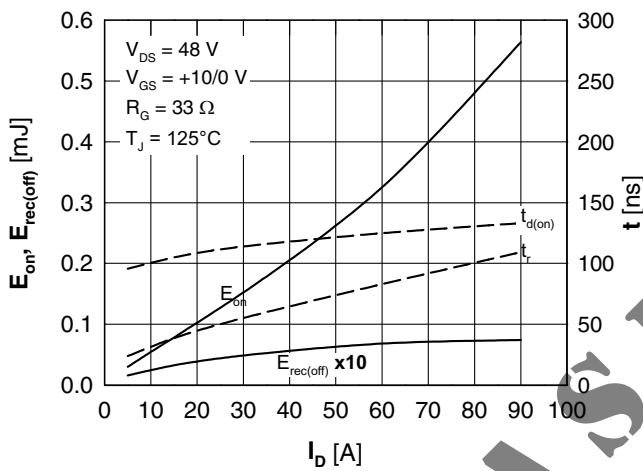

Fig. 9 Typ. turn-on energy & switching times vs. collector current, inductive switching

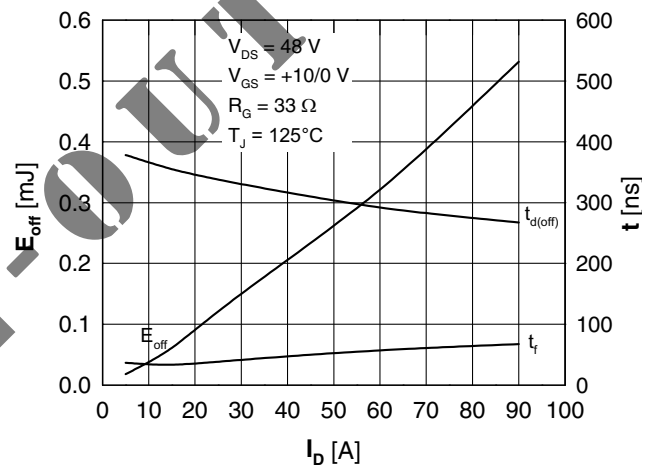

Fig. 10 Typ. turn-off energy & switching times vs. collector current, inductive switching

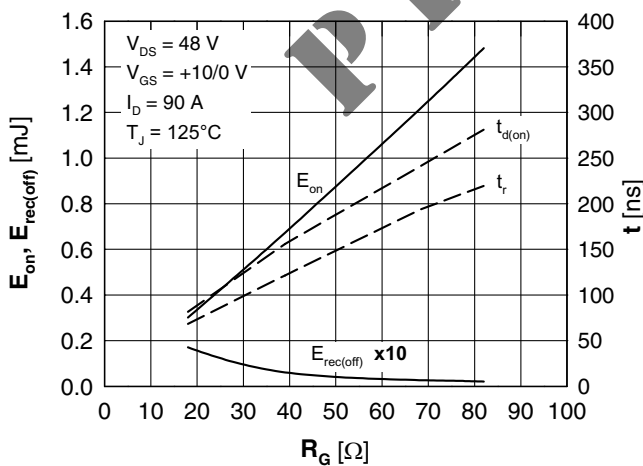

Fig. 11 Typ. turn-on energy & switching times vs. gate resistor, inductive switching

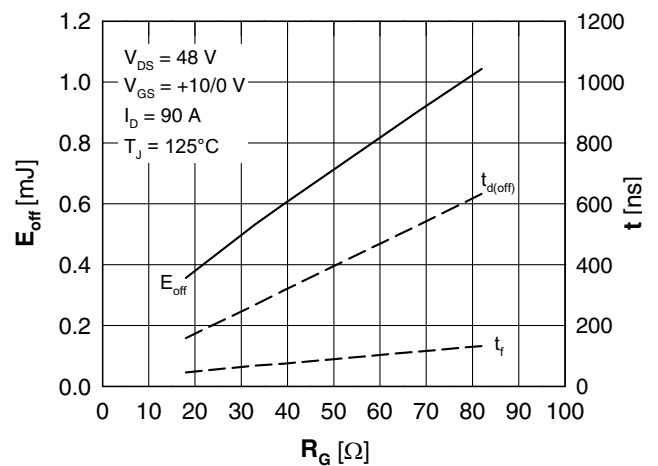

Fig. 12 Typ. turn-off energy & switching times vs. gate resistor, inductive switching

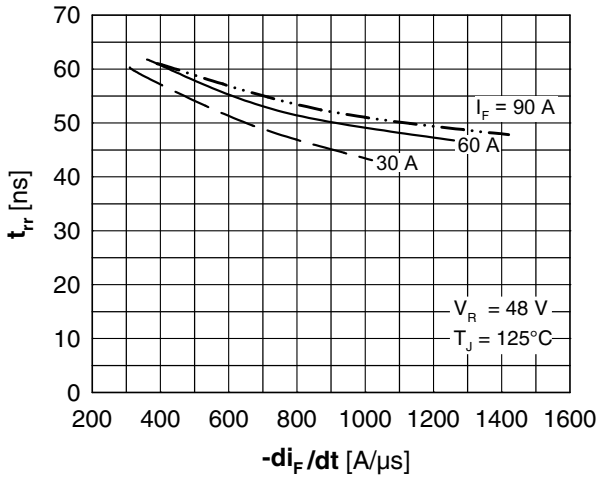

Fig. 13 Reverse recovery time  $t_{rr}$  of the body diode vs.  $di/dt$

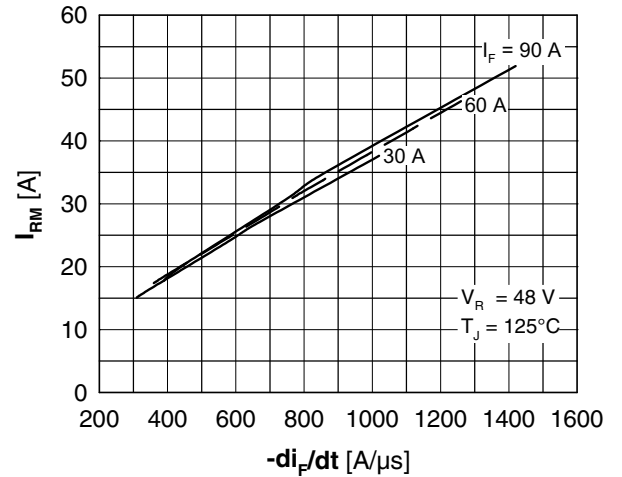

Fig. 14 Reverse recovery current  $I_{RM}$  of the body diode vs.  $di/dt$

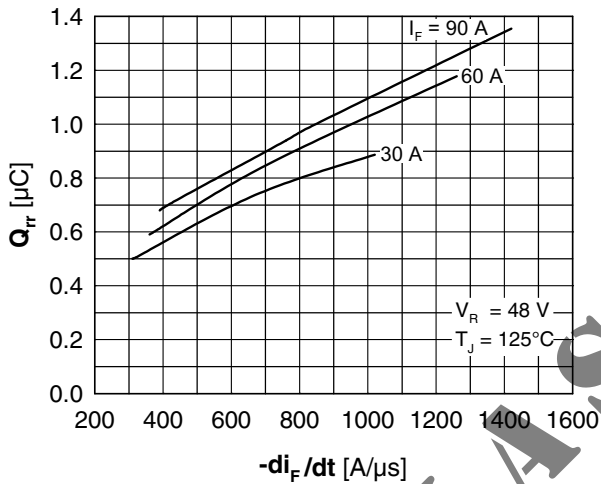

Fig. 15 Reverse recovery charge  $Q_{rr}$  of the body diode vs.  $di/dt$

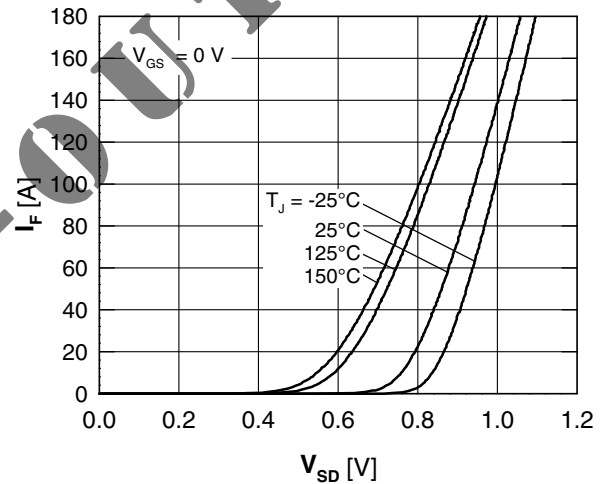

Fig. 16 Source drain diode current  $I_F$  vs. source drain voltage  $V_{SD}$  (body diode)

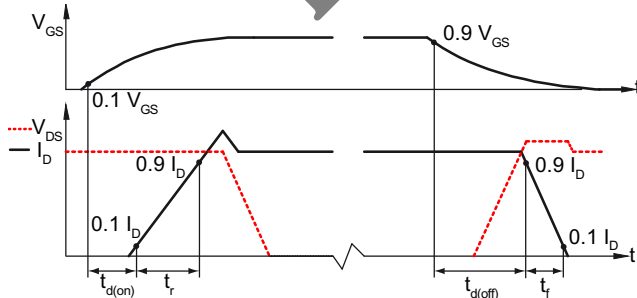

Fig. 17 Definition of switching times

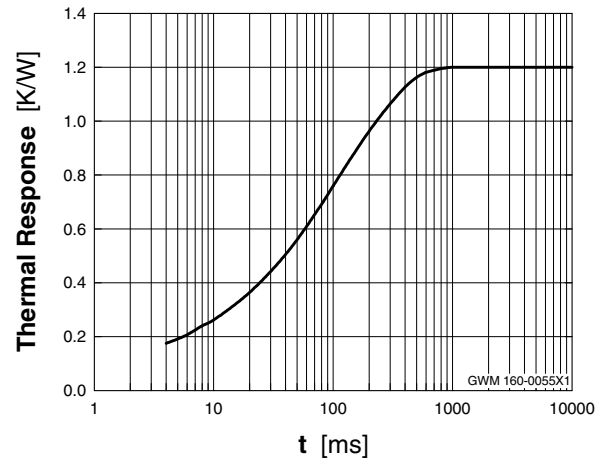

Fig. 18 Typ. thermal impedance junction to heatsink  $Z_{thJH}$  with heat transfer paste