

CDBC320-G Thru. CDBC3100-G

Reverse Voltage: 20 to 100 Volts

Forward Current: 3.0 Amp

RoHS Device

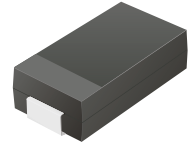

Features

- Ideal for surface mount applications.
- Easy pick and place.
- Plastic package has Underwriters Lab. flammability classification 94V-0.
- Built-in strain relief.
- Low forward voltage drop.

Mechanical data

- Case: JEDEC DO-214AB, molded plastic.
- Terminals: solderable per MIL-STD-750, method 2026.
- Polarity: Color band denotes cathode end.
- Approx. weight: 0.21 grams

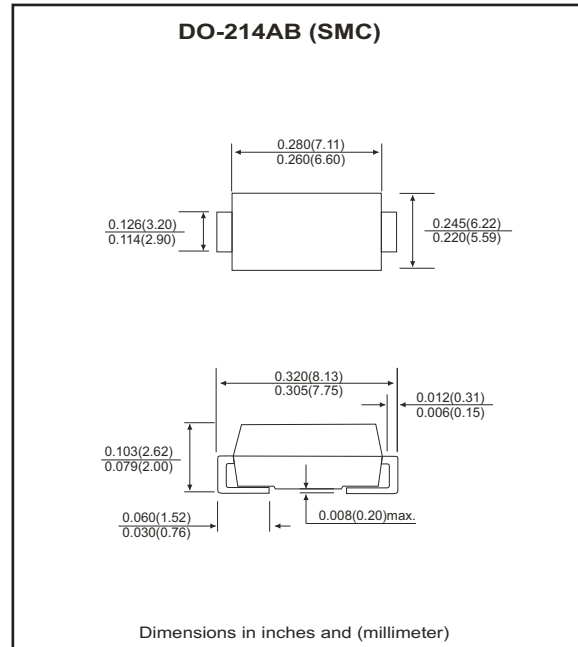

Maximum Ratings and Electrical Characteristics

Parameter	Symbol	CDBC 320-G	CDBC 340-G	CDBC 360-G	CDBC 380-G	CDBC 3100-G	Units
Max. repetitive peak reverse voltage	V_{RRM}	20	40	60	80	100	V
Max. DC blocking voltage	V_{DC}	20	40	60	80	100	V
Max. RMS voltage	V_{RMS}	14	28	42	56	70	V
Peak surge forward current, 8.3ms single half sine-wave superimposed on rate load (JEDEC method)	I_{FSM}	80					A
Max. average forward current	I_o	3.0					A
Max. instantaneous forward voltage at 3.0A	V_F	0.50		0.70	0.85		V
Max. DC reverse current at $T_A=25\text{ }^{\circ}\text{C}$ rated DC blocking voltage $T_A=100\text{ }^{\circ}\text{C}$	I_R	0.5					mA
		20		10			
Max. thermal resistance (Note 1)	$R_{\theta JA}$	50					$^{\circ}\text{C/W}$
	$R_{\theta JL}$	10					
Max. operating junction temperature	T_J	125					$^{\circ}\text{C}$
Storage temperature	T_{STG}	-65 to +150					$^{\circ}\text{C}$

Notes: 1. Thermal resistance from junction to ambient and junction to lead mounted on P.C.B. with 0.2×0.2 inch copper pad area.

RATING AND CHARACTERISTIC CURVES (CDBC320-G thru CDBC3100-G)

Fig.1 Reverse Characteristics

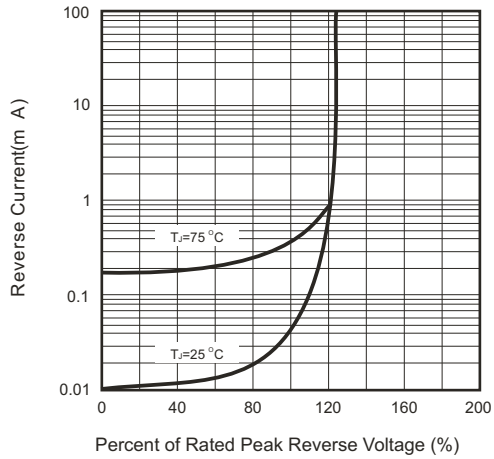

Fig.2 Forward Characteristics

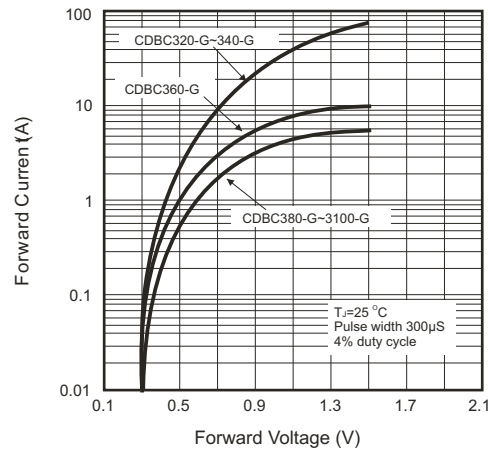

Fig.3 Junction Capacitance

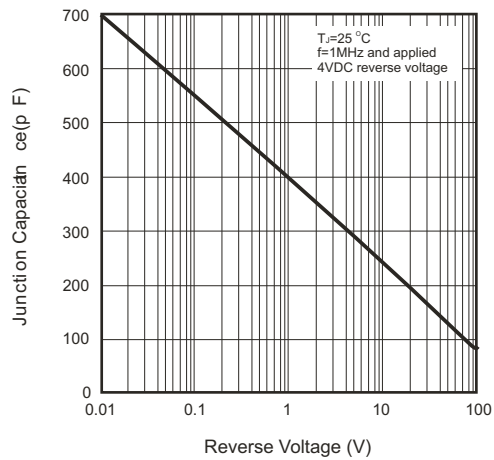

Fig.4 Current Derating Curve

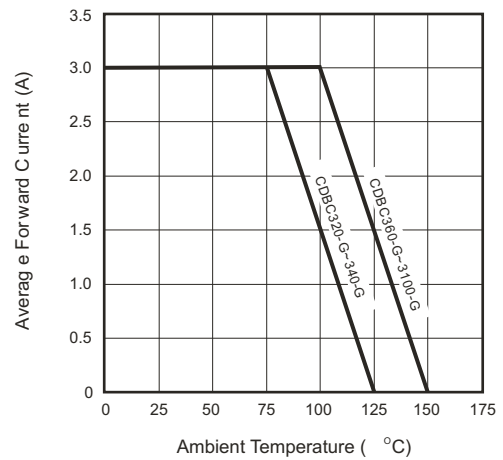
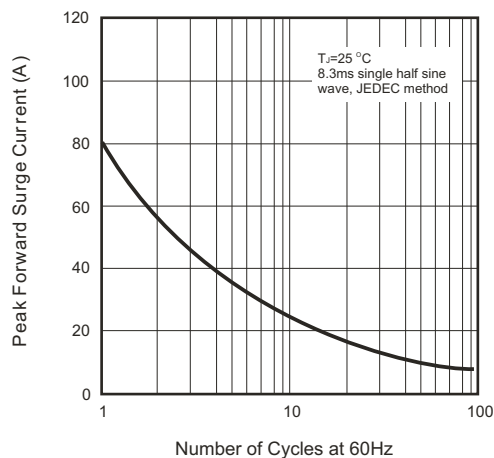
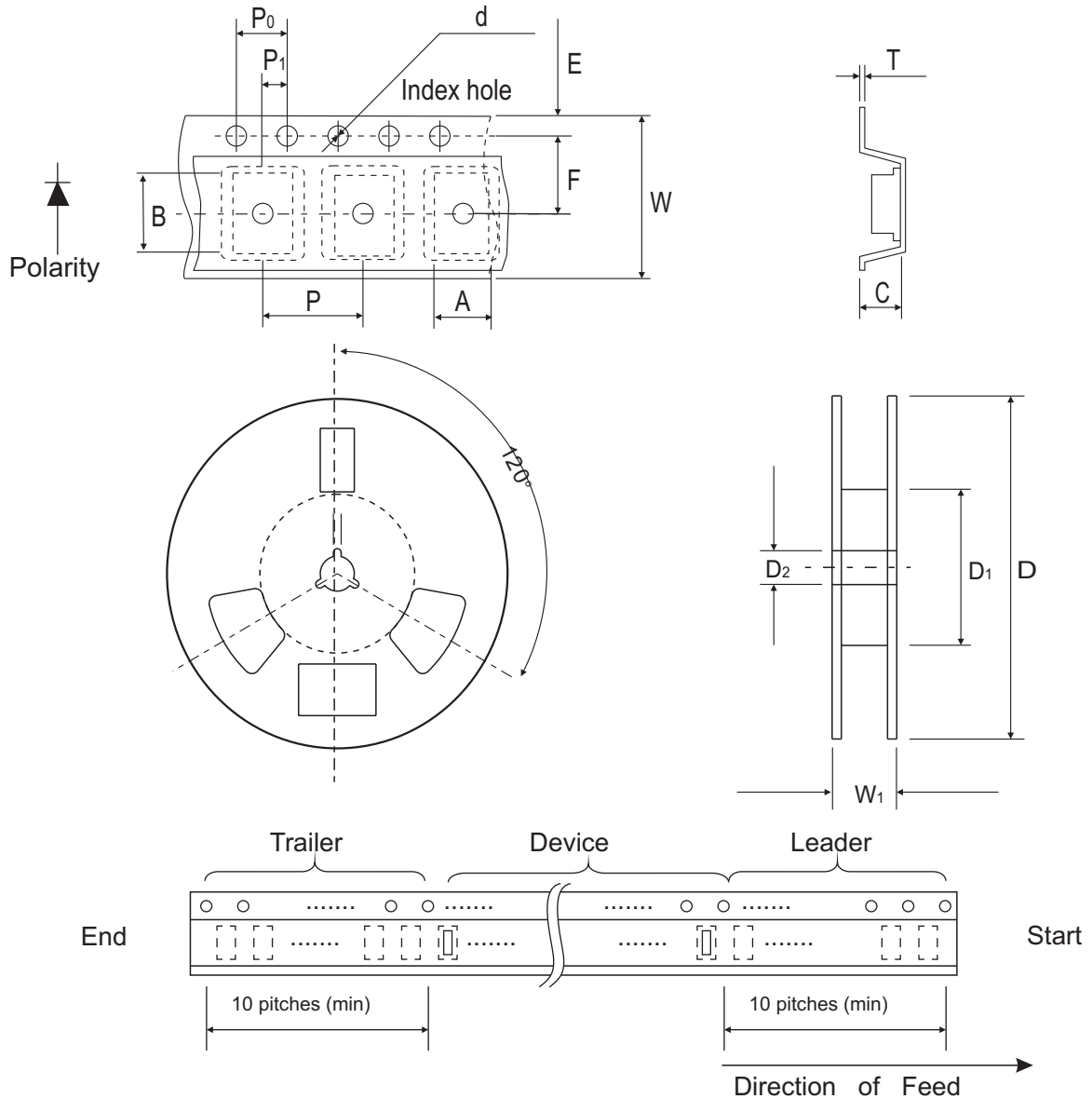

Fig.5 Non-repetitive Forward Surge Current



Reel Taping Specification



SMC (DO-214AB)	SYMBOL	A	B	C	d	D	D ₁	D ₂
	(mm)	6.30 (max)	8.60 (max)	2.90 (max)	1.50 ± 0.10	330	50.0 MIN.	13.5 ± 1.00
	(inch)	0.248 (max)	0.339 (max)	0.114 (max)	0.059 ± 0.004	12.99	1.969 MIN.	0.531 ± 0.039

SMC (DO-214AB)	SYMBOL	E	F	P	P ₀	P ₁	W	W ₁
	(mm)	1.75 ± 0.10	7.50 ± 0.05	8.00 ± 0.10	4.00 ± 0.10	2.00 ± 0.05	16.0 ± 0.20	22.4 (max)
	(inch)	0.689 ± 0.004	0.295 ± 0.002	0.315 ± 0.004	0.157 ± 0.004	0.079 ± 0.002	0.630 ± 0.008	0.882 (max)

Marking Code

Part Number	Marking Code
CDBC320-G	320
CDBC340-G	340
CDBC360-G	360
CDBC380-G	380
CDBC3100-G	3100



xxxx = Product type marking code

Suggested PAD Layout

SIZE	DO-214AB(SMC)	
	(mm)	(inch)
A	6.20	0.244
B	1.60	0.063
C	4.80	0.189
D	7.80	0.307
E	4.60	0.181

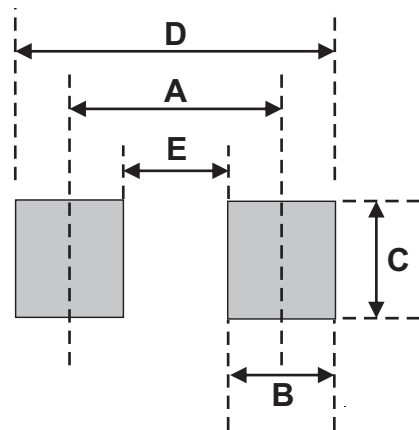

Standard Package

Case Type	Qty per Reel	Reel Size
	(Pcs)	(inch)
DO-214AB (SMC)	3000	13