

# PQ05SZ5/PQ05SZ1 Series

Low Power-Loss Voltage Regulators (Built-in Reverse Voltage Protection Function)

## ■ Features

- Low power-loss (Dropout voltage : MAX. 0.5V)
- Surface mount type package (Equivalent to SC-63)
- Built-in a function to prevent reverse voltage between input and output  
The diode to prevent reverse voltage between input and output is not necessary. (When  $V_{O-I} \leq 13V$ )

## ■ Applications

- Portable equipment
- Notebook PC

## ■ Model Line-ups

		5V output	9V output	12V output
0.5A output	Output voltage precision: $\pm 5\%$	PQ05SZ5	PQ09SZ5	PQ12SZ5
	Output voltage precision: $\pm 2.5\%$	PQ05SZ51	PQ09SZ51	PQ12SZ51
1A output	Output voltage precision: $\pm 5\%$	PQ05SZ1	PQ09SZ1	PQ12SZ1
	Output voltage precision: $\pm 2.5\%$	PQ05SZ11	PQ09SZ11	PQ12SZ11

## ■ Outline Dimensions

(Unit : mm)

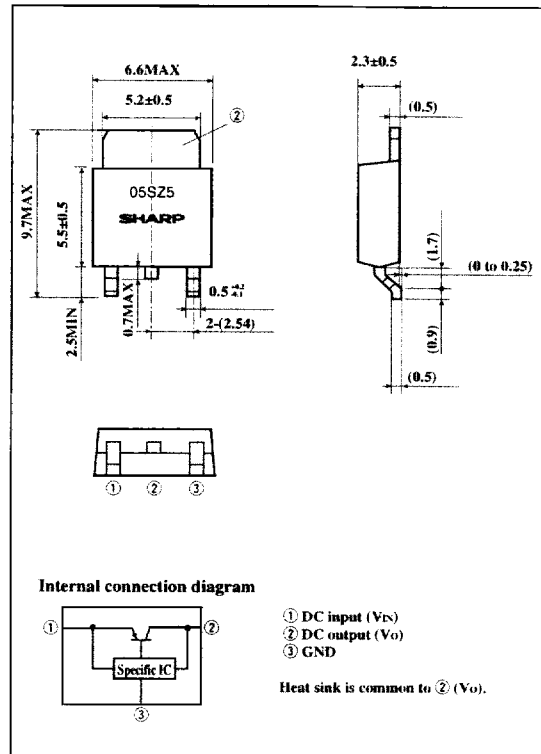

## ■ Absolute Maximum Ratings

( $T_a = 25^\circ C$ ,  $xx=05,09,12$ )

Parameter	Symbol	Conditions	Rating		Unit
			PQxxSZ5/51	PQxxSZ1/11	
Input voltage	$V_{IN}$	*1	24		V
Input-output reverse voltage	$V_{O-I}$	$V_{IN}=0V$	13		V
Output current	$I_O$		0.5	1.0	A
Power dissipation	$P_D$	Refer to Fig. 4*2	8		W
Junction temperature	$T_J$	*	150		$^\circ C$
Operating temperature	$T_{opr}$		-20 to +80		$^\circ C$
Storage temperature	$T_{stg}$		-40 to +150		$^\circ C$
Soldering temperature	$T_{sol}$	For 10s	260		$^\circ C$

\*1 All are open except GND and applicable terminals.

\*2 With infinite heat sink.

\* Over heat protection may operate at  $125^\circ C \leq T_J < 150^\circ C$

SHARP

\* In the absence of confirmation by device specification sheets, SHARP takes no responsibility for any defects that may occur in equipment using any SHARP devices shown in catalogs, data books, etc. Contact SHARP in order to obtain the latest version of the device specification sheets before using any SHARP's device. \*

■ Electrical Characteristics

(T<sub>j</sub>=25°C, xx=05,09,12)

Parameter	Symbol	Conditions	MIN.	TYP.	MAX.	Unit
Output voltage	V <sub>O</sub>	V <sub>IN</sub> =7V	4.75	5.0	5.25	V
		V <sub>IN</sub> =11V	8.55	9.0	9.45	
		V <sub>IN</sub> =14V	11.4	12.0	12.6	
		V <sub>IN</sub> =7V	4.88	5.0	5.12	
		V <sub>IN</sub> =11V	8.78	9.0	9.22	
		V <sub>IN</sub> =14V	11.7	12.0	12.3	
Load regulation	R <sub>regL</sub>	*4	-	0.2	2.0	%
Line regulation	R <sub>regI</sub>	I <sub>O</sub> =5mA, *5	-	0.1	2.5	%
Temperature coefficient of output voltage	T <sub>c</sub> V <sub>O</sub>	I <sub>O</sub> =5mA, T <sub>j</sub> =0 to 125°C, *6	-	±0.01	-	%/°C
Ripple rejection	RR	Refer to Fig. 2	45	60	-	dB
Dropout voltage	V <sub>i-o</sub>	I <sub>O</sub> =0.5A	-	0.2	0.5	V
		I <sub>O</sub> =0.3A	-	0.2	0.5	
Quiescent current	I <sub>q</sub>	I <sub>O</sub> =0A, *6	-	4.0	10.0	mA

\*3 PQxxSZ1/11 Series: I<sub>O</sub>=0.5A  
PQxxSZ5/51 Series: I<sub>O</sub>=0.3A

\*4 PQ05SZ1/11: V<sub>IN</sub>=7V, I<sub>O</sub>=5mA to 1.0A PQ05SZ5/51: V<sub>IN</sub>=7V, I<sub>O</sub>=5mA to 0.5A  
PQ09SZ1/11: V<sub>IN</sub>=11V, I<sub>O</sub>=5mA to 1.0A PQ09SZ5/51: V<sub>IN</sub>=11V, I<sub>O</sub>=5mA to 0.5A  
PQ12SZ1/11: V<sub>IN</sub>=14V, I<sub>O</sub>=5mA to 1.0A PQ12SZ5/51: V<sub>IN</sub>=14V, I<sub>O</sub>=5mA to 0.5A

\*5 PQ05SZ1/11/5/51: V<sub>IN</sub>=6 to 16V  
PQ09SZ1/11/5/51: V<sub>IN</sub>=10 to 20V  
PQ12SZ1/11/5/51: V<sub>IN</sub>=13 to 23V

\*6 PQ05SZ1/11/5/51: V<sub>IN</sub>=7V  
PQ09SZ1/11/5/51: V<sub>IN</sub>=11V  
PQ12SZ1/11/5/51: V<sub>IN</sub>=14V

\*7 Input voltage shall be the value when output voltage is 95% in comparison with the initial value.

Fig.1 Test Circuit

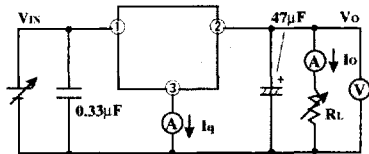
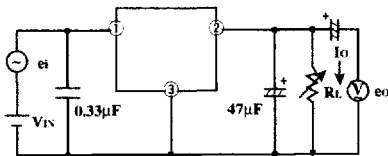

Fig.2 Test Circuit of Ripple Rejection



f=120Hz (sine wave)  
e<sub>i</sub>=0.5V<sub>rms</sub>  
V<sub>IN</sub>= 7V (PQ05SZ1/11/5/51)  
V<sub>IN</sub>=11V (PQ09SZ1/11/5/51)  
V<sub>IN</sub>=14V (PQ12SZ1/11/5/51)  
I<sub>O</sub>=0.3A  
RR=20 log (e<sub>i</sub>/e<sub>o</sub>)

Fig.3 Overcurrent Protection Characteristics(Typical Value)

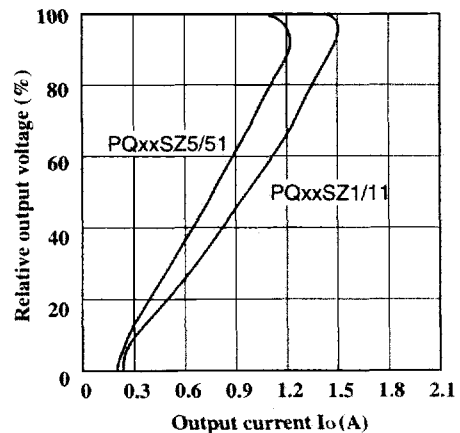
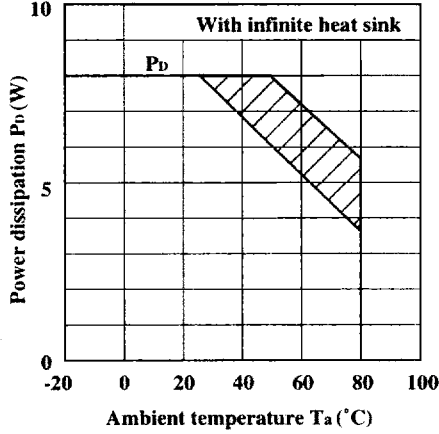

Fig.4 Power Dissipation vs. Ambient Temperature



Note) Oblique line portion: Overheat protection may operate in this area.

Fig.6 Output Voltage Deviation vs. Junction Temperature (PQ09SZ1/PQ09SZ11/PQ09SZ5/PQ09SZ51)

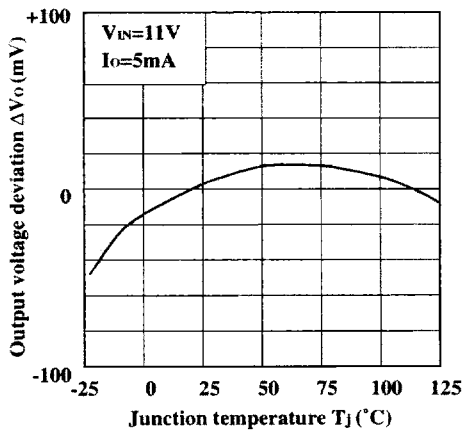

Fig.8 Output Voltage vs. Input Voltage (PQ05SZ1/PQ05SZ11)

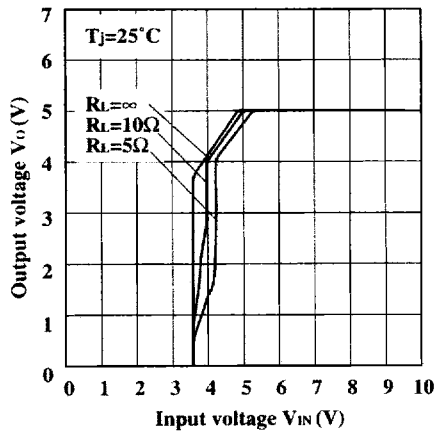

Fig.5 Output Voltage Deviation vs. Junction Temperature (PQ05SZ1/PQ05SZ11/PQ05SZ5/PQ05SZ51)

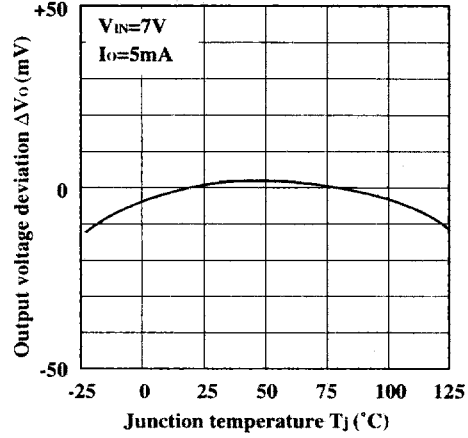

Fig.7 Output Voltage Deviation vs. Junction Temperature (PQ12SZ1/PQ12SZ11/PQ12SZ5/PQ12SZ51)

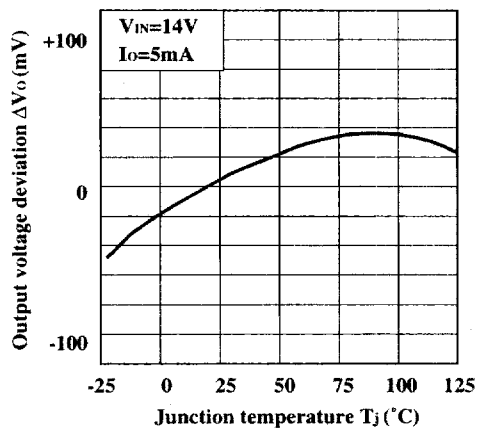

Fig.9 Output Voltage vs. Input Voltage (PQ05SZ5/PQ05SZ51)

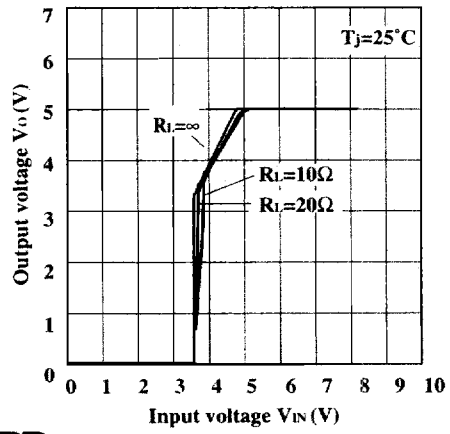

Fig.10 Output Voltage vs. Input Voltage (PQ09SZ1/PQ09SZ11)

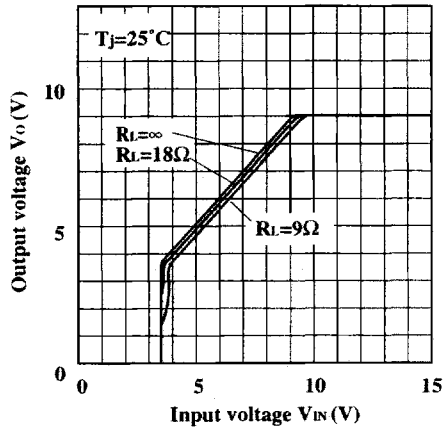

Fig.11 Output Voltage vs. Input Voltage (PQ09SZ5/PQ09SZ51)

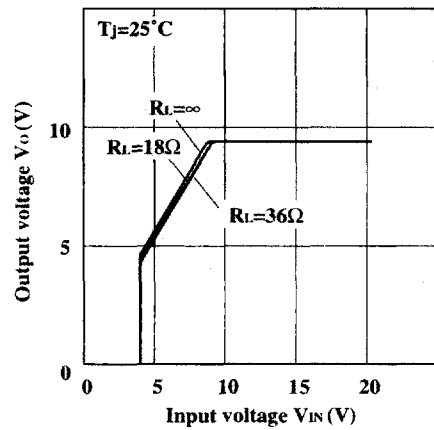

Fig.12 Output Voltage vs. Input Voltage (PQ12SZ1/PQ12SZ11)

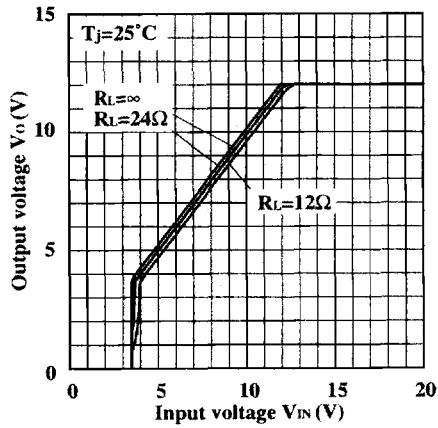

Fig.13 Output Voltage vs. Input Voltage (PQ12SZ5/PQ12SZ51)

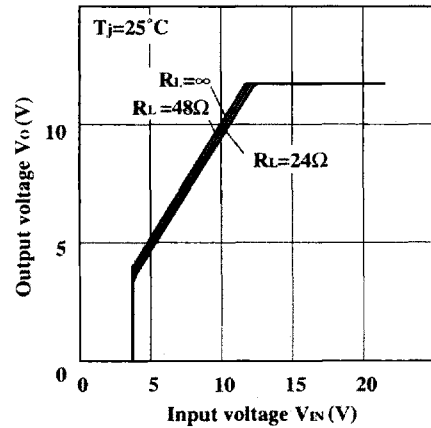

Fig.14-a Dropout Voltage vs. Junction Temperature (PQ05SZ5/51 Series)

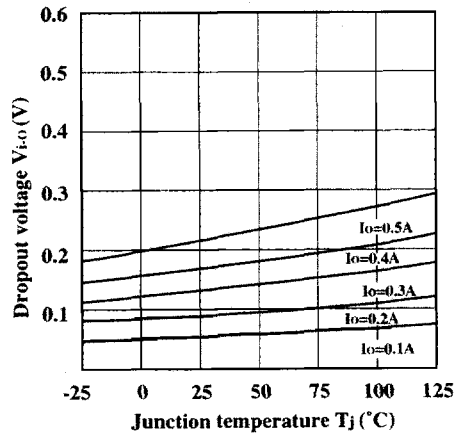

Fig.14-b Dropout Voltage vs. Junction Temperature (PQ05SZ1/11 Series)

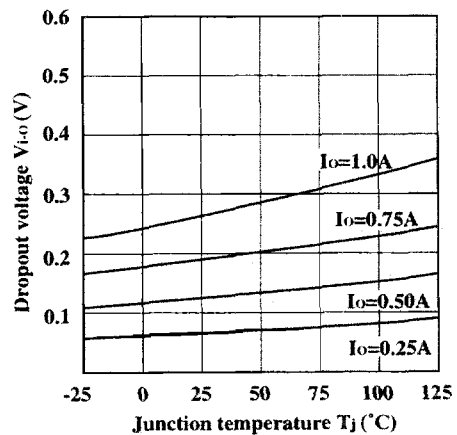

Fig.15 Circuit Operating Current vs. Input Voltage (PQ05SZ1/PQ05SZ11)

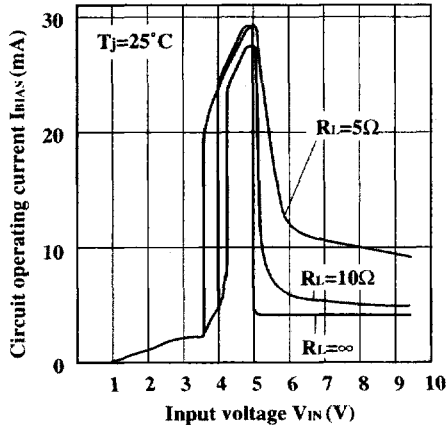

Fig.16 Circuit Operating Current vs. Input Voltage (PQ05SZ5/PQ05SZ51)

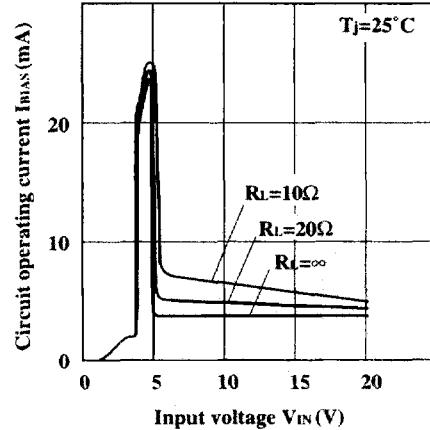

Fig.17 Circuit Operating Current vs. Input Voltage (PQ09SZ1/PQ09SZ11)

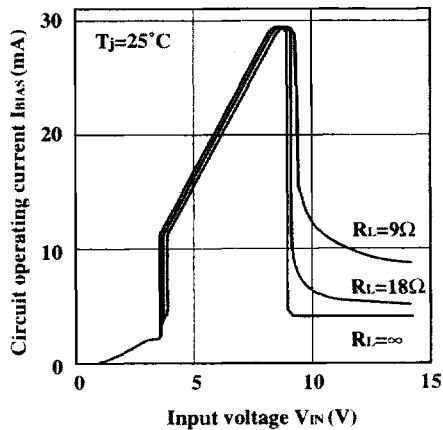

Fig.18 Circuit Operating Current vs. Input Voltage (PQ09SZ5/PQ09SZ51)

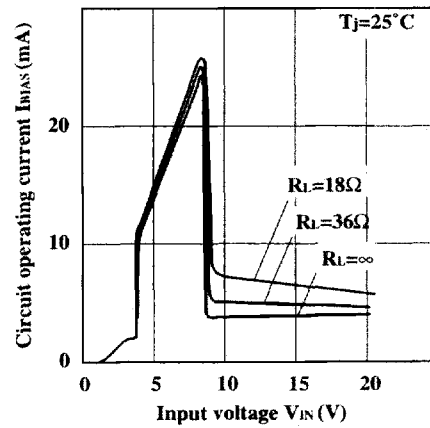

Fig.19 Circuit Operating Current vs. Input Voltage (PQ12SZ1/PQ12SZ11)

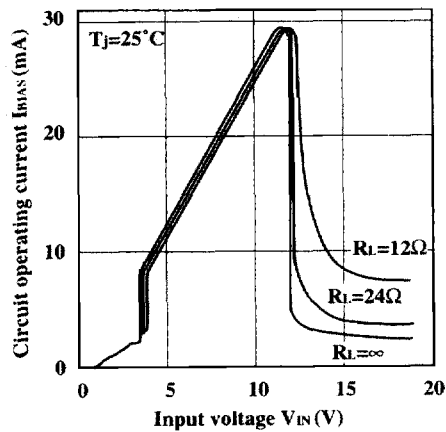

Fig.20 Circuit Operating Current vs. Input Voltage (PQ12SZ5/PQ12SZ51)

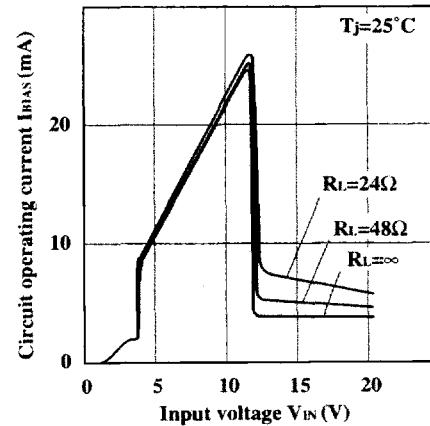

Fig.21 Quiescent Current vs. Junction Temperature

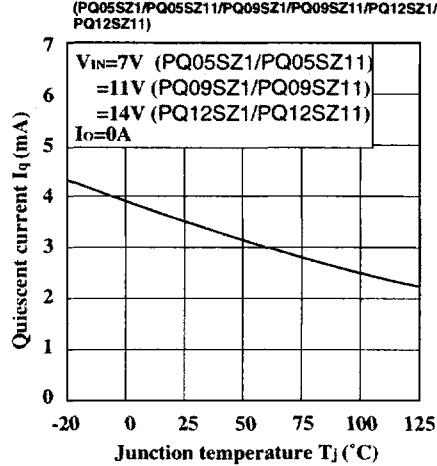

Fig.22 Ripple Rejection vs. Input Ripple Frequency

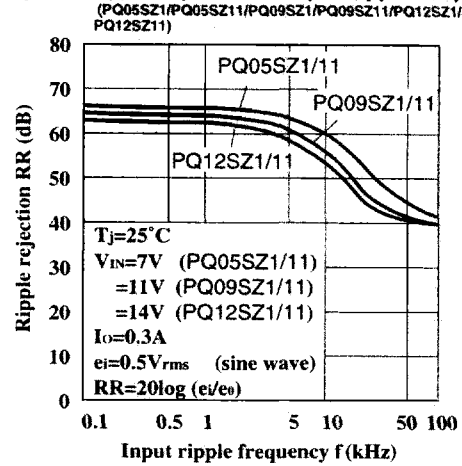

Fig.23 Ripple Rejection vs. Input Ripple Frequency

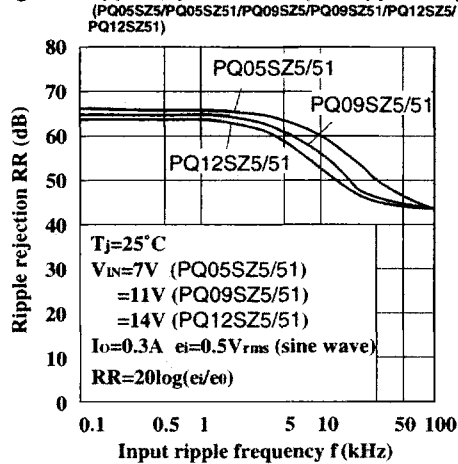

Fig.24 Ripple Rejection vs. Output Current

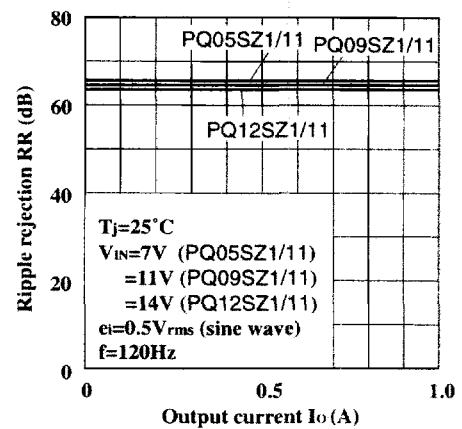

Fig.25 Ripple Rejection vs. Output Current

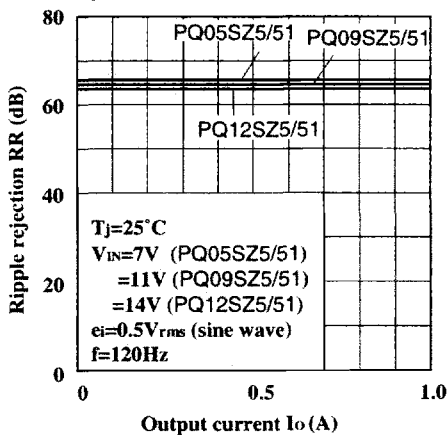

Fig.26 Input-Output Reverse Current vs. Input-Output Reverse Voltage

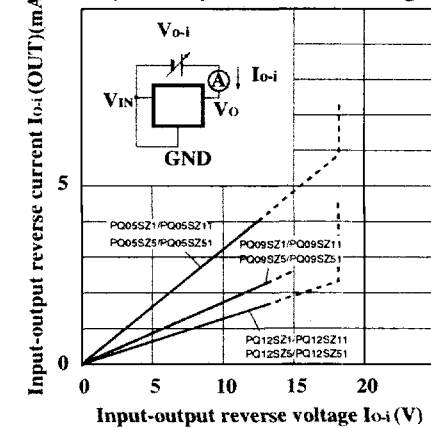

Fig.27 Power Dissipation vs. Ambient Temperature (Typical Value)

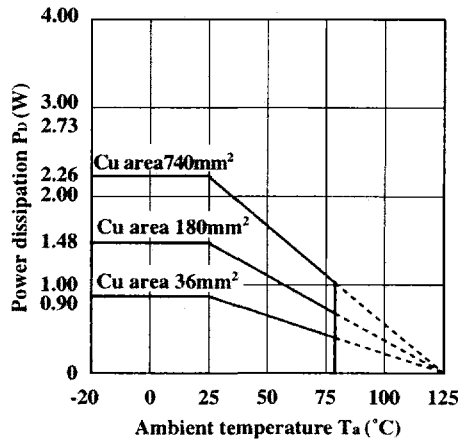
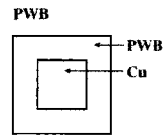
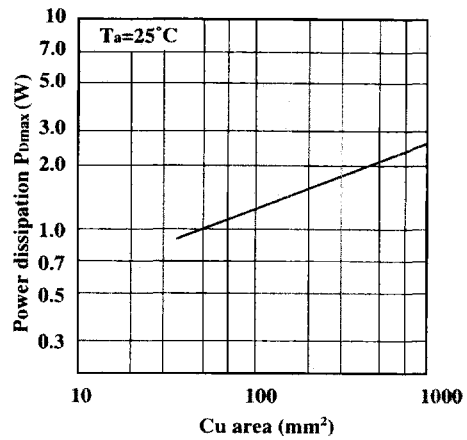

Fig.28 Power Dissipation vs. Cu Area



Material : Glass-cloth epoxy resin  
 Size : 50X50X1.6mm<sup>3</sup>  
 Cu thickness : 35μm

■ Model Line-ups for Tape-packaged Products

Output current	Sleeve-packaged products		Tape-packaged products	
	Standard type	High-precision output type	Standard type	High-precision output type
0.5A output	PQ05SZ5 Series	PQ05SZ51 Series	PQ05SZ5T Series	PQ05SZ5U Series
1.0A output	PQ05SZ1 Series	PQ05SZ11 Series	PQ05SZ1T Series	PQ05SZ1U Series