

LINEAR INTEGRATED CIRCUITS

PRELIMINARY DATA

OPERATIONAL AMPLIFIERS

The LS 709 series features low offset, high input impedance, large input common mode range, high output voltage swing. The amplifier is intended for use in D.C. servosystems, high impedance analog computer, low level instrumentation applications, and for the generation of special linear and non linear transfer functions.

ABSOLUTE MAXIMUM RATINGS

		TO-99	DIP
V_s	Supply voltage	± 18 V	
$V_i(1)$	Input voltage	± 10 V	
ΔV_i	Differential input voltage	± 5 V	
T_{op}	Operating temperature for LS 709/LS 709A for LS 709C	-55 to 125 °C 0 to 70 °C	
	Output short circuit duration (2)	5 s	
P_{tot}	Power dissipation at $T_{amb} = 70$ °C	520 mW	400 mW
T_{stg}	Storage temperature	-65 to 150 °C	-55 to 150 °C
	Lead soldering temperature	300 °C (10 s)	260 °C (12 s)

- 1) For supply voltages less than ± 10 V maximum input voltage is equal to the supply voltage
- 2) The short circuit duration is limited by thermal dissipation

MECHANICAL DATA

Dimensions in mm

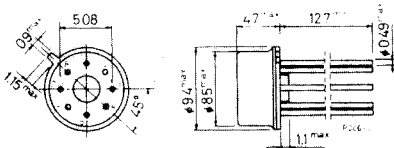

TO-99

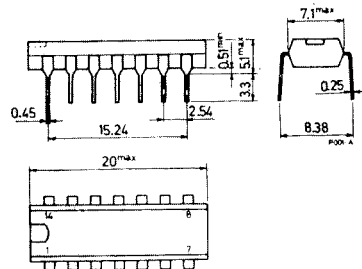

DIP

LS 709 LS 709A LS 709C

CONNECTION DIAGRAMS AND ORDERING NUMBERS (top views)

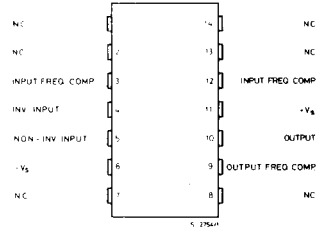
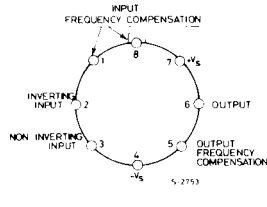

Type	TO-99	DIP
LS 709	LS 709T	—
LS 709A	LS 709 AT	—
LS 709C	LS 709 CT	LS 709 CB

SCHEMATIC DIAGRAM (pin numbers are referred to the TO-99 version)

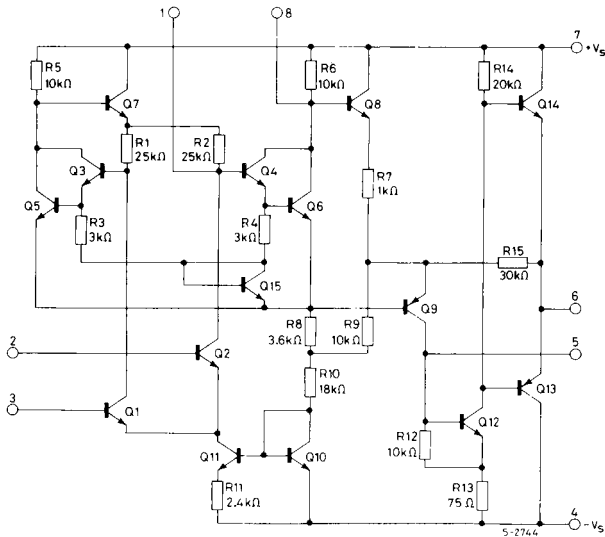

THERMAL DATA

	TO-99	DIP
$R_{th j-amb}$ Thermal resistance junction-ambient	max	155 °C/W
		200 °C/W

ELECTRICAL CHARACTERISTICS (see note)

Parameter	Test conditions	LS 709A			LS 709			LS 709C			Unit
		Min.	Typ.	Max.	Min.	Typ.	Max.	Min.	Typ.	Max.	
$ V_2 - V_3 $ Input offset voltage	$R_g \leq 10 \text{ k}\Omega$ $R_g \leq 10 \text{ k}\Omega$ $T_{amb} = 25^\circ\text{C}$		0.6	3 2		1	6 5		2	10 7.5	mV mV
I_b Input bias current	$T_{amb} = T_{min}$ $T_{amb} = 25^\circ\text{C}$		0.3 100	0.6 200		0.5 200	1.5 500		0.36 300	2 1500	μA nA
$ I_2 - I_3 $ Input offset current	$T_{amb} = T_{max}$ $T_{amb} = T_{min}$ $T_{amb} = 25^\circ\text{C}$		3.5 40 10	50 250 50		20 100 50	200 500 200		75 125 100	400 750 500	nA nA nA
R_i Input resistance	$T_{amb} = T_{min}$ $T_{amb} = 25^\circ\text{C}$	85 350	170 700		40 150	100 400		50 50	250 250		k Ω k Ω
R_o Output resistance	$T_{amb} = 25^\circ\text{C}$		150			150			150		Ω
I_s Supply current	$V_s = \pm 15\text{V}$ $T_{amb} = 25^\circ\text{C}$		2.5	3.6		2.6	5.5		2.6	6.6	mA
Transient response Risettime Overshoot	$V_i = 20 \text{ mV}$ $C_L \leq 100 \text{ pF}$ $T_{amb} = 25^\circ\text{C}$			1.5 30		0.3 10	1 30		0.3 10	1 30	μs %
SR Slew rate	$T_{amb} = 25^\circ\text{C}$		0.25			0.25			0.25		V/ μs
$\frac{\Delta V_2 - V_3 }{\Delta T}$ Average temperature coefficient of input offset voltage	$R_g = 50\Omega$ $T_{amb} = 25^\circ\text{C}$ to T_{max} $T_{amb} = 25^\circ\text{C}$ to T_{min} $R_g = 10 \text{ k}\Omega$ $T_{amb} = 25^\circ\text{C}$ to T_{max} $T_{amb} = 25^\circ\text{C}$ to T_{min}		1.8 1.8 2 4.3	10 10 15 25		3 6			6 12		$\mu\text{V}/^\circ\text{C}$ $\mu\text{V}/^\circ\text{C}$ $\mu\text{V}/^\circ\text{C}$ $\mu\text{V}/^\circ\text{C}$
G_v Large signal voltage gain	$V_s = \pm 15\text{V}$ $R_L \geq 2 \text{ k}\Omega$ $V_o = \pm 10\text{V}$	25		70	25	45	70	15	45		V/mV
V_o Output voltage swing	$V_s = \pm 15\text{V}$ $R_L = 10 \text{ k}\Omega$ $V_s = \pm 15\text{V}$ $R_L = 2 \text{ k}\Omega$	± 12 ± 10	± 14 ± 13		± 12 ± 10	± 14 ± 13		± 12 ± 10	± 14 ± 13		V V
V_i Input voltage range	$V_s = \pm 15\text{V}$	± 8			± 8	± 10		± 8	± 10		V
CMRR Common mode rejection ratio	$R_g \leq 10 \text{ k}\Omega$	80	110		70	90		65	90		dB
SVR Supply voltage rejection ratio	$R_g \leq 10 \text{ k}\Omega$		40	100		25	150		25	200	$\mu\text{V}/\text{V}$

Note: These specifications, unless otherwise specified, apply for $T_{amb} = -55$ to 125°C for LS 709/LS 709A and $T_{amb} = 0$ to 70°C for LS 709C with the following conditions: $V_s = \pm 9\text{V}$ to $\pm 15\text{V}$, $C_1 = 5000 \text{ pF}$, $R_1 = 1.5 \text{ k}\Omega$, $C_2 = 200 \text{ pF}$ and $R_2 = 51\Omega$. (See fig. 8 and fig. 17).

LS 709 LS 709A LS 709C

Fig. 1 - Voltage gain vs. supply voltage (for 709A)

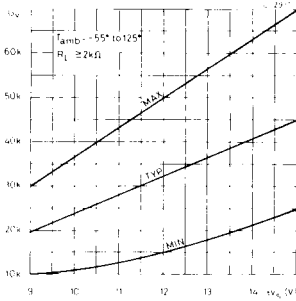

Fig. 2 - Output voltage swing vs. supply voltage (for 709A)

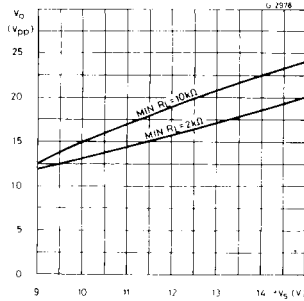

Fig. 3 - Input common mode voltage range vs. supply voltage (for 709A)

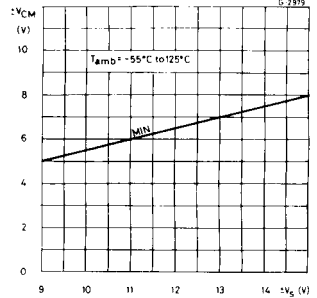

Fig. 4 - Power consumption vs. supply voltage (for 709A)

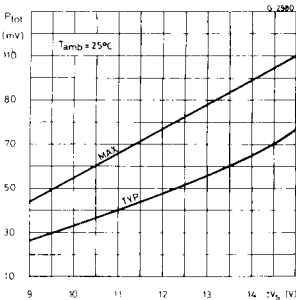

Fig. 5 - Output voltage swing vs. load resistance (for 709A)

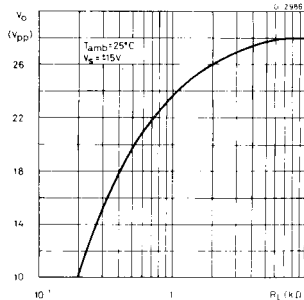

Fig. 6 - Input bias current vs. ambient temperature (for 709A)

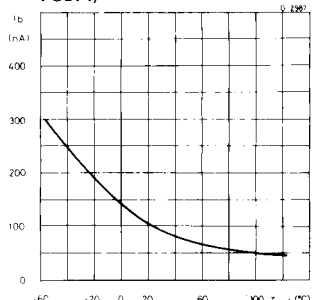

Fig. 7 - Input offset current vs. ambient temperature (for 709A)

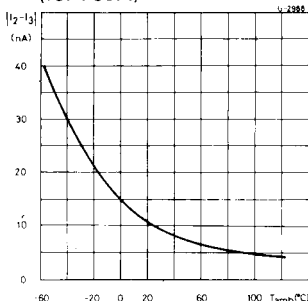

Fig. 8 - Transient response test circuit

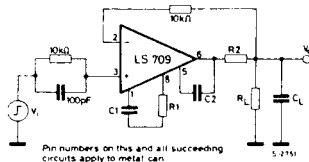
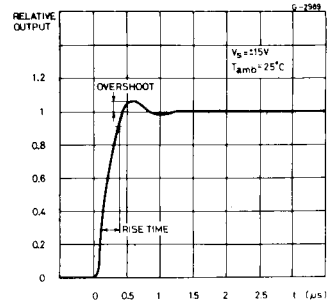

Fig. 9 - Transient response (for 709A)



LS 709 LS 709A LS 709C

Fig. 10 - Slew rate vs. closed loop gain using recommended compensation networks (for 709A)

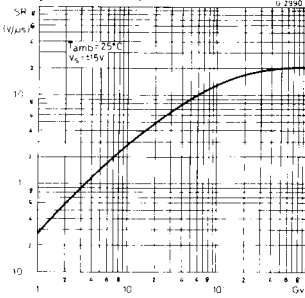

Fig. 11 - Voltage gain vs. supply voltage (for 709)

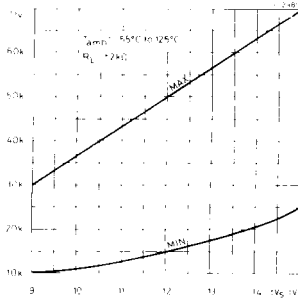

Fig. 12 - Output voltage swing vs. supply voltage (for 709 and 709C)

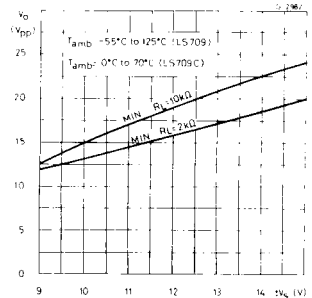

Fig. 13 - Voltage gain vs. supply voltage (for 709C)

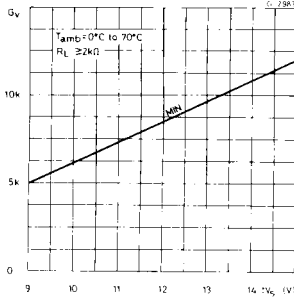

Fig. 14 - Input bias current vs. ambient temperature (for 709C)

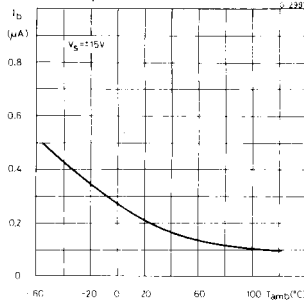
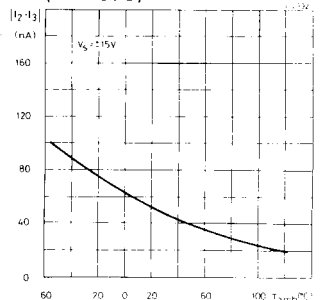

Fig. 15 - Input offset current vs. ambient temperature (for 709C)



Frequency compensation for all types

Fig. 16 - Open loop frequency response for various values of compensation

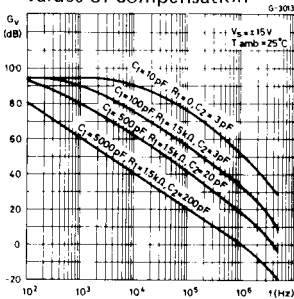

Fig. 17 - Frequency compensation circuit

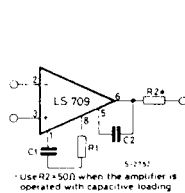
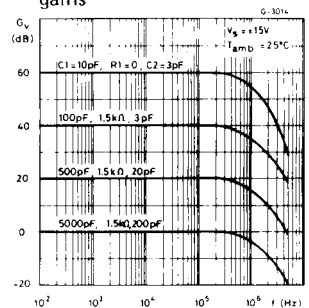

Fig. 18 - Frequency response for various closed loop gains



LS 709 LS 709A LS 709C

PROTECTION CIRCUITS

Fig. 19 - Output short circuit protection

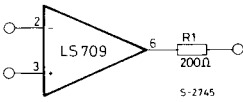

Fig. 20 - Input breakdown protection

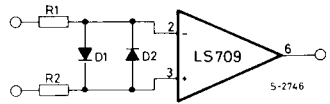

Fig. 21 - Latch up protection

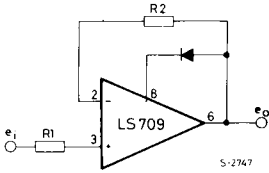

Fig. 22 - Supply overvoltage protection

